

# WHOLE EARTH CATALOG

*access to tools*



Fall 1968

\$5

## **FUNCTION**

*The WHOLE EARTH CATALOG functions as an evaluation and access device. With it, the user should know better what is worth getting and where and how to do the getting.*

*An item is listed in the CATALOG if it is deemed:*

- 1) Useful as a tool,*
- 2) Relevant to independent education,*
- 3) High quality or low cost,*
- 4) Not already common knowledge,*
- 5) Easily available by mail.*

*This information is continually revised according to the experience and suggestions of CATALOG users and staff.*

## **PURPOSE**

*We are as gods and might as well get good at it. So far, remotely done power and glory—as via government, big business, formal education, church—has succeeded to the point where gross defects obscure actual gains. In response to this dilemma and to these gains a realm of intimate, personal power is developing—power of the individual to conduct his own education, find his own inspiration, shape his own environment, and share his adventure with whoever is interested. Tools that aid this process are sought and promoted by the WHOLE EARTH CATALOG.*

# Understanding Whole Systems

Buckminster Fuller  
Cosmic View  
Full Earth  
Earth Photographs  
The World From Above  
Surface Anatomy  
Geology Illustrated  
Sensitive Chaos  
A Year From Monday

General Systems Yearbook  
Synthesis of Form  
On Growth and Form  
Tantra Art  
Psychological Reflections  
The Human Use of Human Beings  
The Ghost in the Machine  
The Year 2000  
The Futurist

# Shelter and Land Use

The Dymaxion World of Buckminster Fuller  
Space Structures  
Tensile Structures, Volume One  
Dome Cookbook  
Good News  
Architectural Design  
The Japanese House  
Audel Guides  
Alaskan Mill

Village Technology  
The Indian Tipi  
Tipis  
Aladdin Kerosene Lamps  
Man's Role in Changing the Face of the Earth  
Two Mushroom Books  
Organic Gardening  
ABC and XYZ of Bee Culture  
Universal Mill

# Industry and Craft

The Way Things Work  
Introduction to Engineering Design  
The Measure of Man  
Thomas Register of American Manufacturers  
New Scientist  
Scientific American  
Industrial Design  
Product Engineering  
Clearinghouse

Science and Civilization in China, Volume IV,  
Part 2  
Silvo Catalog  
Brookstone Tools  
Jensen Tools  
Miners Catalog  
Blasters' Handbook  
Direct Use of the Sun's Energy  
Structure, Form and Movement

Van Waters & Rogers  
Bookmaking  
Zone System Manual  
A Sculptor's Manual  
Creative Glass Blowing  
Buckskin  
Cut Beads  
Melrose Yarns

# Communications

Human Biocomputer  
The Mind of the Dolphin  
Information  
9100A Computer  
Cybernetics  
Eye and Brain  
Design for a Brain

Education Automation  
Intelligent Life in the Universe  
The McGraw-Hill Encyclopedia of Space  
Lafayette and Allied Catalogs  
Heathkit  
Modern Business Forms  
American Cinematographer

American Cinematographer Manual  
The Technique of Documentary Film Production  
The Technique of Television Production  
Auto Repair Manual  
Books  
Subject Guide to Books in Print  
Art Prints

# Community

The Modern Utopian  
The Realist  
Green Revolution  
Kibbutz: Venture in Utopia  
Duhe  
Groups Under Stress

The Merck Manual  
Land for Sale  
Consumer Reports  
Government Publications  
The Armchair Shopper's Guide  
How to Get 20% to 90% off on Everything You Buy

# Nomadics

Innovator  
The Retreater's Bibliography  
The Book of Survival  
The Survival Book  
Survival Arts of the Primitive Paiutes  
Camping and Woodcraft  
Light Weight Camping Equipment and How to Make It  
Backpacking  
L.L. Bean

Recreational Equipment  
Gerry Outdoor Equipment  
Kaibab Boots  
Hot Springs  
The Explorers Trademart Log  
National Geographic  
Sierra Club  
The Narrow Road to the Deep North  
Trout Fishing in America

# Learning

Toward a Theory of Instruction  
The Black Box  
THIS Magazine is about Schools  
Cuisenaire Rods  
ITA  
LIFE Science Library  
Kaiser Aluminum News  
700 Science Experiments for Everybody

Edmund Scientific  
WFF 'N PROOF  
Dr. Nim  
We Built Our Own Computers  
American Boys Handy Book  
Pioneer Posters  
Sense Relaxation  
Zen Flesh, Zen Bones

Meditation Cushions and Mats  
Self Hypnotism  
Psycho-cybernetics  
A Yaqui Way of Knowledge  
Fundamentals of Yoga  
The Act of Creation  
The I Ching



# CATALOG procedure

## Ordering from the CATALOG

The CATALOG functions primarily as a pointer rather than a seller and prefers to be absent from most of the transactions it encourages.

Address orders to the supplier given with the item unless you know of a better one [if you do, let us know]; if the price is not listed postpaid find out the postage or express cost from the supplier's location to yours [consult post office or express agency for rates]; add state tax if transaction is within your state; and send check or money order with your order.

If the supplier gives you poor service, let us know. That information can be added to his review.

Blank order envelopes are provided at the back of the CATALOG for your convenience and so that suppliers have some idea of the CATALOG's effect on their business — if strong enough it may result in price or service advantages to CATALOG users. Don't use the envelopes if you don't want to.

With some indicated items, books mostly, the CATALOG also will ship. There is no price difference with the service; the CATALOG gets the markup instead of the other guy, is all. For west coast orders it may mean faster service.

Generally, the closer the supplier is to you, the quicker and cheaper the shipping will be. If the item you're getting is at all delicate [Don Buchla tells us], or if you are in a hurry, air express is the best deal. REA mangles.

Anything overseas, do by air.

## Subscribing to the CATALOG

\$8.00 per year. This includes Fall and Spring issues of the CATALOG and four Supplements. Subscription forms are on page 63. Memorize your zip code.

## Suggesting

The validity of the information in the CATALOG is only as good as the transmitted experience of users. For any item, we have to

- Learn about it.
- Get thorough information on it, and
- Stay current with its changes and with the improvements of its competitors.

FROM YOUR EXPERIENCE  
HOW WOULD YOU ALTER  
per catalog  
per category  
per item

THIS CATALOG  
THESE ITEMS  
THIS REVIEW

## Reviewing

The CATALOG pays its reviewers \$10 an item for: getting familiar with the item, its usefulness, and its competition; evaluating the item; selecting samples of graphics or text (with page references) for the review; and writing a 200 — 300 word review.

Both reviewers and first suggestors of items are credited in the CATALOG.

We invite reviews that improve on present reviews or accompany suggestions for new items. On acceptance for publication reviewers will be paid \$10 per accepted review. Unused reviews will not be returned. Polish of submitted material is irrelevant unless it is meant to be camera-ready.

New items that have had some favorable comment, and that we want reviews for, will be listed in the Supplement.

## Corresponding

If the content of the WHOLE EARTH CATALOG is mostly products, the content of the Difficult But Possible Supplement is mostly processes.

Commentary from CATALOG users that is of general interest — and not a specific review — will be in the Supplement. Critical comments, new design processes, no-cash techniques, news of specific enterprises, useful fantasies, design student work, time and trouble shortcuts, new uses for common or exotic materials, other realms for the CATALOG to consider, etc., etc., — all welcome. The Supplement could wind up being more useful than the CATALOG.

## Advertising

Suppliers, manufacturers, creators of listed items are eligible to advertise in the CATALOG. They may advertise only an item listed or their own catalog. All ads are placed at the back of the book. There are no ads in the Supplement.

Rates:

full page \$ 200	\$ 75	
	\$ 25	\$ 10
		\$ 5

## Selling

The CATALOG and Supplement are available for resale at 50% discount — minimum order 5. Single copy list price of the CATALOG is \$5; the Supplement, \$2.

## Donating

Portola Institute, Inc. is a tax-exempt, non-profit corporation. Donations to Portola or the CATALOG may be deducted.

Retaining subscriptions to the CATALOG are \$25 for one year (\$17 tax deductible). Sustaining subscriptions are \$100+ per year (\$92+ tax deductible). Names of retaining and sustaining subscribers will be given in the CATALOG.

## CATALOG policy with suppliers and users

The CATALOG is under no obligation to suppliers. Users are under no obligation to the CATALOG.

Suppliers (manufacturers, creators, etc.) may not buy their way into the CATALOG. Free samples or other blandishments are cheerfully accepted by CATALOG researchers; response not predictable. No payment for listing is asked or accepted. We owe accurate information exchange to suppliers, but not favors.

Our obligation is to CATALOG users and to ourselves to be good tools for one another.

This Issue of the CATALOG, the first, is heavy on books because they are easy to start with (low cost, simple to get and evaluate). As more CATALOG users report in and we develop better facilities to try stuff out, later issues should contain more information on materials.

This issue of the CATALOG was prepared by:

Stewart Brand  
Sandra Tcherepnin  
Joe Bonner

with	Steve Baer
Jane Burton	Steve Durkee
James Fadiman	Ralph Metzner
Richard Raymond	Gurney Norman
Larry McCombs	Robert Albrecht

We are grateful to Ortega Park Teachers Laboratory for temporary use of their mountain idyll for production space.

The WHOLE EARTH CATALOG and Difficult But Possible Supplement to the WHOLE EARTH CATALOG is published at Portola Institute, 558 Santa Cruz, Menlo Park, California 94025 on the following schedule:

CATALOG	November
<u>Supplement</u>	January
<u>Supplement</u>	March
CATALOG	May
<u>Supplement</u>	July
<u>Supplement</u>	September

Preparation of the CATALOG was done on an IBM Selectric Composer and a Polaroid MP-3 camera with instant half-tone system. Nowel Publications, Menlo Park, printed the contents, and East Wind Printers, San Francisco, printed the cover.

Subscription rate: one year — \$8. Application to mail at second class postage rates is pending at Menlo Park, California.

**Buckminster Fuller**

The insights of Buckminster Fuller are what initiated this catalog.

Of the four books reviewed here, *Nine Chains to the Moon* is his earliest and most openly metaphysical, *Ideas and Integrities* his most personal, *No More Secondhand God* the most recent, *World Design Science Decade* the most programmatic.

People who beef about Fuller mainly complain about his repetition — the same ideas again and again, it's embarrassing. It is embarrassing, also illuminating, because the same notions take on different uses when re-approached from different angles or with different contexts. Fuller's lectures have a raga quality of rich nonlinear endless improvisation full of convergent surprises.

Some are put off by his language, which makes demands on your head like suddenly discovering an extra engine in your car — if you don't let it drive you faster, it'll drag you. Fuller won't wait. He spent two years silent after illusion language got him in trouble, and he returned to human communication with a redesigned instrument.

With that, empirical curiosity, and New England perseverance Fuller has forged one of the most original personalities and functional intellects of the age.

I see God in the instruments and the mechanisms that work reliably, more reliably than the limited sensory departments of the human mechanism.

And God says observe the paradox of man's creative potentials and his destructive tactics. He could have his new world through sufficient love for "all's fair" in love as well as in war which means you can junk as much rubbish, skip as many stupid agreements by love, spontaneous unselfishness radiant.

The revolution has come— set on fire from the top. Let it burn swiftly. Neither the branches, trunk, nor roots will be endangered. Only last year's leaves and the parasite-bearded moss and orchids will not be there when the next spring brings fresh growth and free standing flowers.

Here is God's purpose— for God, to me, it seems, is a verb not a noun, proper or improper; is the articulation not the art, objective or subjective; is loving, not the abstraction "love" commanded or entreated; is knowledge dynamic, not legislative code, not proclamation law, not academic dogma, not ecclesiastic canon. Yes, God is a verb, the most active, connoting the vast harmonic reordering of the universe from unleashed chaos of energy. And there is born unheralded a great natural peace, not out of exclusive pseudo-static security but out of including, refining, dynamic balancing. Naught is lost. Only the false and nonexistent are dispelled.

And I've thought through to tomorrow which is also today. The telephone rings and you say to me Hello Buckling this is Christopher; or Daddy it's Allegra; or Mr. Fuller this is the Telephone Company Business Office; and I say you are inaccurate. Because I knew you were going to call and furthermore I recognize that it is God who is "speaking."

And you say aren't you being fantastic? And knowing you I say no.

All organized religions of the past were inherently developed as beliefs and credits in "second hand" information.

Therefore it will be an entirely new era when man finds himself confronted with direct experience with an obviously a priori intellectually anticipatory competence that has interordered all that he is discovering.

[No More Secondhand God]

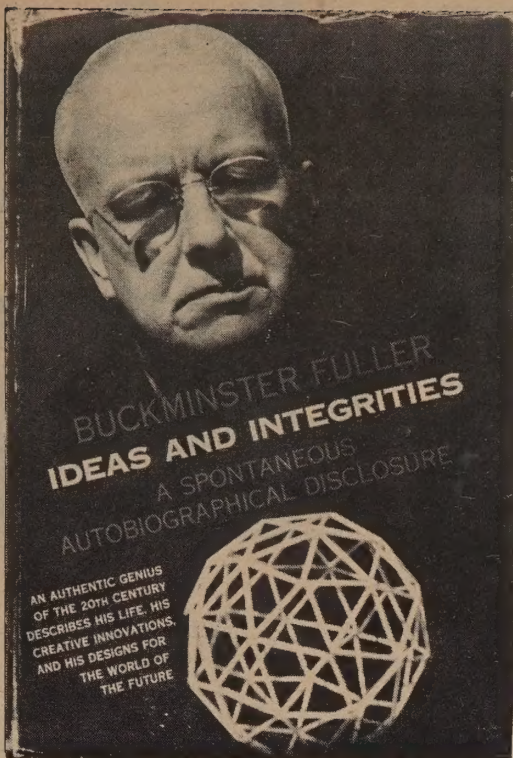

*Ideas and Integrities*  
Buckminster Fuller  
1963; 318 pp.

\$10.00 postpaid

from:  
Prentice-Hall, Inc.  
Englewood Cliffs  
New Jersey 07631  
or  
WHOLE EARTH CATALOG

Standing by the lake on a jump-or-think basis, the very first spontaneous question coming to mind was, "If you put aside everything you've ever been asked to believe and have recourse only to your own experiences do you have any conviction arising from those experiences which either discards or must assume an a priori greater intellect than the intellect of man?" The answer was swift and positive. Experience had clearly demonstrated an a priori anticipatory and only intellectually apprehensible orderliness of interactive principles operating in the universe into which we are born. These principles are discovered but are never invented by man. I said to myself, "I have faith in the integrity of the anticipatory intellectual wisdom which we may call 'God.'" My next question was, "Do I know best or does God know best whether I may be of any value to the integrity of universe?" The answer was, "You don't know and no man knows, but the faith you have just established out of experience imposes recognition of the a priori wisdom of the fact of your being." Apparently addressing myself, I said, "You do not have the right to eliminate yourself, you do not belong to you. You belong to the universe. The significance of you will forever remain obscure to you, but you may asume that you are fulfilling your significance if you apply yourself to converting all your experience to highest advantage of others. You and all men are here for the sake of other men."

[Ideas and Integrities]

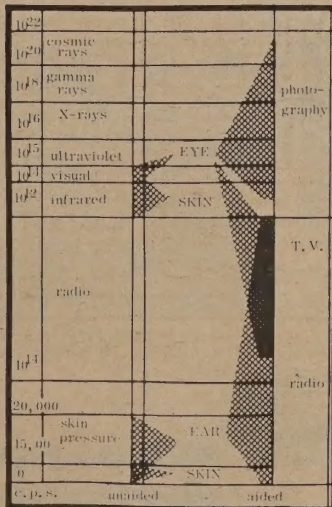

WSDS Document 1

World society has throughout its millions of years on earth made its judgements upon visible, tangible, sensorially demonstrable criteria. We may safely say that the world is keeping its eye on the unimportant visible 1 percent of the historical transformation while missing the significance of the 99 percent of overall, unseen changes. Forms are inherently visible and forms no longer can "follow functions" because the significant functions are invisible. . . .

There are very few men today who are disciplined to comprehend the totally integrating significance of the 99 percent invisible activity which is coalescing to reshape our future. There are approximately no warnings being given to society regarding the great changes ahead. There is only the ominous general apprehension that man may be about to annihilate himself. To the few who are disciplined to deal with the invisibly integrating trends it is increasingly readable in the trends that man is about to become almost 100 percent successful as an occupant of universe.

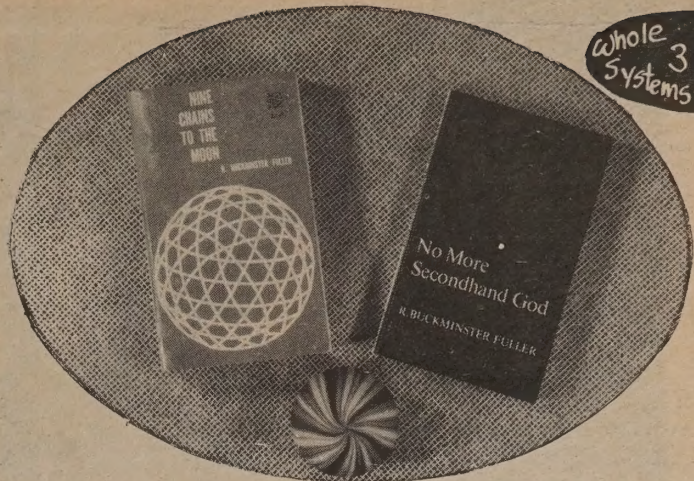

*Nine Chains to the Moon*  
Buckminster Fuller  
1938, 1963; 375 pp.

\$2.45 postpaid

*No More Secondhand God*  
Buckminster Fuller  
1963; 163 pp.

\$2.25 postpaid

both from:  
Southern Illinois University Press  
600 West Grand  
Carbondale, Illinois 62903  
or  
WHOLE EARTH CATALOG

Thinking is a putting-aside, rather than a putting-in discipline, e.g., putting aside the tall grasses in order to isolate the trail into informative viewability. Thinking is FM—frequency modulation—for it results in tuning-out of irrelevancies as a result of definitive resolution of the exclusively tuned-in or accepted feed-back messages' pattern differentiability.

[“Omnidirectional Halo” No More Secondhand God]

Common to all such "human" mechanisms—and without which they are imbecile contraptions—is their guidance by a phantom captain.

This phantom captain has neither weight nor sensorial tangibility, as has often been scientifically proven by careful weighing operations at the moment of abandonment of the ship by the phantom captain, i.e., at the instant of "death." He may be likened to the variant of polarity dominance in our bipolar electric world which, when balanced and unit, vanishes as abstract unity I or O. With the phantom captain's departure, the mechanism becomes inoperative and very quickly disintegrates into basic chemical elements.

This captain has not only an infinite self-identity characteristic but, also, an infinite understanding. He has furthermore, infinite sympathy with all captains of mechanisms similar to his. . . .

An illuminating rationalization indicated that captains—being phantom, abstract, infinite, and bound to other captains by a bond of understanding as proven by their recognition of each other's signals and the meaning thereof by reference to a common direction (toward "perfect")—are not only all related, but are one and the same captain. Mathematically, since characteristics of unity exist, they cannot be non-identical.

[Nine Chains to the Moon]

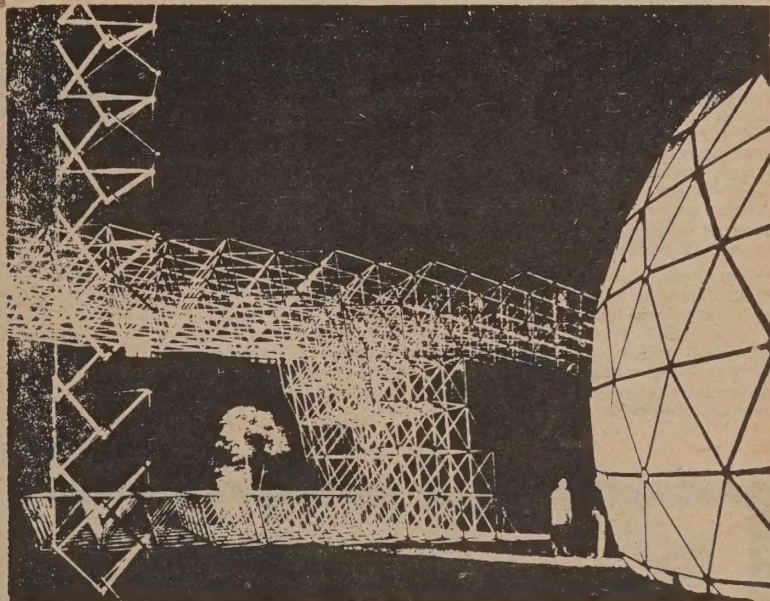

Our Air Force Redomes were installed in the arctic mostly by eskimos and others who had never seen them before. The mass production technology made assembly possible at an average rate of 14 hours each. One of these radomes was loaned by the U.S. Air Force to the Museum of Modern Art in New York City for an exhibition of my work in 1959-1960. It took regular building trades skilled labor one month to assemble the dome in New York City.

WSDS Document 2

I define 'synergy' as follows: Synergy is the unique behavior of whole systems, unpredicted by behavior of their respective sub-systems' events.

[Ideas and Integrities]

selfishness (self-preoccupation pursued until self loses its way and self-generates fear and spontaneous random surging, i.e. panic, the plural of which is mob outburst in unpremeditated wave synchronization of the individually random components)

[No More Secondhand God]

To start off with it is demonstrated in the array of events which we have touched on that we don't have to "earn a living" anymore. The "living" has all been earned for us forever. Industrialization's wealth is cumulative in contradistinction to the inherently terminal, discontinuous, temporary wealth of the craft eras of civilization such as the Bronze Age or Stone Age. If we only understood how that cumulative industrial wealth has come about, we could stop playing obsolete games, but that is a task that cannot be accomplished by political and social reforms. Man is so deeply conditioned in his reflexes by his milleniums of slave functioning that he has too many inferiority complexes to yield to political reformation. The obsolete games will be abandoned only when realistic, happier and more interesting games come along to displace the obsolete games.

[WDS Document 3]

Tension and Compression are complementary functions of structure. Therefore as functions they only co-exist. When pulling a tensional rope its girth contracts in compression. When we load a column in compression its girth tends to expand in tension. When we investigate tension and compression, we find that compression members, as you all know as architects, have very limited lengths in relation to their cross sections. They get too long and too slender and will readily break. Tension members, when you pull them, tend to pull, approximately, (almost but never entirely), straight instead of trying to curve more and more as do too thin compressionally loaded columns. The contraction of the tension members in their girth, when tensionally loaded, brings its atoms closer together which makes it even stronger. There is no limit ratio of cross section to length in tensional members of structural systems. There is a fundamental limit ratio in compression. Therefore when nature has very large tasks to do, such as cohering the solar system or the universe she arranges her structural systems both in the microcosm and macrocosm in the following manner. Nature has compression operating in little remotely positioned islands, as high energy concentrations, such as the earth and other planets, in the macrocosm; or as isolated electrons, or protons or other atomic nuclear components in the microcosm while cohering the whole universal system, both macro and micro, of mutually remote, compressional, and oft non-simultaneous, islands by comprehensive tension; — compression islands in a non-simultaneous universe of tension. The Universe is a tensegrity.

[WDS Document 2]

I was born cross-eyed. Not until I was four years old was it discovered that this was caused by my being abnormally farsighted. My vision was thereafter fully corrected with lenses. Until four I could see only large patterns, houses, trees, outlines of people with blurred coloring. While I saw two dark areas on human faces, I did not see a human eye or a tear drop or a human hair until I was four. Despite my new ability to apprehend details, my childhood's spontaneous dependence only upon big pattern clues has persisted. . . . .

I am convinced that neither I nor any other human, past or present, was or is a genius. I am convinced that what I have every physically normal child also has at birth. We could, of course, hypothesize that all babies are born geniuses and get swiftly de-geniused. Unfavorable circumstances, shortsightedness, frayed nervous systems, and ignorantly articulated love and fear of elders tend to shut off many of the child's brain capability valves. I was lucky in avoiding too many disconnects.

There is luck in everything. My luck is that I was born cross-eyed, was ejected so frequently from the establishment that I was finally forced either to perish or to employ some of those faculties with which we are all endowed—the use of which circumstances had previously so frustrated as to have to put them in the deep freezer, whence only hellishly hot situations could provide enough heat to melt them back into usability.

[WDS Document 5]

In the 1920's with but little open country highway mileage in operation, automobile accidents were concentrated and frequently occurred within our urban and suburban presence. Witnessing a number of accidents, I observed that warning signs later grew up along the roads leading to danger points and that more traffic and motorcycle police were put on duty. The authorities tried to cure the malady by reforming the motorista. A relatively few special individual drivers with much experience, steady temperament, good coordination and natural tendency to anticipate and understand the psychology of others emerged as "good" and approximately accident-free drivers. Many others were accident prone.

In lieu of the after-the-fact curative reform, trending to highly specialized individual offender case histories, my philosophy urged the anticipatory avoidance of the accident potentials through invention of generalized highway dividers, grade separators, clover leafing and adequately banked curves and automatic traffic control stop-lighting systems. I saw no reason why the problem shouldn't be solved by preventative design rather than attempted reforms. My resolve: Reshape environment; don't try to reshape man.

[WDS Document 1]

<p><b>WORLD DESIGN SCIENCE DECADE 1965-1975</b></p> <p>Phase I (1963) Document 1 INVENTORY OF WORLD RESOURCES HUMAN TRENDS AND NEEDS</p> <p>World Resources Inventory Southern Illinois University Carbondale, Illinois, U.S.A.</p>	<p><b>WORLD DESIGN SCIENCE DECADE 1965-1975</b></p> <p>Phase I (1964) Document 2 THE DESIGN INITIATIVE</p> <p>World Resources Inventory Southern Illinois University Carbondale, Illinois, U.S.A.</p>	<p><b>WORLD DESIGN SCIENCE DECADE 1965-1975</b></p> <p>Phase I (1965) Document 3 COMPREHENSIVE THINKING</p> <p>World Resources Inventory Southern Illinois University Carbondale, Illinois, U.S.A.</p>
<p><b>WORLD DESIGN SCIENCE DECADE 1965-1975</b></p> <p>Phase I (1965) Document 4 THE TEN YEAR PROGRAM</p> <p>World Resources Inventory Southern Illinois University Carbondale, Illinois, U.S.A.</p>	<p><b>WORLD DESIGN SCIENCE DECADE 1965-1975</b></p> <p>Phase II (1967) Document 5 COMPREHENSIVE DESIGN STRATEGY</p> <p>World Resources Inventory Southern Illinois University Carbondale, Illinois, U.S.A.</p>	<p><b>WORLD DESIGN SCIENCE DECADE 1965-1975</b></p> <p>Phase II (1967) Document 6 THE ECOLOGICAL CONTEXT: ENERGY AND MATERIALS</p> <p>World Resources Inventory Southern Illinois University Carbondale, Illinois, U.S.A.</p>



The Honeywell edition of Fuller's world map (more brightly colored than previous editions) is available for \$4.00 postpaid

from:  
P.O. Box 909  
Carbondale, Illinois 62901

However, man unconcernedly sorting mail on an express train with unuttered faith that the engineer is competent, that the switchmen are not asleep, that the track walkers are doing their job, that the technologists who designed the train and the rails knew their stuff, that the thousands of others whom he may never know by face or name are collecting tariffs, paying for repairs, and so handing assets that he will be paid a week from today and again the week after that, and that all the time his family is safe and in well being without his personal protection constitutes a whole new era of evolution—the first really 'new' since the beginning of the spoken word. In fact, out of the understanding innate in the spoken word was industrialization wrought after milleniums of seemingly whitherless spade work.

[The Unfinished Epic of Industrialization]

*The Unfinished Epic of Industrialization*  
Buckminster Fuller 1963; 227 pp

\$3.50 from World Resources Inventory  
Box 909, Carbondale, Illinois 62901

Concept Twelve — SELF DISCIPLINES

Working assumptions, cautions, encouragements, and restraints of intuitive formulations and spontaneous actions. My own rule: "Do not mind if I am not understood as long as I am not misunderstood."

**Personal Self Disciplining.** In 1927 I gave up forever the general economic dictum of society, i.e. that every individual who wants to survive must earn a living. I substituted, therefore, the finding made in concept one, i.e. the individual's antientropic responsibility in universe. I sought for the tasks that needed to be done that no one else was doing or attempting to do, which if done would physically and economically advantage society and eliminate pain.

As a consequence, it was necessary for me to discipline my faculties to develop technical and scientific capability to invent the physical innovations and their service industry logistics.

My Recommendations for a Curriculum of Design Science:

1. Synergetics
2. General Systems Theory
3. Theory of Games (Von Neumann)
4. Chemistry and Physics
5. Topology, Projective Geometry
6. Cybernetics
7. Communications
8. Meteorology
9. Geology
10. Biology
11. Sciences of Energy
12. Political Geography
13. Ergonomics
14. Production Engineering

[WDS Document 5]

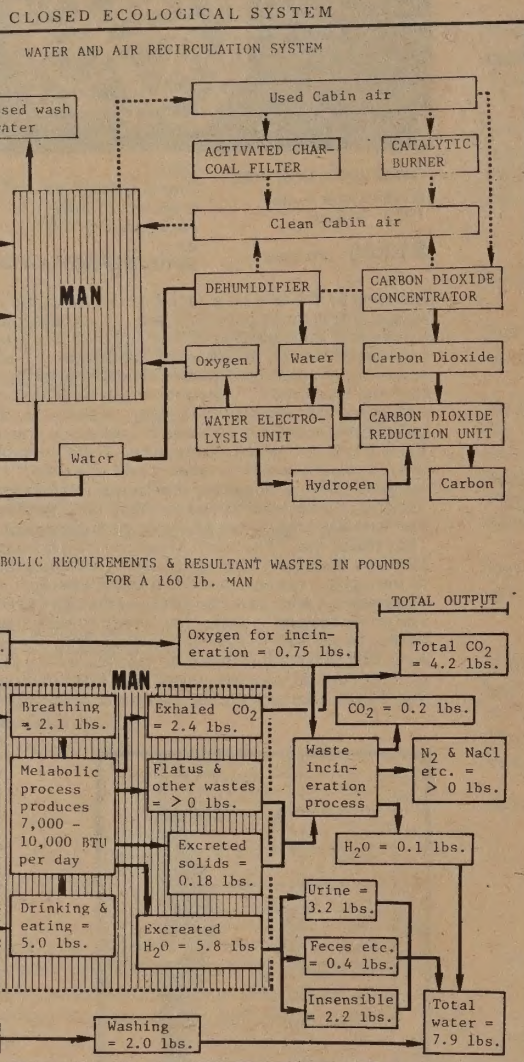

Sources: (1) E. S. Mills, R. L. Buterton, Douglas Missile & Space Systems Development Interplanetary Mission Life Support System, 1965. (2) NASA: ASD Report TR 61-363.

WDS Document 6

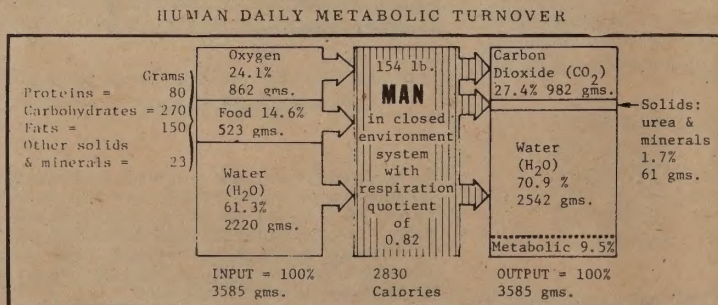

Source: Apogee, Douglas Missile & Space Publication No. 4, 1961. p. 8.

The *World Design Science Decade* documents contain some that is in the other books and much that isn't. The 6 volume set costs \$10.50 postpaid to students (formal and informal); \$30.00 postpaid to others. This is a very good deal.

We find that original question asking is a consequence of interferences, whether in the computer or the human brain. We find then that original questions are second derivative events in the computer life.

[WDS Document 2]

Order from:  
World Resources Inventory Office  
P.O. Box 909  
Carbondale, Illinois 62901  
or WHOLE EARTH CATALOG  
Size: 35 x 20 inches

The will of history reads "for everybody or for nobody," and since we balk at "for nobody" it has to be "for everybody". And that's the way it is going, lickety-split and the world around.

[WDS Document 3]

### Cosmic View

"The Universe in 40 Jumps" is the subtitle of the book. It delivers.

The man who conceived and rendered it, a Dutch schoolmaster named Kees Boeke, gave years of work to perfecting the information in his pictures. The result is one of the simplest, most thorough, inescapable mind blows ever printed. Your mind and you advance in and out through the universe, changing scale by a factor of ten. It very quickly becomes hard to breathe, and you realize how magnitude-bound we've been.

I'm amazed this book isn't more commonly available. It's the best seller of The Whole Earth Truck Store. People get it for their friends.

Cosmic View  
Kees Boeke  
1957; 48 pp.

from:  
The John Day Company  
62 West 45th Street  
New York, N.Y.  
or  
WHOLE EARTH CATALOG

\$3.75 postpaid

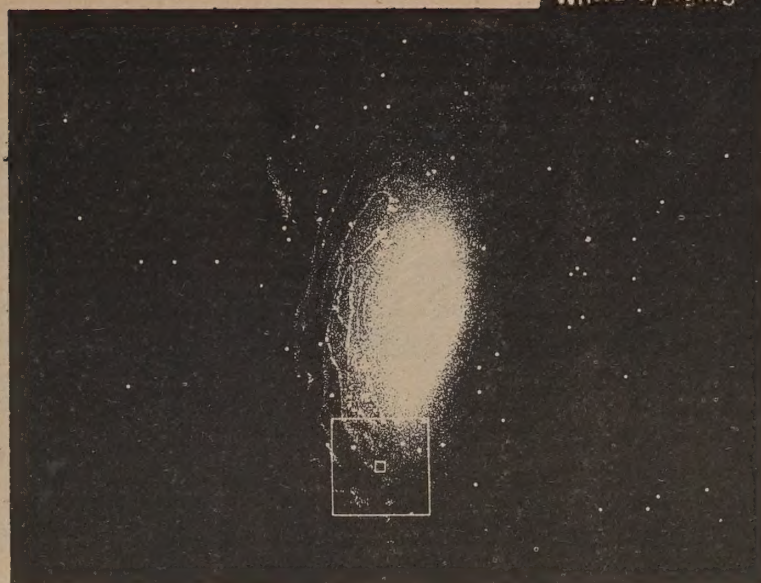
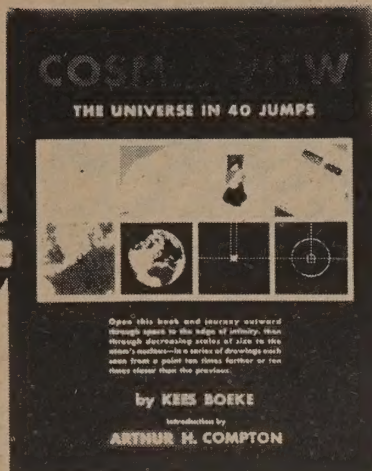

### Full Earth

In November 1967 an ATS satellite whose funds phenomenally had not been cut made a home movie. It was a time lapse film of the Earth rotating, shot from 23,000 miles above South America. (This is synchronous distance. The satellite orbits at the same speed the Earth turns, so it remains apparently stationary over one point of the equator.) Color photographs of the Earth were transmitted by TV every 1/2 hour to make up a 24 hour sequence. The shots

were lap dissolved together to make the movie. You see darkness, then a crescent of dawn, then advancing daylight and immense weather patterns whorling and creeping on the spherical surface, then the full round mandala Earth of noon, then gibbous afternoon, crescent twilight, and darkness again.

A 16mm 400-foot silent color print of the film includes several forms of the 24-hour cycle and close-up cropping of specific sectors as their weather develops through the day.

The film (NR 68-713) costs

\$48.94 plus shipping

from:  
Byron Motion Pictures  
65 K Street NE  
Washington, D.C. 20002

An 8 x 10 color print of the

full earth (68-HC-74) costs

\$5.64 postpaid

from:  
Creative Arts Studio, Inc.  
814 H Street, NW  
Washington, D.C. 20001

Color Posters (22 x 27) of the full earth photographs may be ordered from the WHOLE EARTH CATALOG for

\$2.00 postpaid.

The posters are available for resale (minimum order 5) at 50% discount.

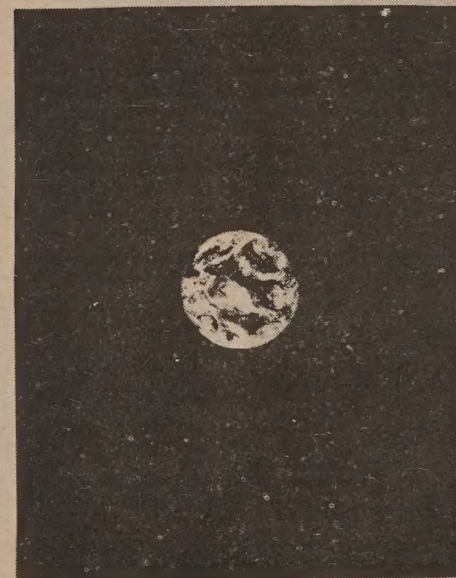

### Earth Photographs

NASA SP. 129 is a hell of a book. Two hundred forty-three full page color photographs of our planet from the Gemini flights of 1965. If it were a Sierra Club book, and it could be, it would cost \$25. It costs \$7.

There are numerous discoveries in the book. One is that this beautiful place is scarcely inhabited at all.



Earth Photographs from Gemini III, IV, and V.

NASA  
1967; 266 pp.

\$7.00 postpaid

from:  
Superintendent of Documents  
U.S. Government Printing Office  
Washington, D.C. 20402  
or  
WHOLE EARTH CATALOG



A second photograph of California's Imperial Valley giving a clear view of the Salton Sea. No agreement exists concerning the cause of the gyre seen in the center of the sea.

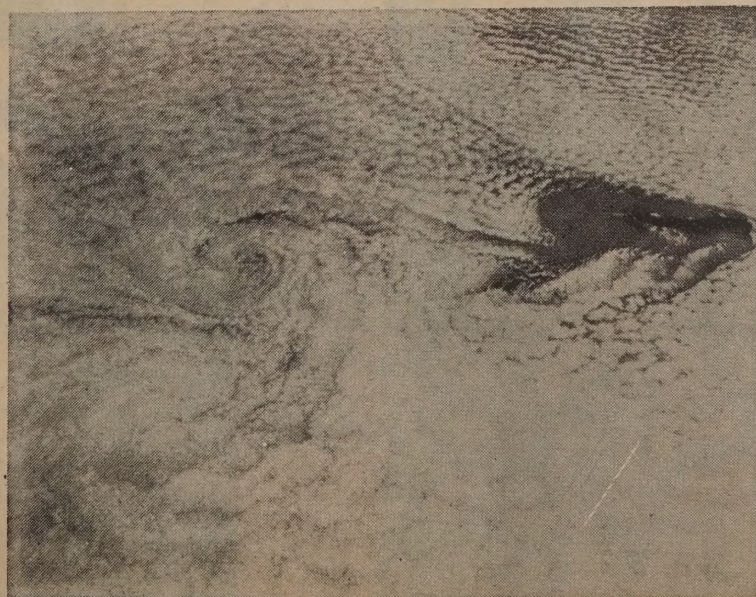

Close-up glamor shots of the Earth. Mystery shots (What is that? What's our altitude above it, 10 feet or 10,000?) (Fold out captions tell all.) Good traffic flow pattern shots: surface anatomy of civilization. Not a bad compendium; it'll do until they reprint E.A. Gutkind's Our World From the Air.

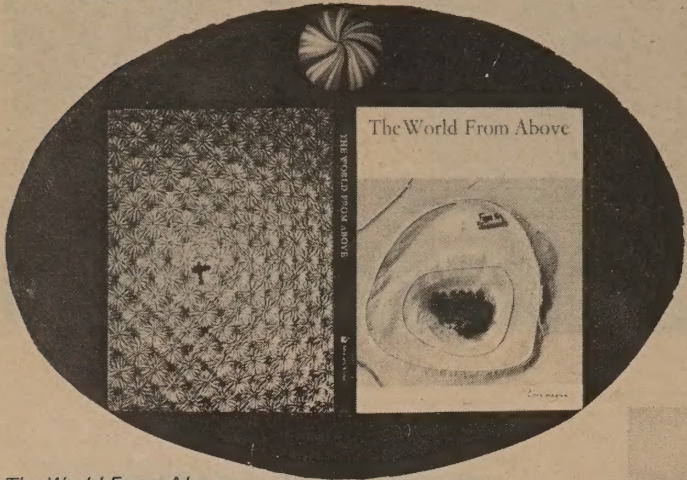

The World From Above

Hanns Reich  
1966; 88 pictures

\$7.50 postpaid

from:  
Hill and Wang, Inc.  
141 Fifth Avenue  
New York, N.Y. 10010  
or  
WHOLE EARTH CATALOG

Surface Anatomy

This book is included as a companion piece to the Earth picture books. The whole lovely system of the human creature, seen from without, surface by surface, is here. One of its main revelations is how cliché ridden our usual views of ourselves are — we are still not good with mirrors (satellites were up 10 years before we got a full view of the Earth). Posing friends and neighbors, with a simple light set-up and a 35mm camera, Joseph Royce has shot the most beautiful human album I know.

It also teaches anatomy.

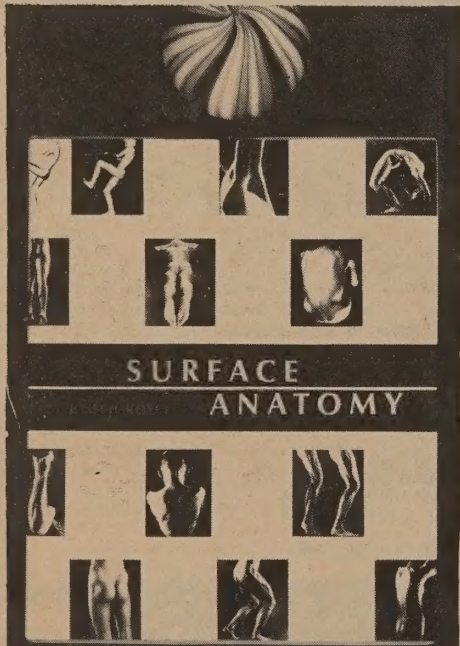

Surface Anatomy

Joseph Royce  
1965; 124 photographs  
and some diagrams

\$12.50 postpaid

from:  
F.A. Davis Company  
1914 Cherry Street  
Philadelphia, Pa 19103  
or  
WHOLE EARTH CATALOG

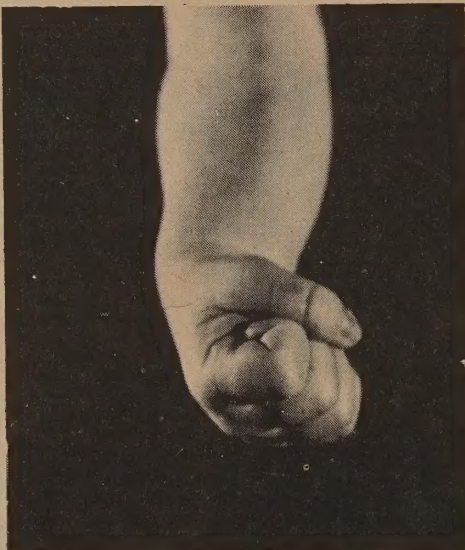
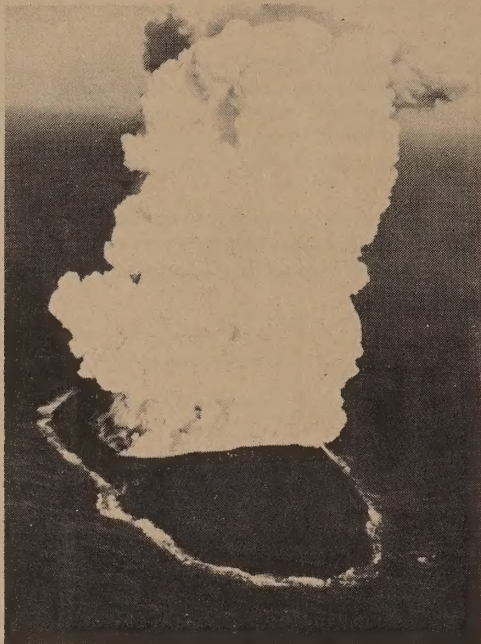



**Geology Illustrated**

A artist of aerial photography, Shelton uses some 400 of his finest photos to illuminate a discussion of the whole-earth system. Not a traditional textbook, but a fascinating exploration of the problems posed by asking "How did that come about?" Worth buying for the photos and book design alone, but you'll probably find yourself becoming interested in geology regardless of your original intentions.

[Reviewed by Larry McCombs]

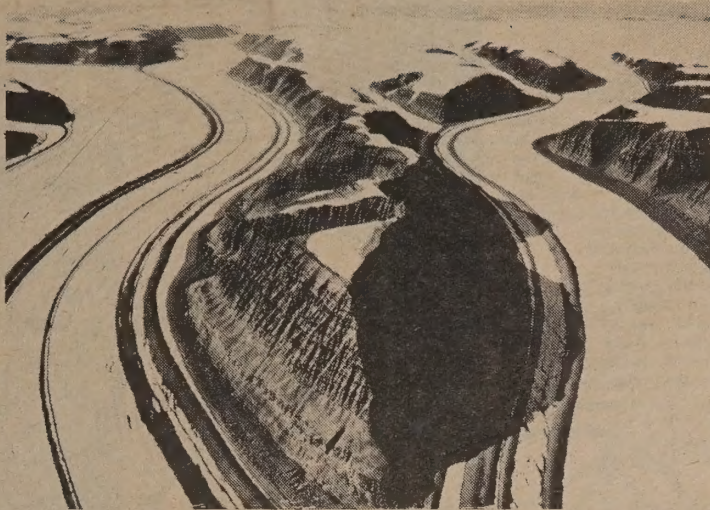

As a means of communicating geological concepts, the pictures are fully as important as the words that accompany them. On most pages the photographs represent the facts, the words supply the interpretation. Many of the illustrations will, therefore, repay a little of the kind of attention that would be accorded the real feature in the field. In keeping with this, almost no identifying marks have been placed on the photographs and very few on the drawings. The text (which almost invariably concerns an illustration on the same or a facing page) serves as an expanded legend for the picture; if, while reading it, it is necessary to look more than once to identify some feature with certainty, this is no more than Nature asks of those who contemplate her unlabelled cliffs and hills.

*Geology Illustrated*  
John S. Shelton  
1966; 434 pp.

\$10.00 postpaid

from:  
W. H. Freeman & Company  
660 Market Street  
San Francisco, Ca 94104  
or  
WHOLE EARTH CATALOG

Whole 7 Systems

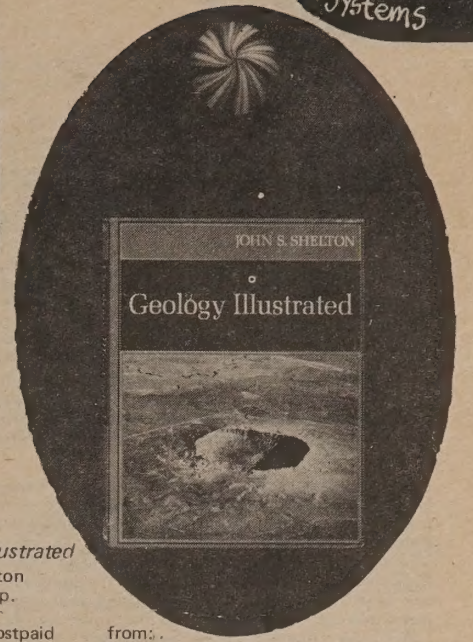

**Sensitive Chaos**

Schwenk directs an institute in the Black Forest devoted to the study of the movements of water and air. Within the last few centuries, he says we have "lost touch with the spiritual nature of water." As a result, we have attempted to control the fluids in ways contrary to their nature, and the results are evident in the problems of pollution, damage to the ecosystem, and even drying up of natural water sources. Schwenk attempts to penetrate beyond the mere observable phenomena to an ability to "read" the true spiritual nature of flowing substances.

I found the book to be a peculiarly fascinating mixture of overgeneralization, simplification, undifferentiated fact and theory, and shrewd observation and insight. If you regard analogy as the weakest form of argument, this book is definitely not for you. On the other hand, Schwenk's juxtaposition of similar forms in different flowing media may spark some exciting bisociations, if you are open to them. The section of 88 pages of black and white photos at the back of the book could stand alone as a beautiful art collection.

[Reviewed by Larry McCombs]

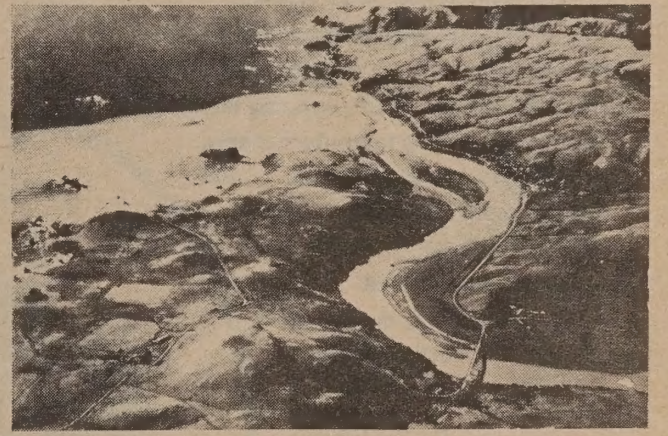
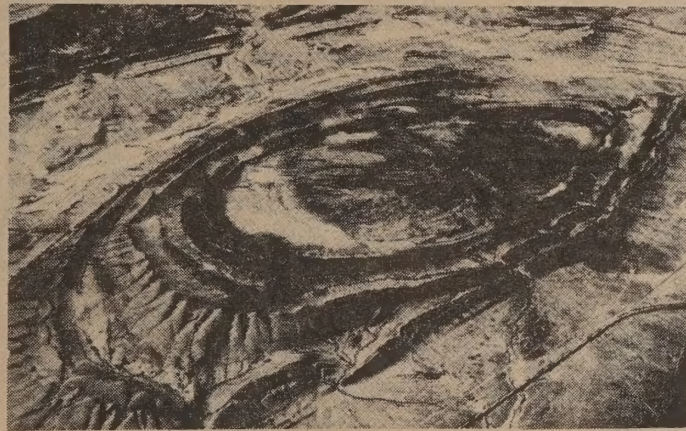

Here too the form of the vortex seems to hover invisibly over the growth processes, even before the horns are actually there, for they proceed along this spiral path with mathematical exactitude in their annual growth. It is significant that the axes of the two spiralling horns meet either in the nose or the eyes or in their immediate vicinity, a fact which stresses the strong connection of the horns with sense perception and with the animal's sense of its surroundings. Furthermore, in structure, the horn, like the water vortex, is finely laminated, layer upon layer.

*Sensitive Chaos*

Theodor Schwenk  
1965; 144 pp. 88 plates

\$12.00 [Air postpaid]

from:  
Rudolf Steiner Press  
35 Park Road  
London NW 1  
England

or

\$8.70 [postpaid]

from:  
WHOLE EARTH CATALOG

The question is: Is my thought changing? It is and it isn't. One evening after dinner I was telling friends that I was now concerned with improving the world. One of them said: I thought you always were. I then explained that I believe—and am acting upon—Marshall McLuhan's statement that we have through electronic technology produced an extension of our brains to the world formerly outside of us. To me that means that the disciplines, gradual and sudden (principally Oriental), formerly practiced by individuals to pacify their minds, bringing them into accord with ultimate reality, must now be practiced socially—that is, not just inside our heads, but outside of them, in the world, where our central nervous system now is. This has brought it about that the work and thought of Buckminster Fuller is of prime importance to me. He more than any other to my knowledge sees the world situation—all of it—clearly and has fully reasoned projects for turning our attention away from "killingry" toward "livingry."

Coming back to the notion that my thought is changing. Say it isn't. One thing, however, that keeps it moving is that I'm continually finding new teachers with whom I study. I had studied with Richard Gehlig, Henry Cowell, Arnold Schoenberg, Daisetz Suzuki, Guy Nearing. Now I'm studying with N.O. Brown, Marshall McLuhan, Buckminster Fuller, Marcel Duchamp. In connection with my current studies with Duchamp, it turns out I'm a poor chessplayer. My mind seems in some respect lacking, so that I make obviously stupid moves. I do not for a moment doubt that this lack of intelligence affects my music and thinking generally. However, I have a redeeming quality: I was gifted with a sunny disposition.



A Year From Monday

John Cage  
1967; 167pp.  
\$7.92 postpaid

from:  
Wesleyan University Press  
Middletown, Conn. 06457  
or  
WHOLE EARTH CATALOG

Everything we come across is to the point. Living underground because there was no money. Arizona land and air permitted making mounds, covering them with cement, excavating to produce rooms, providing these with skylights. For anyone approaching, the community was invisible. Cacti, desert plants: the land seemed undisturbed. Quantity (abundance) changes what's vice, what's virtue. Selfishness is out; carelessness is in. (Waste's

to wait. XXXVI. Weather feels good. Isn't. More rain is needed. Water. He played two games, winning one, losing the other. He was continually himself, totally involved in each game, unmoved by the outcome of either. What's the nature of his teaching? For one thing: devotion (practice gives evidence of it). For another: not just playing half the game but playing all of it (having a view that includes that of the opponent). Suddenly a clam rose to

consciousness. "They think 'world'... Theirs will be the most powerful and constructive revolution in all history."]  
LIV. More we leave the land, the more productive it becomes. Technique for changing society: education followed by unemployment. Article by Avner Hovne on automation (Impact of Science on Society 15:1, Unesco publication).  
Continuity values giving way to flexibility values. Automation alters what's done and where we do it. You could always tell when she was about to go out of her mind. She would begin to speak the truth. April '64: fifty-five global



## General Systems Yearbook

General systems theory was introduced by biologist Ludwig von Bertalanffy some years back (one application has been systems analysis, which has recomprehended and redesigned much of business, technology, education, etc.). The General Systems Yearbook is edited by Bertalanffy and Anatol Rapoport

By definition General Systems is a mixed bag. Kinds of systems covered in the Yearbook include Biological, Social, Psychological, Games, Linguistic, Political, Cybernetic and Meteorological. Throughout is the search for common dynamics that transcend them all. It's technical, mathematical business, heavy reading, and maybe trivial, maybe wishful; but every here and there is a gleam of something that might be a window into broad mindscapes.

The current volume of the Yearbook (1967) is Volume XII. Titles of articles, working back as far as we have space, are:

The price of the Yearbook is  
**\$10.00** for recent volumes,  
**\$7.50** for earlier ones.  
Consolidated contents booklet available free.

from:  
Society for General Systems Research  
Box 228  
Bedford, Mass. 01730

### VOLUME IX (1964)

Sociometry and the Physical Sciences  
Prediction in Physics and the Social Sciences  
The Concept of Entropy in Landscape Evolution  
Geomorphology and General Systems Theory  
An Approach to the Conceptual Analysis of Scientific Crises  
A Survey of General Systems Theory  
The Set Theory of Mechanism and Homeostasis  
Constraint Analysis of Many-Dimensional Relations  
The Domain of Adaptive Systems: A Rudimentary Taxonomy  
Language Description of Concepts  
Some Simple Models of Arms Races  
The Problem of Systemic Organizations in Theoretical Biology  
The Conceptual Formulation and Mathematical Solution of Practical Problems in Population Input-Output Dynamics  
The Use of Mathematics and Computers to Determine Optimal Strategies for a Given Insect Pest Control Problem

### VOLUME X (1965)

The Logic of Systems: An Introduction to a Formal Theory of Structure  
The General System as a Methodological Tool  
Systems Theory from an Operations Research Point of View  
Similar Problems in Meteorology and Psychology  
The Architecture of Complexity  
On the Emergence of Patterns of Order  
On the Stability of Brain-Like Structures  
Some Considerations on the Notion of Invariant Field in Linguistics  
Toward a Unifying Theory of Cognition  
Contributions to Stochastic Learning Theory  
Aspiration Levels and Utility Theory  
Concession-Making in Experimental Conditions  
Wheat on Kilimanjaro: The Perception of Choice Within Game and Learning Model Frameworks  
Models of Southern Kwakiutl Social Organization  
A Field Theory of Social Action with Application to Conflict

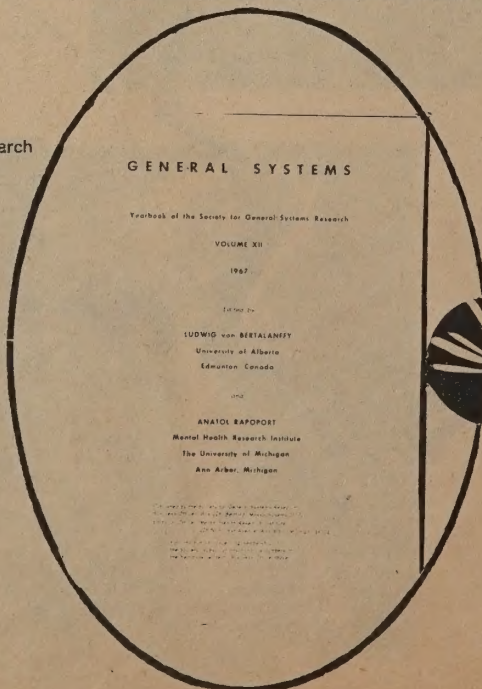

### VOLUME XI (1966)

Mathematical Aspects of General Systems Theory  
Toward a Theory of Parts and Wholes: An Algebraic Approach  
Meteorology and the Social Sciences: Further Comparisons  
Methodological Problems of System Research  
Metaorganization of Information  
The Insect Corneal Nipple Array  
The Wholeness of Living Systems and Some Basic Biological Problems  
On the Origin of Order in Behavior  
A Cognitive Approach to the Analysis of Cultures and Cultural Evolution  
The University Community System—Self Regulated Bearer of Meaning  
A Condensation in Warpeace Space  
On Some General Categories of Linguistics  
The Theory of Meta-Games  
The Mathematics of Meta-Games  
Benevolence in Game Theory  
A Taxonomy of 2 x 2 Games  
An Analysis of Duopoly Bargaining  
Two Motivations for Defection in Prisoner's Dilemma Games  
Empirical Approaches to Game Theory and Bargaining: a Bibliography

### VOLUME XII (1967)

The Evolution of the Human Brain: Some Notes Toward a Synthesis Between Neural Structure and the Evolution of Complex Behavior  
Organismic Sets: Outline of a General Theory of Biological and Social Organisms  
The Orderliness of Biological Systems  
Colony Development of a Polymorphic Hydroid as a Problem in Pattern Formation  
A Geometric Model with Some Properties of Biological Systems  
The Regulation of Political Systems  
Types of Asymmetry in Social and Political Systems  
A Quantitative Approach to the Dynamics of Perception  
Some Psychological Aspects of Psychometry  
A Further Extension of General Systems Theory for Psychiatry  
A Dynamic Model of the Conflict Between Criminals and Society  
Some Comparisons Between Traffic Deaths and Suicide  
Crime Rate vs. Population Density in United States Cities: A Model  
Simulation of Socio-Economic Systems  
An Empirical Test of Five Assumptions in an Inter-Nation Simulation, About National Political Systems

Synthesis of Form

Christopher Alexander is a design person that other design people refer to a lot. This book deals with the nature of current design problems that are expanding clear beyond any individual's ability to know and correlate all the factors. The methodology presented here is one of analysis of a problem for misfits and synthesis of form (via computer-translatable nets and hierarchies) for minimum misfits.

[from the table of contents]

- 2. Goodness of Fit 15
- 3. The Source of Good Fit 28
- 4. The Unselfconscious Process 46
- 5. The Selfconscious Process 55

But if we think of the requirements from a negative point of view, as potential misfits, there is a simple way of picking a finite set. This is because it is through misfit that the problem originally brings itself to our attention. We take just those relations between form and context which obtrude most strongly, which demand attention most clearly, which seem most likely to go wrong. We cannot do better than this. If there were some intrinsic way of reducing the list of requirements to a few, this would mean in essence that we were in possession of a field description of the context: if this were so, the problem of creating fit would become trivial, and no longer a problem of design. We cannot have a unitary or field description of a context and still have a design problem worth attention.

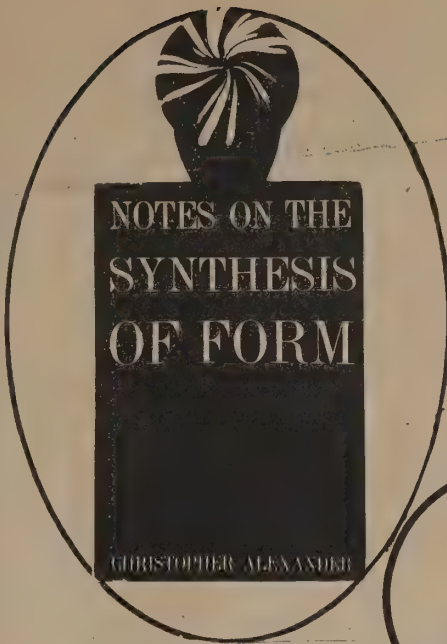

Notes on the Synthesis of Form

Christopher Alexander  
1964; 216 pp.

\$6.75 postpaid

from:  
Harvard University Press  
79 Garden Street  
Cambridge, Mass 02138

or  
WHOLE EARTH CATALOG

Indeed, not only is the man who lives in the form the one who made it, but there is a special closeness of contact between man and form which leads to constant rearrangement of unsatisfactory detail, constant improvement. The man, already responsible for the original shaping of the form, is also alive to its demands while he inhabits it. And anything which needs to be changed is changed at once.

A subsystem, roughly speaking, is one of the obvious components of the system, like the parts shown with a circle round them. If we try to adjust a set of variables which does not constitute a subsystem, the repercussions of the adjustment affect others outside the set, because the set is not sufficiently independent. The procedure of the unselfconscious system is so

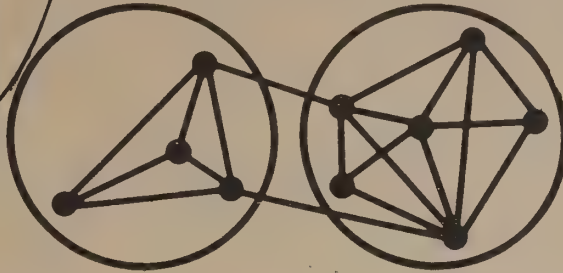

organized that adjustment can take place in each one of these subsystems independently. This is the reason for its success.

In the selfconscious situation, on the other hand, the designer is faced with all the variables simultaneously

The greatest clue to the inner structure of any dynamic process lies in its reaction to change.

The Mousgoum cannot afford, as we do, to regard maintenance as a nuisance which is best forgotten until it is time to call the local plumber. It is in the same hands as the building operation itself, and its exigencies are as likely to shape the form as those of the initial construction.

The selfconscious individual's grasp of problems is constantly misled. His concepts and categories, besides being arbitrary and unsuitable, are self-perpetuating. Under the influence of concepts, he not only does things from a biased point of view, but sees them biasedly as well. The concepts control his perception of fit and misfit—until in the end he sees nothing but deviations from his conceptual dogmas, and loses not only the urge but even the mental opportunity to frame his problems more appropriately.

The solution of a design problem is really only another effort to find a unified description. The search for realization through constructive diagrams is an effort to understand the required form so fully that there is no longer a rift between its functional specification and the shape it takes.

Two misfits are seen to interact only because, in some sense at least, they deal with the same kind of physical consideration. . . . It is such a physical center of implication, if I may call it that, which the designer finds it easy to grasp. Because it refers to a distinguishable physical property or entity, it can be expressed diagrammatically, and provides a possible non-verbal point of entry into the problem.

On Growth and Form

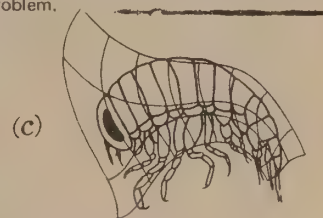
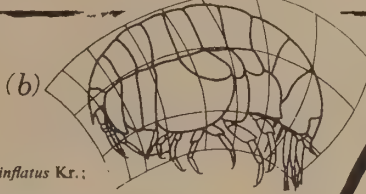

Fig. 143. (a) *Harpinia plumosa* Kr.; (b) *Stegocephalus inflatus* Kr.; (c) *Hyperia galba*.

A paradigm classic. Everyone dealing with growth or form in any manner can use the book. We've seen worn copies on the shelves of artists, inventors, engineers, computer systems designers, biologists. Would one of you do a thorough review of D'Arcy Thompson's venerable book for the CATALOG?

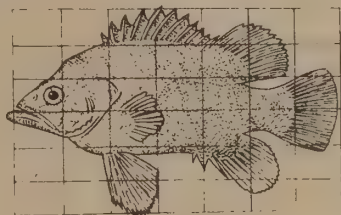

Fig. 150. *Polyprion*.

Fig. 151. *Pseudopacanthus altus*.

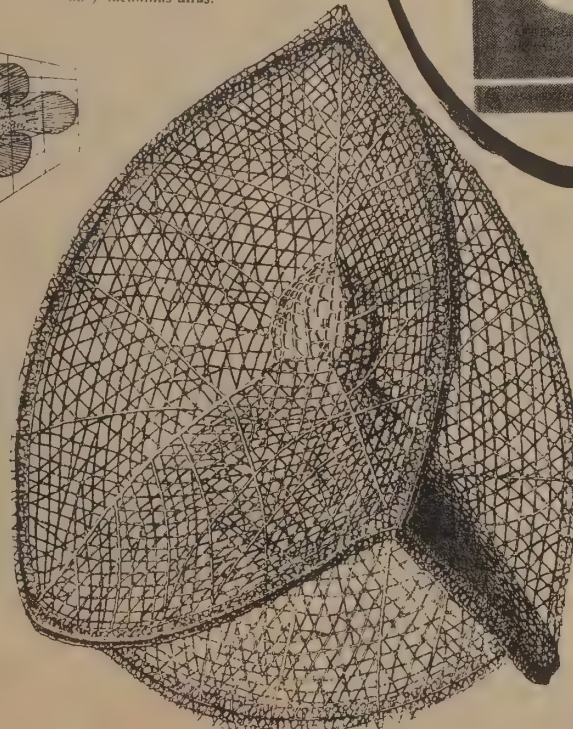
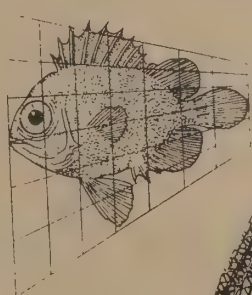

Fig. 62. A Nassellarian skeleton, *Callimntra agnesae* Hkl. (0.1 mm. diameter)

When Plateau made the wire framework of a regular tetrahedron and dipped it in soap-solution, he obtained in an instant a beautifully symmetrical system of six films, meeting three by three in four edges and these four edges running from the corners of the figure to its centre of symmetry. Here they meet, two by two, at the Maraldi angle; and the films meet three by three, to form the re-entrant solid angle which we have called a 'Maraldi pyramid' in our account of the architecture of the honeycomb. The very same configuration is easily recognized in the minute siliceous skeleton of *Callimntra*. There are two discrepancies, neither of which need raise any difficulty. The figure is not rectilinear but a spherical tetrahedron, such as might be formed by the boundary edges of a tetrahedral cluster of four co-equal bubbles; and just as Plateau extended his experiment by blowing a small bubble in the centre of his tetrahedral system, so we have a central bubble also here. This bubble may be of any size; but its situation (if it be present at all) is always the same, and its shape is always such as to give the Maraldi angles at its own four corners. The tension of its own walls, and those of the films by which it is supported or slung, all balance one another. Hence the bubble appears in plane projection as a curvilinear equilateral triangle; and we have only got to convert this plane diagram into the corresponding solid to obtain the spherical tetrahedron we have been seeking to explain (Fig. 63).

The geometry of the little inner tetrahedron is not less simple and elegant. Its six edges and four faces are all equal. The films attaching it to the outer skeleton are all planes. Its faces are spherical,

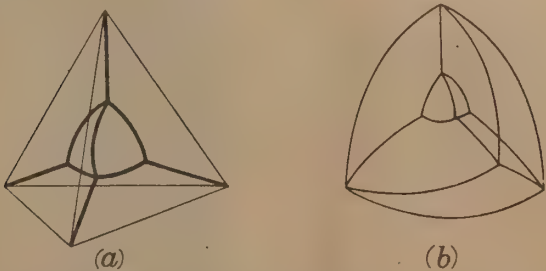

Fig. 63. Diagrammatic construction of *Callimntra*. (a) A bubble suspended within a tetrahedral cage; (b) another bubble within a skeleton of the former bubble.

and each has its centre in the opposite corner. The edges are circular arcs, with cosine  $\frac{1}{3}$ ; each is in a plane perpendicular to the chord of the arc opposite, and each has its centre in the middle of that chord. Along each edge the two intersecting spheres meet each other at an angle of  $120^\circ$ .

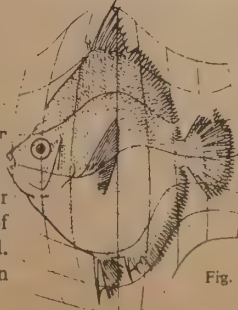
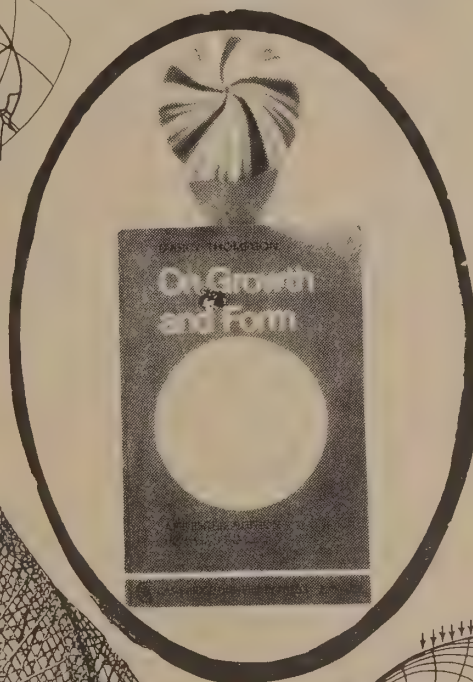

Fig. 153. *Antigonia capros*.

The engineer, who had been busy designing a new and powerful crane, saw in a moment that the arrangement of the bony trabeculae was nothing more nor less than a diagram of the lines of stress, or directions of tension and compression, in the loaded structure: in short, that Nature was strengthening the bone in precisely the manner and direction in which strength was required; and he is said to have cried out, 'That's my crane!'



On Growth and Form

D'Arcy Wentworth Thompson

Two volume edition  
1917, 1952

\$27.50 postpaid

Abridged paper edition  
1917, 1961; 346 pp.

\$2.45 postpaid

Both from:  
Cambridge University Press  
510 North Avenue  
New Rochelle, N.Y. 10801  
or  
WHOLE EARTH CATALOG

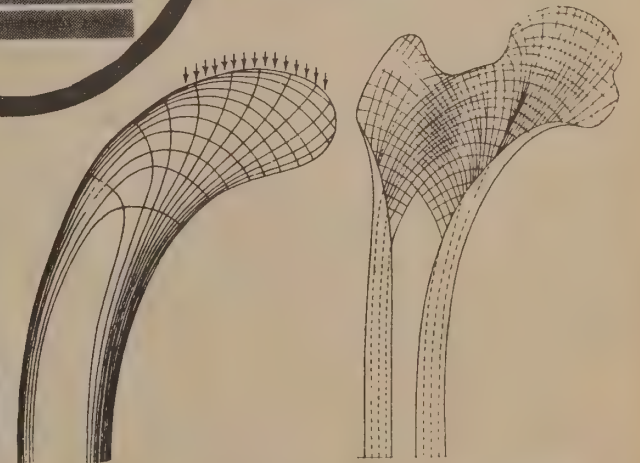
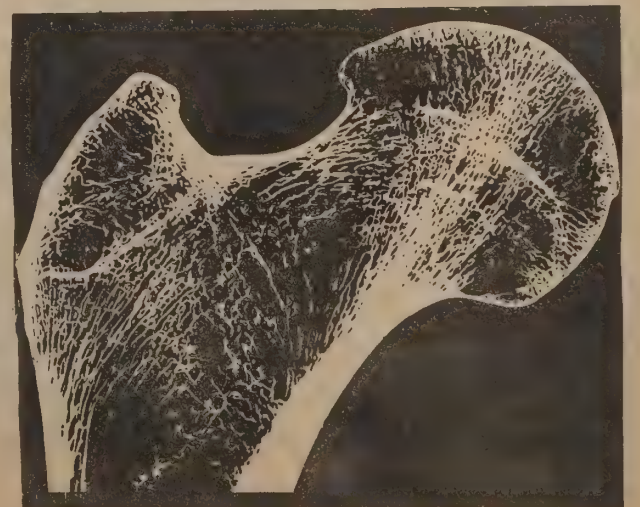

Fig. 101. Crane-head and femur. After Culmann and J. Wolff



# TANTRA ART

EVERY PHENOMENAL OBJECT IS THE CONCENTRATION & REFLECTION OF A CERTAIN PATTERN

IN THIS WAY ART IS A PATH TOWARD TRUTH & REALIZATION OF THE SELF

TANTRA

YANTRA IS AN APPARATUS TO CONNECT ONE OUTSIDE TIME & SPACE IN ETERNITY

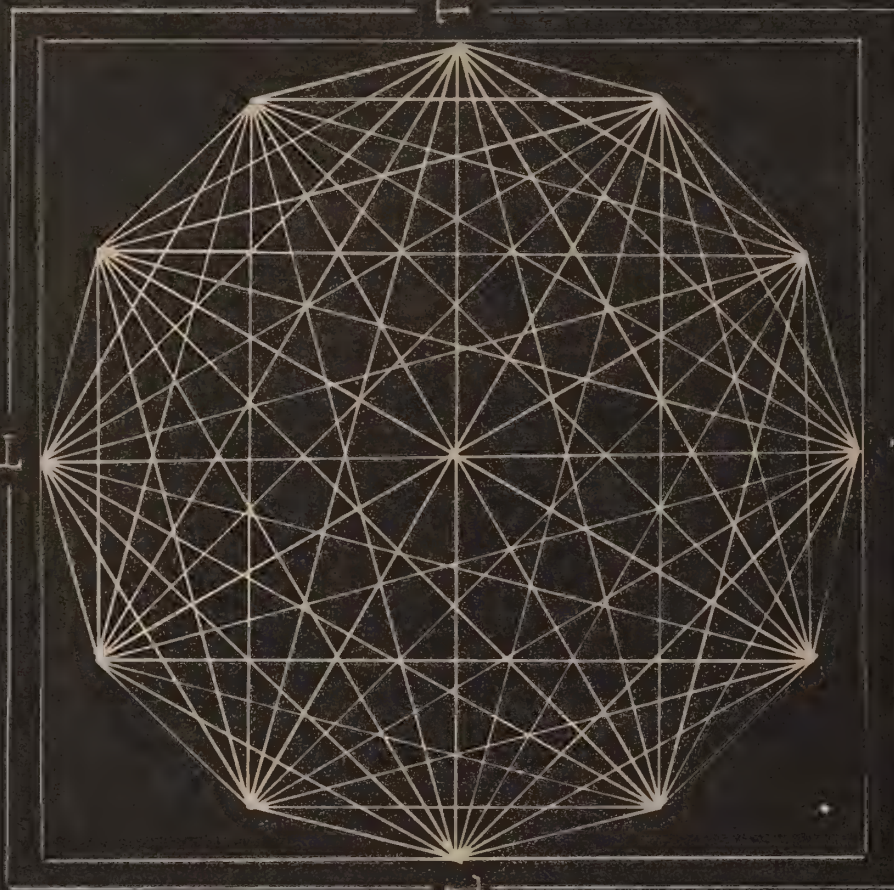

TANTRA

TANTRA

TANTRA

THERE EXISTS NO FORM OF CONCENTRATION MORE ABSOLUTE THAN THE CREATION OF IMAGES

FOR ANY ONE INTERESTED IN YANTRA, MANDALAS, ARCHETYPAL ART, "OBJECTIVE" ART, THIS BOOK IS INVALUABLE. INCREDIBLE COLOR & B & W. REPRODUCTIONS OF WORKS NOT USUALLY AVAILABLE OR ATTAINABLE. THIS BOOK WILL BECOME A STANDARD DICTIONARY FOR "OBJECTIVE" LANGUAGE STUDY. RECOMMEND CONCURRENT READINGS OF TUCCI'S "THEORY & PRACTICE OF THE MANDALA" AS TEXT, WHILE POETIC & INTERESTING, IS NOT PRECISE OR SPECIFIC ENOUGH FOR THOSE DESIRING ALL DE TALES.



[ Suggested by Ann Hogle. Reviewed by Steve Durkee. ]

“What is here, is elsewhere.  
What is not here, is nowhere.”

*Vishvasara Tantra*

Tantra Art

Ajit Mookerjee  
1966; 100 pp.

from: Ravi Kumar  
42, Ave du President Kennedy  
Paris 16<sup>e</sup>, France

\$33.00 postpaid

or: WHOLE EARTH CATALOG

[This is the only art book in the CATALOG]

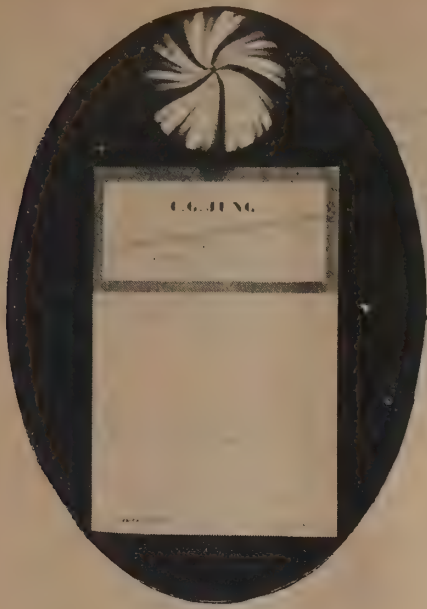

## Psychological Reflections

*Jung in capsules and tasting like medicine.*

*The selection and editing of paragraphs from Jung's writings by Jacobi is done with an informed sense of continuity, so that the book is readable in sequence or by bits.*

*In a world increasingly subjective, everybody is psychologists to one another. Here is one master book of tools.*

### Psychological Reflections

C.G. Jung [ed. Jacobi]  
1945, 1953, 1961: 340 pp.

\$2.25 postpaid

from:  
Harper & Row  
49 East 33<sup>rd</sup> Street  
New York, N.Y. 10016  
or  
WHOLE EARTH CATALOG

The man who would learn the human mind will gain almost nothing from experimental psychology. Far better for him to put away his academic gown, to say good-bye to the study, and to wander with human heart through the world. There, in the horrors of the prison, the asylum, and the hospital, in the drinking-shops, brothels, and gambling hells, in the salons of the elegant, in the exchanges, socialist meetings, churches, religious revivals, and sectarian ecstasies, through love and hate, through the experience of passion in every form in his own body, he would reap richer store of knowledge than text-books a foot thick could give him. Then would he know to doctor the sick with real knowledge of the human soul.

A neurosis has really come to an end when it has overcome the wrongly oriented ego. The neurosis itself is not healed; it heals us. The man is ill, but the illness is an attempt of nature to heal him. We can therefore learn a great deal for the good of our health from the illness itself, and that which appears to the neurotic person as absolutely to be rejected is just the part which contains the true gold which we should otherwise never have found.

The secret of the earth is not a joke and not a paradox. We need only see how in America the skull- and hip-measurements of all European races become Indianized in the second generation. That is the secret of the American soil. And every soil has its secret, of which we carry an unconscious image in our souls: a relationship of spirit to body and of body to earth.

The greater the contrast, the greater is the potential. Great energy only comes from a correspondingly great tension between opposites.

No one develops his personality because someone told him it would be useful or advisable for him to do so. Nature has never yet allowed herself to be imposed upon by well-meaning advice. Only coercion working through casual connections moves nature, and human nature also. Nothing changes itself without need, and human personality least of all. It is immensely conservative, not to say inert. Only the sharpest need is able to rouse it. The development of personality obeys no wish, no command, and no insight, but only need; it wants the motivating coercion of inner or outer necessities. Any other development would be individualism. This is why the accusation of individualism is a cheap insult when it is raised against the natural development of personality.

It is naturally a fundamental error to believe that if we see an anti-value in a value, or an untruth in a truth, the value or the truth is then invalid. They have only become relative. Everything human is relative, because everything depends upon an inner polarity, for everything is a phenomenon of energy. And energy itself necessarily depends on a previous polarity without which there can be no energy. There must always be high and low, hot and cold, etc., so that the process of adjustment which is energy, can occur. The tendency to deny all previous values in favour of their opposites is therefore just as exaggerated as the former one-sidedness. Where generally accepted and undoubted values are suddenly thrown away, there is a fatal loss. Whoever acts in this way ends by throwing himself overboard with the discarded values.

The gigantic catastrophes that threaten us are not elemental happenings of a physical or biological kind, but are psychic events. We are threatened in a fearful way by wars and revolutions that are nothing else than psychic epidemics. At any moment a few million people may be seized by a madness, and then we have another world war or devastating revolution. Instead of being exposed to wild beasts, tumbling rocks, and inundating waters, man is exposed today to the elemental forces of his own psyche. Psychic life is a world-power that exceeds by many times all the powers of the earth. The Enlightenment, which stripped nature and human institutions of gods, overlooked the one god of fear who dwells in the psyche. Fear of God is in place, if anywhere, before the domination power of psychic life.

No doubt it is a great nuisance that mankind is not uniform but compounded of individuals whose psychic structure spreads them over a span of at least ten thousand years. Hence there is absolutely no truth that does not spell salvation to one person and damnation to another. All universalisms get stuck in this terrible dilemma.

## The Human Use of Human Beings

Whole Systems 11

*Norbert Wiener is one of the founders of an n-dimensional inhabited world whose nature we've yet to learn. He is also one of the all-time nice men.*

*A proper sequel to his *Cybernetics* [see p. 32], this book is social, untechnical, ultimate in most of its considerations. Its domain is the whole earth of the mind.*

### The Human Use of Human Beings

Norbert Wiener  
1950, 1954; 288pp

\$1.25

from:  
Avon Books  
250 West 55th Street  
New York, N.Y. 10019

or most book stores

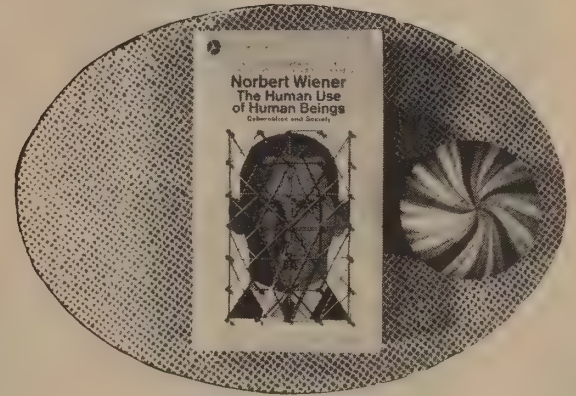

It is the thesis of this book that society can only be understood through a study of the messages and the communication facilities which belong to it; and that in the future development of these messages and communication facilities, messages between man and machine and between machine and machine, are destined to play an ever-increasing part.

Messages are themselves a form of pattern and organization. Indeed, it is possible to treat sets of messages as having an entropy like sets of states of the external world. Just as entropy is a measure of disorganization, the information carried by a set of messages is a measure of organization. In fact, it is possible to interpret the information carried by a message as essentially the negative of its entropy, and the negative logarithm of its probability. That is, the more probable the message, the less information it gives. Clichés, for example, are less illuminating than great poems.

I believe that Ashby's brilliant idea of the unpurposeful random mechanism which seeks for its own purpose through a process of learning is not only one of the great philosophical contributions of the present day, but will lead to highly useful technical developments in the task of automatization. Not only can we build purpose into machines, but in an overwhelming majority of cases a machine designed to avoid certain pitfalls of breakdown will look for purposes which it can fulfill.

We are not stuff that abides, but patterns that perpetuate themselves. A pattern is a message, and may be transmitted as a message.

It is illuminating to know that the sort of phenomenon which is recorded subjectively as emotion may not be merely a useless epiphenomenon of nervous action, but may control some essential stage in learning, and in other similar processes.

It is the great public which is demanding the utmost of secrecy for modern science in all things which may touch its military uses. This demand for secrecy is scarcely more than the wish of a sick civilization not to learn the progress of its own disease.

Koestler's latest book seems to be sharing the fate of Norman O. Brown's *Love's Body*: the book after the big influential one (*Act of Creation, Life Against Death*) is considered too far out, fragmented, excessive... and sells half-heartedly.

Nevermind. Koestler here is doing useful dirty work: saving rat psychology, exploring broader implications of biological systems research, and foreseeing our imminent demise unless we organize our brain-use better. Which brings him to drugs. He proposes research to find a chemical which will voluntarily disengage old-brain from new-brain—the interior emotional kill-heavy unprogrammable stuff from exterior rational flexible stuff. Our paranoia is accidentally designed in, he suggests, and may be designed out. Get to it, outlaws. No nation is going to support this research.

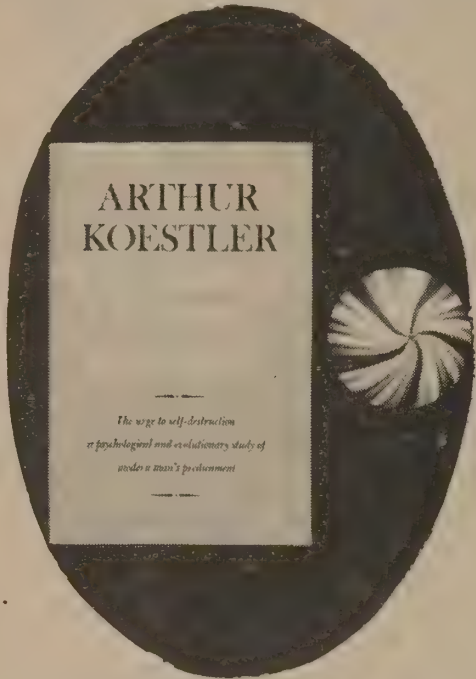

*The Ghost in the Machine*  
Arthur Koestler  
1967; 384 pp.  
\$6.95 postpaid

from:  
Macmillan Company  
Front and Brown Streets  
Riverside, Burlington County  
New Jersey 08075  
or  
WHOLE EARTH CATALOG

The Year 2000

Is Herman Kahn the bad guy (as liberal opinion would have it) or a good guy (as in some informed opinion)? Kahn will hang you on that question and while you're hanging jam information and scalding notions into your ambivalence. He does this best with a live audience, but this book is a fine collection of the information he uses.

Here is most of the now-basic methodology of future study—multi-fold trends, surprise-free projections, scenarios, etc. And here are their results. It's the best future-book of the several that are out.

In my opinion, it is not particularly an accurate picture of the future but the most thorough picture we have of the present—the present statistics, present fantasies, present expectations that we're planning with. We are what we think our future is

If computer capacities were to continue to increase by a factor of ten every two or three years until the end of the century (a factor between a hundred billion and ten quadrillion), then all current concepts about computer limitations will have to be reconsidered. Even if the trend continues for only the next decade or two, the improvements over current computers would be factors of thousands to millions. If we add the likely enormous improvements in input-output devices, programming and problem formulation, and better understanding of the basic phenomena being studied, manipulated, or simulated, these estimates of improvement may be wildly conservative. And even if the rate of change slows down by several factors, there would still be room in the next thirty-three years for an overall improvement of some five to ten orders of magnitude. Therefore, it is necessary to be skeptical of any sweeping but often meaningless or nonrigorous statements such as "a computer is limited by the designer—it cannot create anything he does not put in," or that "a computer cannot be truly creative or original." By the year 2000, computers are likely to match, simulate, or surpass some of man's most "human-like" intellectual abilities, including perhaps some of his aesthetic and creative capacities, in addition to having some new kinds of capabilities that human beings do not have. These computer capacities are not certain; however, it is an open question what inherent limitations computers have. If it turns out that they cannot duplicate or exceed certain characteristically human capabilities, that will be one of the most important discoveries of the twentieth century.

*The Year 2000*  
Herman Kahn and Anthony J. Wiener  
1967; 431 pp.  
\$9.95 postpaid

from:  
The Macmillan Company  
Front and Brown Streets  
Riverside, Burlington County  
New Jersey 08075  
or  
WHOLE EARTH CATALOG

ESCAPE FROM SPECIALIZATION

There is now strong evidence in favour of the theory, proposed by Garstang as far back as 1928, that the chordates—and thus, we, the vertebrates—are descended from the larval stage of some primitive echinoderm, perhaps rather like the sea-urchin or sea cucumber (echinoderm = 'prickly-skinned'). Now an adult sea cucumber would not be a very inspiring ancestor—it is a sluggish creature which looks like an ill-stuffed sausage with leathery skin, lying on the sea bottom. But its free-floating larva is a much more promising proposition: unlike the adult sea cucumber, the larva has bilateral symmetry like a fish; it has a ciliary band—a forerunner of the nervous system—and some other sophisticated features not found in the adult animal. We must assume that the sedentary adult residing on the sea bottom had to rely on mobile larvae to spread the species far and wide in the ocean, as plants scatter their seeds in the wind; that the larvae, which had to fend for themselves, exposed to much stronger selective pressures than the adults, gradually became more fish-like; and that eventually they became sexually mature while still in the free-swimming, larval state—thus giving rise to a new type of animal which never settled on the bottom at all, and altogether eliminated the senile, sedentary cucumber stage from its life history.

This speeding up of sexual maturation relative to the development of the rest of the body—or, to put it differently, the gradual retardation of bodily development beyond the age of sexual maturation—is a familiar evolutionary phenomenon, known as neoteny. Its result is that the animal begins to breed while still displaying larval or juvenile features; and it frequently happens that the fully adult stage is never reached—it is dropped off the life cycle.

This tendency towards a 'prolonged childhood', with the corresponding squeezing out of the final adult stages, amounts to a rejuvenation and de-specialization of the race—an escape from the cul-de-sac in the evolutionary maze. As J.Z. Young wrote, adopting Garstang's views: "The problem which remains is in fact not 'how have vertebrates been formed from sea squirts?', but 'how have vertebrates eliminated the (adult) sea squirt stage from their life history? It is wholly reasonable to consider that this has been accomplished by pedomorphosis.'"

Neoteny in itself is of course not enough to produce these evolutionary bursts of adaptive radiations. The 'rejuvenation' of the race merely provides the opportunity for evolutionary changes to operate on the early, malleable phases of ontogeny: hence pedomorphosis, 'the shaping of the young'. In contrast to it, gerontomorphosis (geras = old age) is the modification of fully adult structures which are highly specialized. This sounds like a rather technical distinction, but it is in fact of vital importance. Gerontomorphosis cannot lead to radical changes and new departures; it can only carry an already specialized evolutionary line one more step further in the same direction—as a rule into the dead end of the maze.

DRAW BACK TO LEAP

It seems that this retracing of steps to escape the dead ends of the maze was repeated at each decisive evolutionary turning point. I have mentioned the evolution of the vertebrates from a larval form of some primitive echinoderm. Insects have in all likelihood emerged from a millipede-like ancestor—not, however, from adult millipedes, whose structure is too specialized, but from its larval forms. The conquest of the dry land was initiated by amphibians whose ancestry goes back to the most primitive type of lung-breathing fish; whereas the apparently more successful later lines of highly specialized gill-breathing fishes all came to a dead end. The same story was repeated at the next major step, the reptiles, who derived from early, primitive amphibians—not from any of the later forms that we know.

And lastly, we come to the most striking case of pedomorphosis, the evolution of our own species. It is now generally recognized that the human adult resembles more the embryo of an ape rather than an adult ape.

Figure 10 is from Garstang's original paper, and is meant to represent the process of evolution by pedomorphosis. Z to Z9 is the progression of zygotes (fertilized eggs) along the evolutionary ladder; A to A9 represents the adult forms resulting from each zygote. Thus the black line from Z4 to A4, for instance, represents ontogeny, the transformation of egg into adult; the dotted line from A to A9 represents phylogeny—the evolution of higher forms. But note that the thin lines of evolutionary progress do not lead directly from, say, A4 to A5—that would be gerontomorphosis, the evolutionary transformation of an adult form. The line of progress branches off from the unfinished, embryonic stage of A4. This represents a kind of evolutionary retreat from the finished product, and a new departure towards the evolutionary novelty Z5 — A5. A4 could be the adult sea cucumber; then the branching-off point on the line A4—Z4 would be its larva; or A8 could be the adult primate ancestor of man, and the branching-off point its embryo—which is so much more like the A9—ourselves.

FIGURE 10

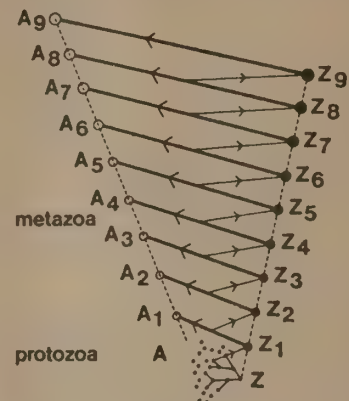

(after Garstang); see text

But Garstang's diagram could also represent a fundamental aspect of the evolution of ideas.

The revolutions in the history of science are successful escapes from blind alleys. The evolution of knowledge is continuous only during those periods of consolidation and elaboration which follow a major break-through. Sooner or later, however, consolidation leads to increasing rigidity, orthodoxy, and so into the dead end of overspecialization—to the koala bear. Eventually there is a crisis and a new 'break-through' out of the blind alley—followed by another period of consolidation, a new orthodoxy and so the cycle starts again.

But the theoretical structure which emerges from the break-through is not built on top of the previous edifice; it branches out from the point where progress has gone wrong. The great revolutionary turns in the evolution of ideas have a decidedly pedomorphic character. Each zygote in the diagram would represent a seminal idea, the seed out of which a new theory develops until it reaches its adult, fully matured stage. One might call this the ontogeny of a theory. The history of science is a series of such ontogenies. True novelties are not derived directly from a previous adult theory, but from a new seminal idea—not from the sedentary sea urchin but from its mobile larva. Only in the quiet periods of consolidation do we find gerontomorphosis—small improvements added to a fully grown, established theory.

At first sight the analogy may appear far-fetched; I shall try to show that it has a solid factual basis. Biological evolution is to a large extent a history of escapes from the blind alleys of overspecialization, the evolution of ideas a series of escapes from the bondage of mental habit; and the escape mechanism in both cases is based on the principle of undoing and re-doing, the draw-back-to-leap pattern.

The Futurist

In part because the Future is a new field of methodic study this is a lively newsletter. It reports bi-monthly on new books, books and programs having anything to do with social forecasting. Future study is like education: everybody thinks they're good at it. The newsletter has some of that diluted flavor, but it doesn't matter. Useful pointing at useful activities done here.

from:  
World Future Society  
P.O. Box 19285  
20th Street Station  
Washington, D.C. 20036  
*The Futurist*  
\$5 for one year

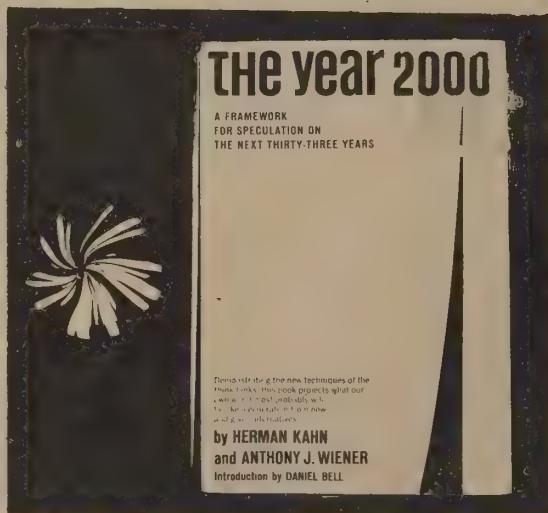
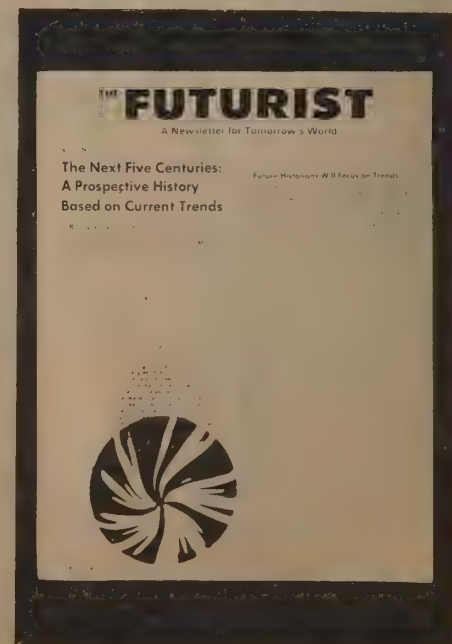

TABLE IX  
*The Postindustrial (or Post-Mass Consumption) Society*

1. Per capita income about fifty times the preindustrial
2. Most "economic" activities are tertiary and quaternary (service-oriented), rather than primary or secondary (production-oriented)
3. Business firms no longer the major source of innovation
4. There may be more "conservatives" (vs. "marketives")
5. Effective floor on income and welfare
6. Efficiency no longer primary
7. Market plays diminished role compared to public sector and "social accounts"
8. Widespread "cybernation"
9. "Small world"
10. Typical "doubling time" between three and thirty years
11. Learning society
12. Rapid improvement in educational institutions and techniques
13. Erosion (in middle class) of work-oriented, achievement-oriented, advancement-oriented values
14. Erosion of "national interest" values
15. Sensate, secular, humanist, perhaps self-indulgent criteria become central



**The Dymaxion World of Buckminster Fuller**

The most graphic of Fuller's books (it's about his work, by Robert Marks). Consequently it is the most directly useful if you are picking up on specific projects of his such as domes, geometry, cars, demographic maps and charts, etc.

**The Dymaxion World of Buckminster Fuller**

Robert W. Marks from: Southern Illinois University Press  
 1960; 232 pp. 600 West Grand  
**\$10.00** postpaid Carbondale, Illinois 62903

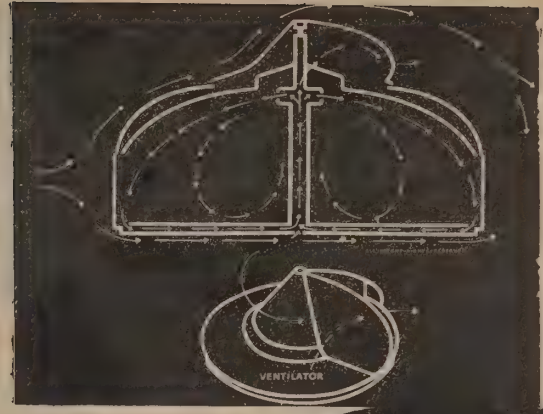
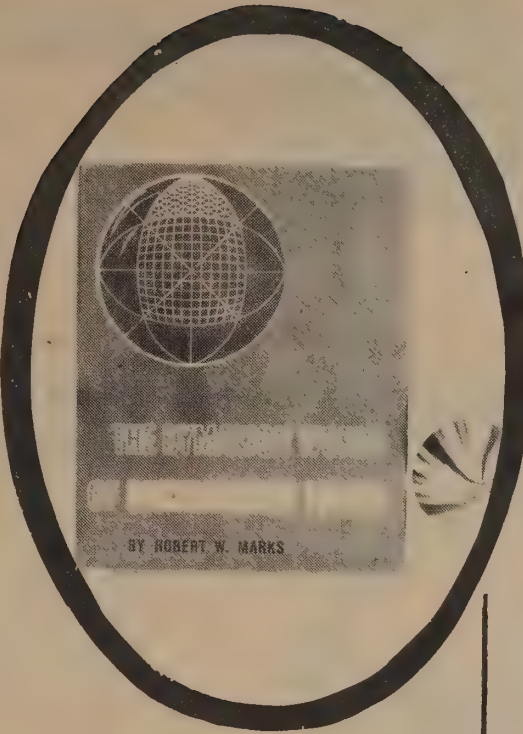
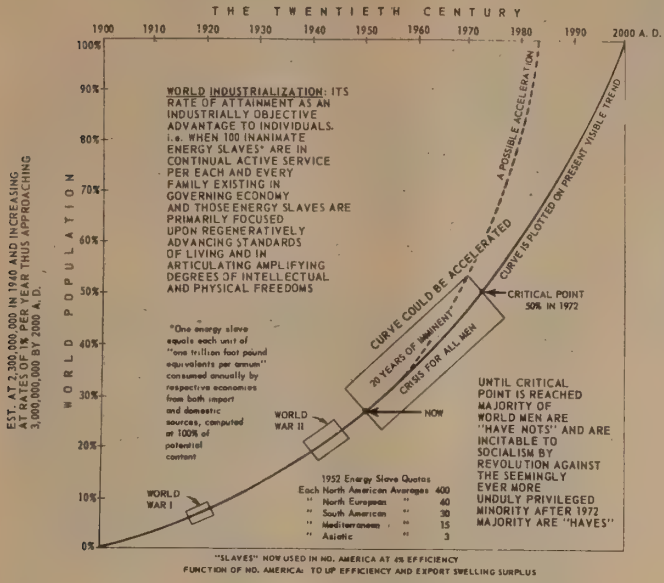

Shelter & Land 13

**Fuller Sun Dome**

The most readily available plans for a geodesic dome are these. The \$5 cost includes construction license. Built of wood strips and cheap polyethylene skin, the dome can be built up to 30 feet diameter. For more elaborate plans you should correspond with Fuller's office, Box 909, Carbondale, Illinois.

[Suggested by Ken Babbs]

**Geodesic Sun Dome**  
 1966  
**\$5.00** postpaid

from: Sun Dome  
 Popular Science Monthly  
 355 Lexington Avenue  
 New York, N.Y. 10017

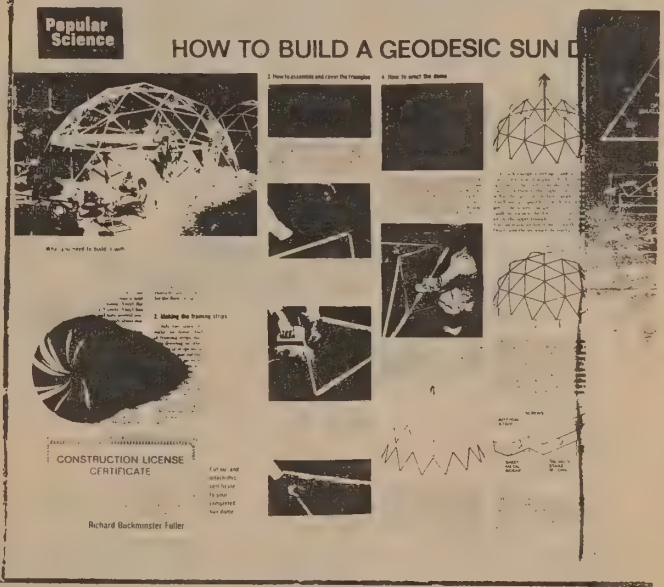
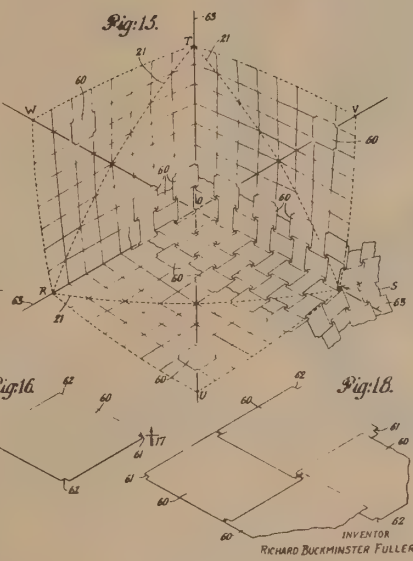
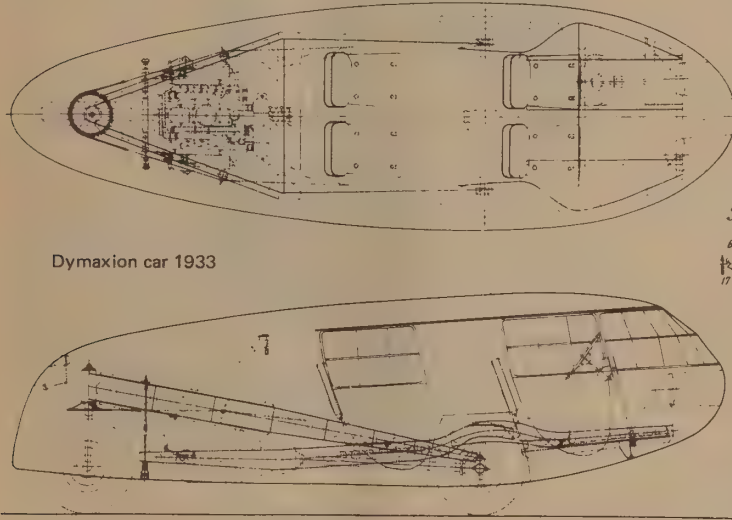

**Space Structures**

This is a big fat reference book on domes, trusses, cable nets, forms that will keep the rain out in a big way, or elegantly hold water or electric lines up in the air. The book resulted from the International Conference on Space Structures held in London in 1966. It's said to be the first comprehensive book book of its kind. Very heavy book; it'll either help you or discourage you, depending on how far into construction you are.

We could use an informed review on this one. If we don't get it we'll drop the book.

**Space Structures**  
 R.M. Davies, ed.  
 1967; 1233 pp.

**\$46.50** postpaid

from: John Wiley & Sons, Inc.  
 605 Third Ave.  
 New York, N.Y. 10016  
 or John Wiley & Sons, Inc.  
 Western Distribution Center  
 1530 South Redwood Road  
 Salt Lake City, Utah 84104

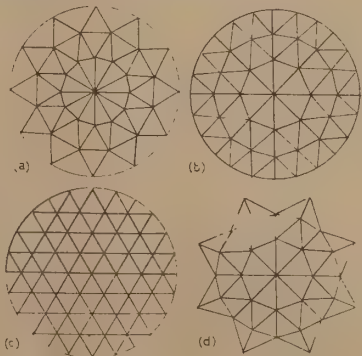
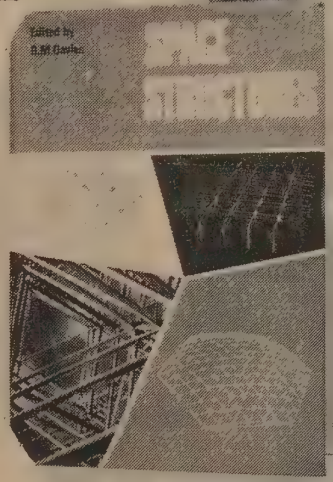

Figure 1. (a) to (d)



F. CASTAÑO

frames.

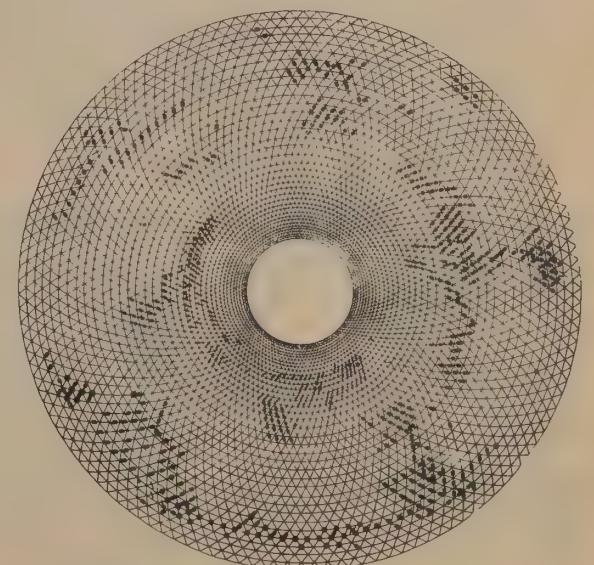
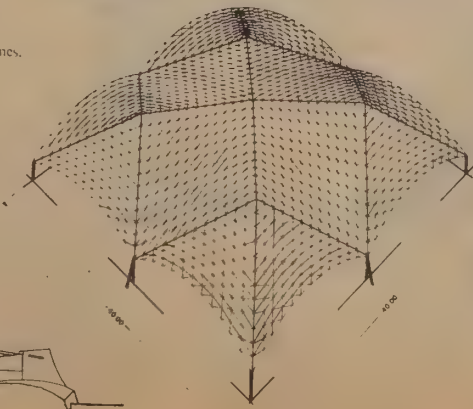

Figure 6. Positions of the deformed bars and displaced nodes and joints.

from: "Failure of a Dome of Great Span"

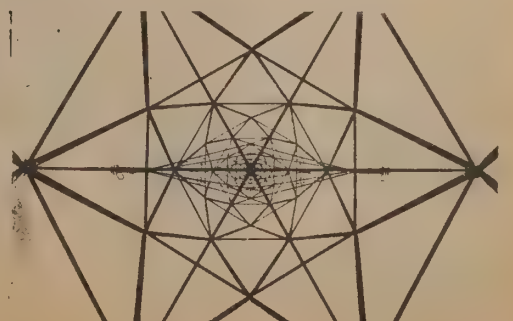

Figure 9 (c). View looking upwards from the centre of the tower.

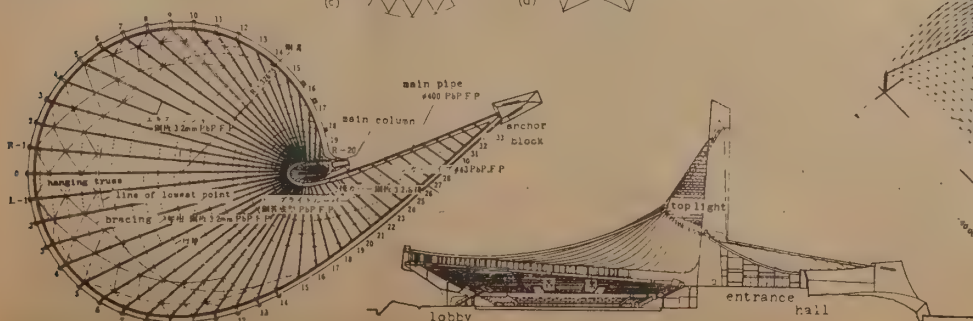

Figure 2. Roof plan and section.

The only pavillon of Expo 67 more beautiful than Fuller's U.S. Dome was the West German tent, designed by Frei Otto. He is currently the master of structures whose flexible skin is the prime structural element. Volume One of his 2-Volume work is devoted to Pneumatic Structures—air houses plus. Every designer we know who's seen this book has commended to giggle and point, jump up and down, and launch into enthusiastic endorsement of Otto, design, being a designer, and look at this here.

14

Shelter  
E-Land

The book is comprehensive in its field, technically thorough, beautifully presented. Volume Two of *Tensile Structures*, shortly available for \$18.50 from MIT is presumably equally good.

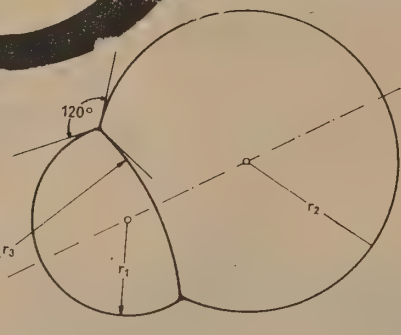
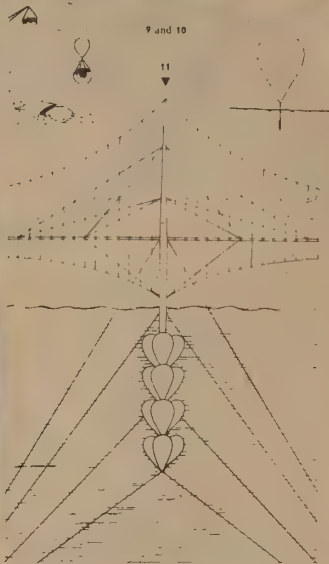
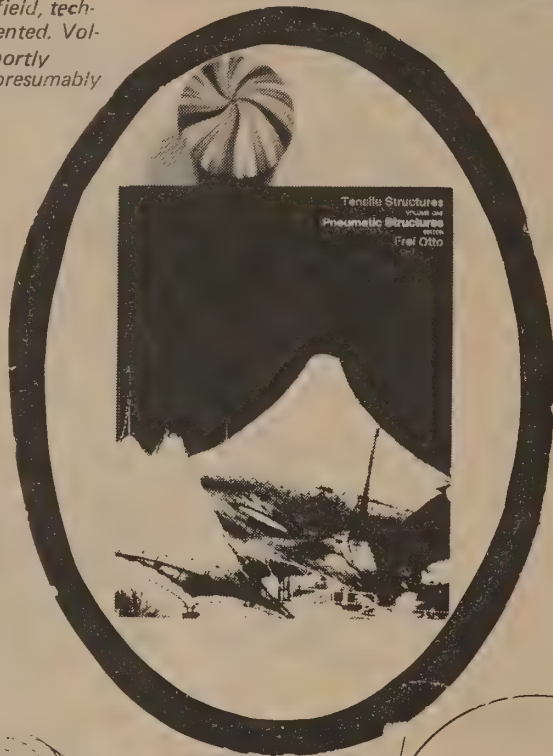
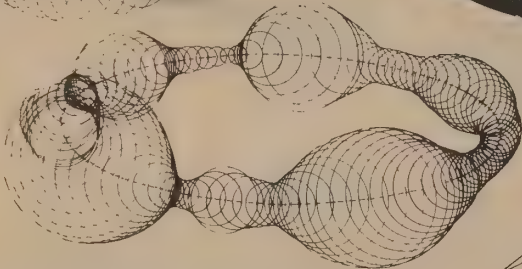
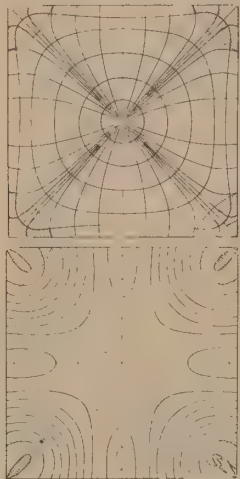
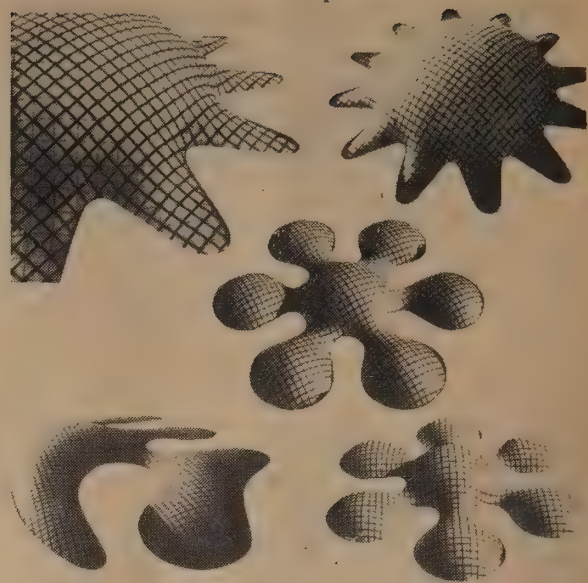

The saddle surface of the inside part has a smaller area than the outside, which is not a saddle surface. The torus differs from all other pneumatically tensed membranes by this characteristically saddle-shaped region. The circle on which the spheres forming the torus are strung need not be in the same plane, nor need the spheres have equal diameter. Here, too, unlimited variations are possible, subject to the general laws of formation, and to those particular to closed hoses.

If two soap bubbles of different diameters form a twin bubble (Fig. 10), the diaphragm is curved. If the membrane stresses are equal, the gas pressure  $p$  in the smaller bubble is higher than that in the larger bubble. The relationship between the radii  $r_1, r_2, r_3$  is given by:

$$n = \frac{p_1 r_1}{2} = \frac{p_2 r_2}{2} = \frac{(p_1 - p_2) r_3}{2}$$

*Tensile Structures* Volume One  
Pneumatic Structures

Frei Otto  
1957; 320 pp,  
1660 illustrations

\$22.50 postpaid

from:  
The MIT Press  
Cambridge, Mass 02142  
or  
WHOLE EARTH CATALOG

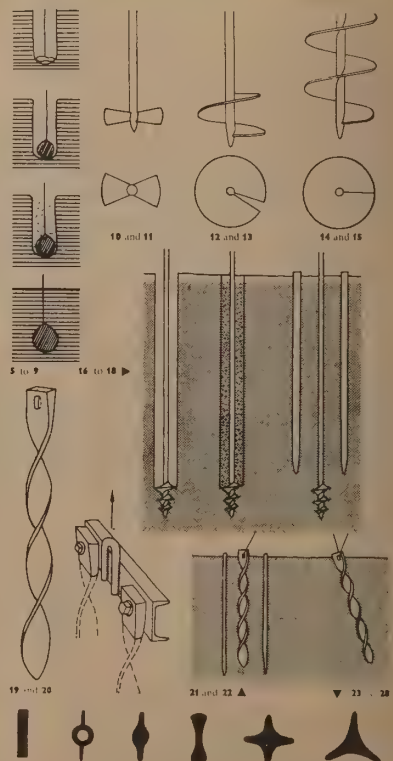
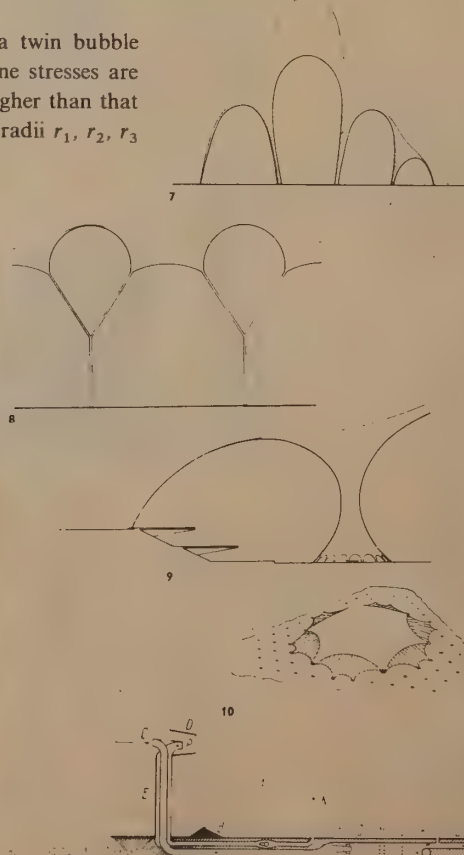
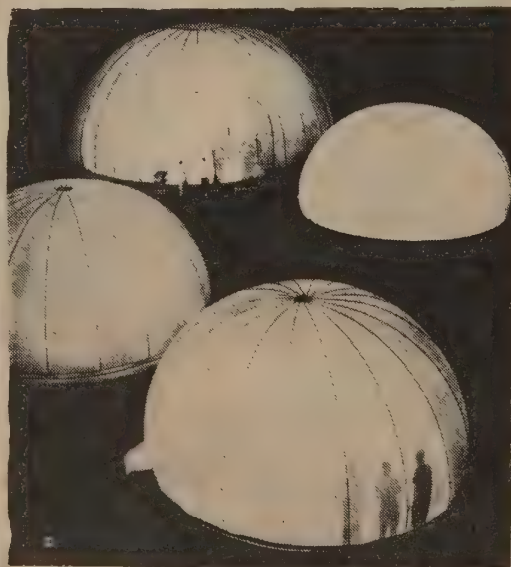
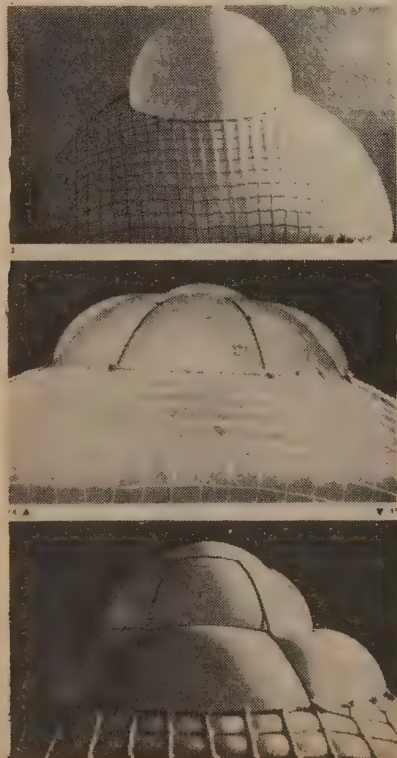

- A Membrane of heavy fabric or wire with transparent plastic coating.
- B Annular foundation.
- C Air inlet in air-conditioning tower having rotatable cap.
- D Guide-vane annulus to adjust position of cap.
- E Heat exchange in air-conditioning tower. In winter the used air heats the fresh air in a counter-flow arrangement.
- F Blower.
- G Air baffles.
- H Heating and cooling plant.
- I Humidifier.
- K Ring main.
- L Underground distribution line, serves also to heat ground.
- M Warm air discharge.
- N Used air extraction.
- O Pressure regulation valve.
- P Exhaust discharge.
- Q Air lock accessible to trucks.



**Dome Cookbook**

Drop City, Colorado, a rural vacant lot full of elegant funky domes and ditto people, has been well photographed and poorly reported in national magazines. Visitors and readers simply assumed that the domes were geodesic Fuller domes, which some indeed are. But most of them were designed by another guy who designs to another geometry: Steve Baer.

This tabloid contains the crystallographic theory and junkyard practice behind Baer's domes: from how to distort a polyhedron without affecting connector angles to how to chop the top out of a car without losing your foot. From all we can determine, Baer's theory is unique in architecture. So is his practice; instead of dying of dissertation dry rot, his notions stand around in the world bugging the citizens.

The *Dome Cookbook* is published by Lama Foundation, an intentional community in New Mexico, built largely of Baer domes.

Very reasonable price.

*Dome Cookbook* from: Lama Foundation Box 444 San Cristobal, New Mexico 87564  
Steve Baer 1968; 40 pp.  
\$1.00 postpaid

model - how arm-  
duke of semi res

Cosider -  
Macmilla  
has exc  
good ill  
a diffi  
A.O. Al  
Polyeder  
Berlin  
complete  
great R  
Not yet  
English

Are we working at a new society- load sharing intelligently put together, one that will someday reveal the load bearing pillars of today's arrangement as totally unnecessary.

Will these pillars of society as they feel the structure trembling to lift up and away attach themselves hoping to hold it down, hoping to keep the status quo. Will that be a joke- something pretending to carry while being carried/?

panel had  
ce by some  
ad created  
as we put  
t got down  
ere was one  
y bowed,  
The entire  
began for  
ide out  
ook at them"  
it was-  
its shape,  
was heavy  
they were  
; they had been  
tops,  
ree important  
in one moment  
slow swinging

How - Architectural Design

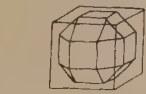

Here is an exploded cube inside a large cube showing that exploding a small figure or cutting away the edges and corners of a large figure can produce the same thing.



a rhombic dodecahedron and an exploded rhombic dodecahedron. In this case it has been exploded just as far as the edge lengths of the diamonds.

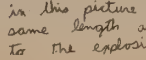

In this picture all the zones are the same length and they are also equal to the explosion  $a=b=c=d=e$



fused cluster of exploded rhombic dodecahedra. The zones have been stretched different lengths and the entire cluster is cut by the plane of the floor these are zones

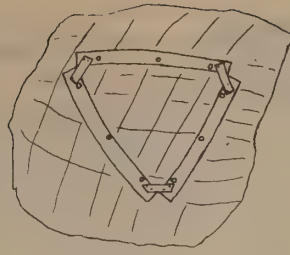

flexible plywood pattern on car top

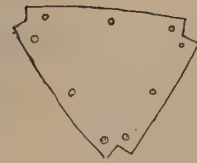

panel cut and drilled

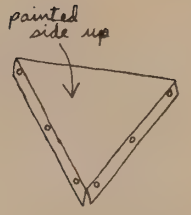

panel, cut, drilled and broken

This is a wonderful quality of space, we can eat it up in different sizes and shapes in infinite numbers of ways.

If we adopt a family of angle regular or merely angle similar polygons to be used as floor plans of rooms, city blocks, etc. one further property we will almost certainly want is that the figures don't, as we place them side by side, have gaps appear, dead spaces which we can not occupy with any of our figures. It is likely that our plan will not be a dense packing, we ourselves will make gaps between the polygons, but we don't want their position imposed upon us!

Shelter 15 & Land

this is a cube and an exploded cube you can see that rectangles appear over the edges and triangle over the corners

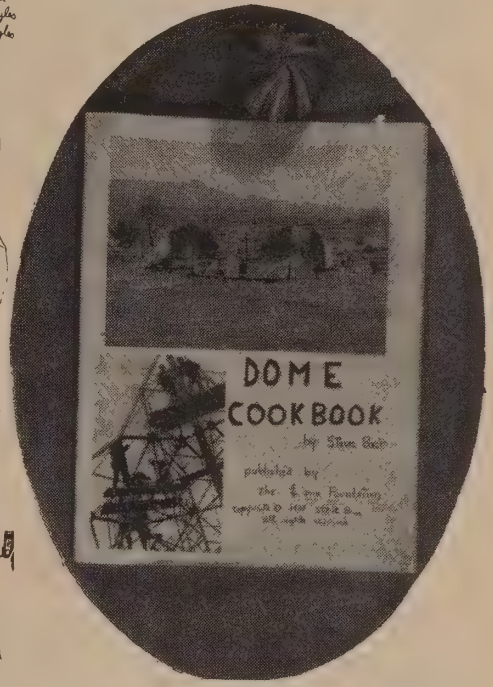
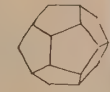

**Good News**

How many people do you know who got their grant? Edwin Schlossberg got his—from Rockefeller Brothers to put out a broadside of good news, six times a year, free of charge.

Schlossberg's appreciation of what is news and what is good is demonstrated by the contents of the current issue:

- 'The Future as a Way of Life' Alvin Toffler
- 'Education for Real' John McHale
- 'The Prospect for Humanity' R. Buckminster Fuller
- 'Diary: How to Improve the World (You Will Only Make Matters Worse)' John Cage
- 'Information Explosion — Knowledge Implosion' John McHale
- 'Logical Structure of Environment and Its Internal Representation' Heinz von Foerster

[Why is this item not in Whole Systems? Partly oversight—partly that it's kindred to Baer.]

Good News from: Edwin Schlossberg 128 West 13th Street New York, N.Y. 10011  
Free six issues this year

A highly sophisticated configuration is shown in Fig. 2c which presents the results of the first 200,000 steps of the motion of four spots each of which has the same constraints as our spots before, with the additional constraint that they all interact weakly with each other in the sense that they "repel" each other when they come too close (the transition probability for turning away from each other is slightly increased when near), and that they "attract" each other when they go too far (the transition probability for turning toward each other is increased when apart). Clockwise circumnavigated squares are painted black. Since there are only 256 steps visible in this pattern, it is clear that some of the steps must have been repeated several thousand times. Hence, this pattern has reasonable stability.

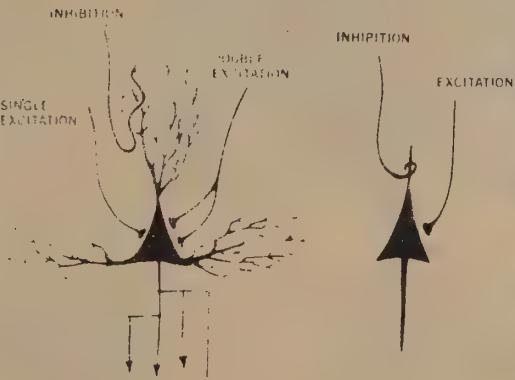

It is not difficult to show that, with these types of connections, symbolized on an "idealized" neuron in Fig. 4b (namely excitation [yes], inhibition [no], or excitation [true], inhibition [false]) a single neuron is in a position to compute various "logical functions", and small nets of only three neurons are capable of computing all logical functions of the form "A and B", "A or B", "if A so B", "A equivalent B", "A or not B", etc. where A and B are two active afferent axons.

A student of this structure, who does not know how it is created, will come to the conclusion that this "molecule" is built of two kinds of "atoms", one black (+) and one white (-), with shapes as suggested in Fig. 2d, which obey a law of nature that forces them to bind into higher structures such that opposite signs attract. We may smile at the naivete of this natural scientist who discovers these "laws", because we know that this whole pattern is generated by only four spots zooming around like mad in an almost random fashion. However, we should not forget that the accent lies on the almost. That is the crux of my thesis: Small constraints are sufficient to produce considerably ordered structures. Hence, the discoveries of our natural scientist are not so naive after all; he only puts his knowledge into a different language. The two descriptions are equivalent.

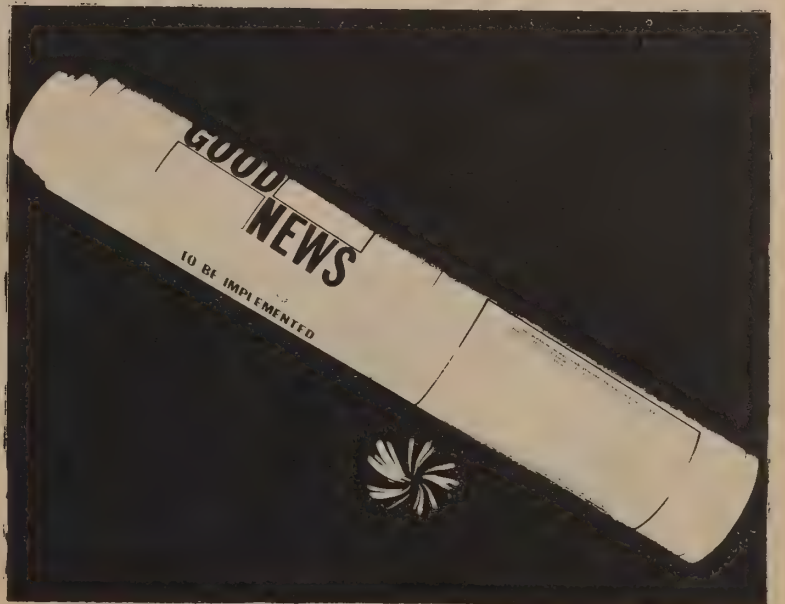

Heinz von Foerster

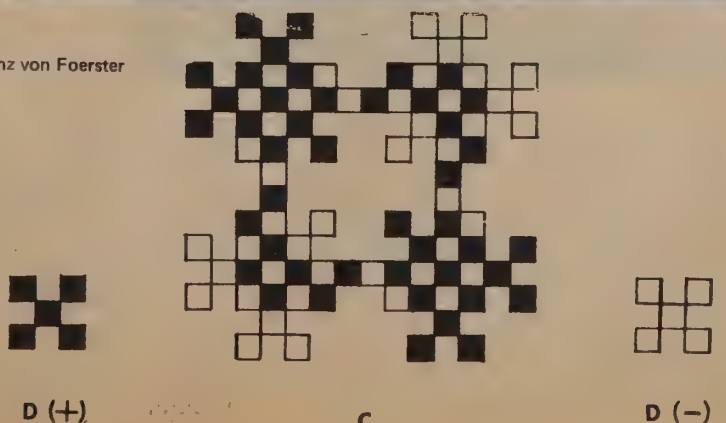

## Architectural Design

This is the only architectural magazine we've seen that consistently carries substantial new information, as distinct from the stylistic eye-wash characteristic of most architecture journals. It galls my jingoistic soul to see the British publishing so much of the best technological information (cf. *New Scientist*, p.24; *Industrial Design*, p.25; *Sculptor's Manual*, p.30; *TV Production*, p.39). Dave Evans, a local Australian whiz, says it's because English bright guys don't have much to grip them commercially, so they spread their brightness around. (Also they flock to America in search of commercial ferocity.)

Anyway, here's to more fluid information.

### Architectural Design

**\$13.50** postpaid for one year (monthly) from:  
Architectural Design  
26 Bloomsbury Way  
London WC 1, England

Triggered by a lack of space, and wanting to do something, a group of architectural students at MIT last year spontaneously rebelled against the constraining environment of their drafting rooms. Scrounging materials, working clandestinely, they shifted block partitions and erected a series of mezzanines or platforms within their two-storey drafting rooms (centre). Three architecture students, Stern, Hanks and Owen, describe below the process as they saw it.

The design faculty, also cramped for space, solved their own problems more conventionally, through outside designers and contractors. This failed to generate a corresponding level of excitement, commitment or sense of achievement.

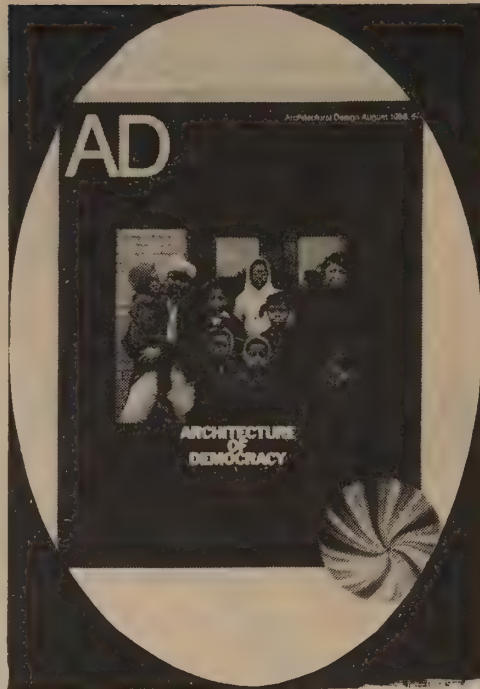

### Capsulized freak out

Metal to rubber of asphalt ribbons plugged into Vietnam and the price of aerosolled ketchup thru W.D.B.J. Star City via the chromium telescoping finger. 700 miles of the great highway turn on, 13 hours of keen-sell survival service and all the gear to keep the wheels flying, the gut full, and the mind blown on soul and acid, and tune-in, eat, and flash, rush, One South and zapp it forward, gas-up; and hum and sink into supa-fit vinyl pads and watch it all. All the cardboard cities and the X-ray of us all on the giant billboards. And buy me, lay me hot dog-burgers. Blink, zip me into bed and flash past a thousand Kleenex sleeperies and King-size pleas trying to break up the big high and consume hy-flyte, Pep-up, an alligator breakfast a nude-serviced eat.

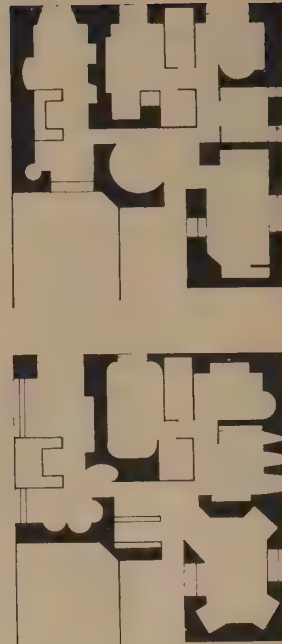

## Topic

To make each house so personal, individual and well-adapted to its inhabitants, that 100,000 houses will be as different from one another as 100,000 people are.

## Author

Christopher Alexander, June 1967.

## Pattern

IF: there is given any dwelling—apartment or house, irrespective of the number of inhabitants. (This pattern may also apply to certain other buildings like offices which require an individual and personal character.)

THEN: every wall, (both interior and exterior) is to be 3-5ft deep, and made of hand-carvable-space-frame. Floors are to be 2-3ft deep, and also made of hand-carvable-space-frame.

### Definition:

Hand-carvable-space-frame is to be interpreted as follows. It is a rigid space frame, with an exterior vertical surface made of materials which are readily available on the retail market, and easily cut, modified, painted, nailed, glued, replaced by hand, using only tools available at any hardware store. Possible examples are wood, plywood, fibreglass, styrofoam, polystyrene. . . . The space frame is to be made highly redundant, so that large sections of it may be removed without weakening it. It is also made so that pieces or sections may be added to it in such a way that these sections become continuous with, and indistinguishable from, the original surface.

## The Japanese House

Without getting all sentimental and exotic we're still going to agree that Japanese make better houses than anybody else (they also have the fastest growing economy in the world, but that's another story — or is it?). If you're going to build your own house and don't mind some inspiration on the subject, this book was laboriously made for you. It's a great big Christmas present of a book full of yummy photos and diagrams and details of technique, all of which seems right within reach: I-can-do-it. Nice cure for nothing-can-be-done-because-it's-too-damned-big industrial blues.

[Suggested by Tassajara Zen Center]

\$27.50 may choke you up in which case try *Japanese Homes and Their Surroundings*, \$2.50 from Dover Publications, Inc., 180 Varick Street, New York, N.Y. 10014.

SECLUSION IN BUILDING is an essential instrument for establishing, or preserving, the freedom of man. For, only in solitude can man escape from the coercion to which he is subjected when among the masses.

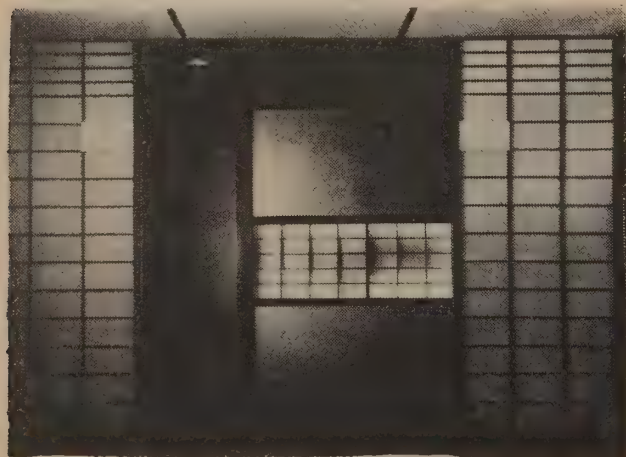
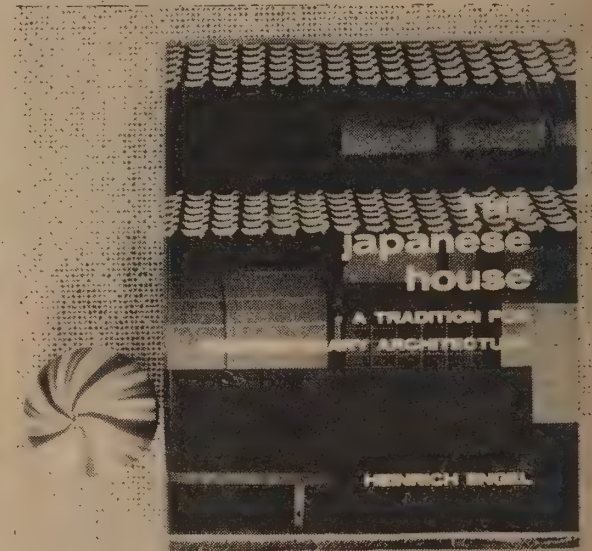
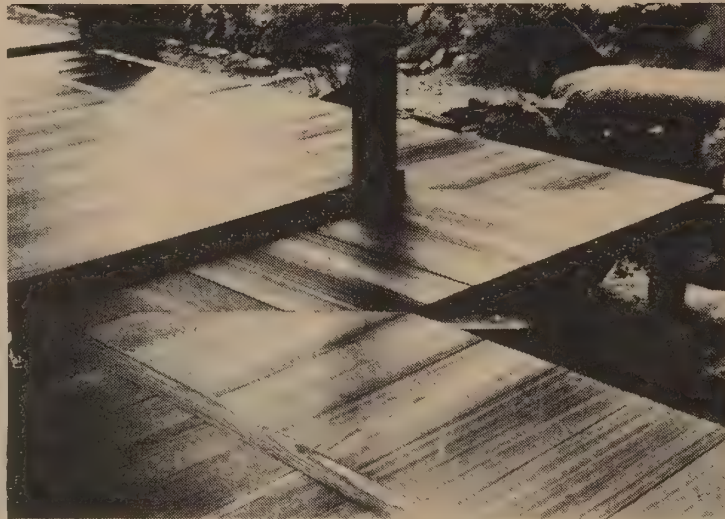

Shōji paper is the "glass" of the Japanese house. Its qualities, however, are of a different nature, and, thus, also are its effects. The light, broken already by the broad overhang of the eaves, is diffused by the paper and creates a characteristic light condition comparable to twilight. This situation does not change basically even if the evening or winter sun hits the paper directly. No glare, no shadows; a general gloom creates a soft, emotional atmosphere. With artificial light in use, the shōji paper shows its reflective-diffusing ability, and at night with lights turned out, might even offer an interesting shadow play the moon has staged with the old weather-worn pine tree. As time passes, the paper darkens. Here and there, a torn piece is carefully cut out and replaced by new, lighter paper. The paper pattern becomes, though irregular, more interesting and lively. The paper ages, as does man.

### The Japanese House — A Tradition for Contemporary Architecture

Heinrich Engel  
1964; 495 pp.

\$27.50 postpaid

from:  
Charles E. Tuttle Co., Inc.  
Rutland, Vermont 05701  
or  
WHOLE EARTH CATALOG

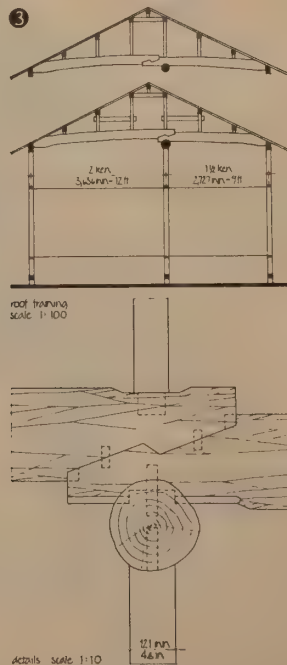

Dimensioning of roof post 'koyasaka' according to 'kusan' insulate.

width = breadth - 0.2 x column size

Once the room requirement is decided, the separate rooms are sometimes cut out in paper and children and parents individually try to achieve the best room arrangement on the ken grid. One mat arrangement is finally decided upon and wall openings, picture recesses (tokonoma), closets, etc., are listed. No measurements are given. Everything is controlled merely by the ken grid and the mat arrangement.

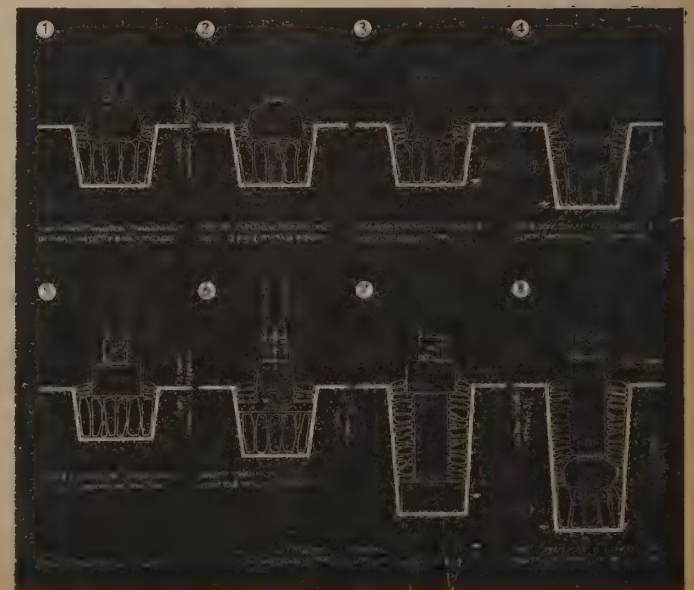

## Audel Guides

We've seen no series of individual technique publications more complete than the Audel books published by Howard Sams and Company. However, we're not proficient enough in this area to critique particular manuals against others in their field. Suggestions and reviews invited.

This part of the WHOLE EARTH CATALOG should be one of the most thorough. How-to books are notoriously unreviewed.



All of the following prices are postpaid.

- Automobile Guide (AUD-1) \$6.95
- Home Appliance Service Guide (AUD-2) \$6.95
- Radiomans Guide (AUD-3A) \$5
- Television Service Manual (AUD-3B) \$5
- Handy Book of Practical Electricity (AUD-4) \$5.95
- Truck and Tractor Guide (AUD-5) \$5.95
- Plumbers & Steam Fitters Guides - 4 Vols. (AUD-6)
- Painting & Decorating Manual (AUD-7) \$4.95
- Carpenters and Builders Guides - 4 Vols. (AUD-8) set \$16.95
- Diesel Engine Manual (AUD-9) \$6
- Welders Guide (AUD-10) \$4.95
- Mathematics and Calculations for Mechanics (AUD-11) \$4.95
- Machinists Library (AUD-12) \$13.50 set
- Wiring Diagrams for Light and Power (AUD-13) \$4
- Home Refrigeration & Air Conditioning Guide (AUD-14A) \$6.95
- New Electric Library 10 Vols. (AUD-15A) set \$25
- Answers on Blueprint Reading (AUD-25) \$4.95
- Masons & Builders Guides - 4 Vols. (AUD-26) set \$10.50
- Electric Motor Guide (AUD-27) \$5.95
- Oil Burner Guide (AUD-28) \$3.95
- Sheet Metal Pattern Layouts (AUD-29) \$7.50
- Sheet Metal Workers Handy Book (AUD-30) \$3.95
- Mechanical Drawing Guide (AUD-31) \$3
- Mechanical Drawing and Design (AUD-32) \$3.95
- Questions & Answers for Electricians Exams (AUD-34) \$3.50
- Electrical Power Calculations (AUD-35) \$3.95
- New Electric Science Dictionary (AUD-36) \$3.50

## Alaskan mill

We've heard almost nothing about how good this 'one-man sawmill' is, but we've heard plenty of statements of need for such an item. If you get one before we do, let us know about it.

The ALASKAN JR. is a lightweight, one-man lumbermaker. Drill 3 holes in the blade and simply mount on your own chain saw. It is easy to operate, and mills accurate smooth, full dimension grade one lumber—wherever you need it, even in remote areas.

**SIMPLY MOUNT THIS ATTACHMENT TO YOUR CHAINSAW MOTOR.** . . . . . no special tools or alterations are required. It's as simple as changing bar and chain. Use with one or two motors, either direct or gear drive with 6 or more horsepower. With this attachment you can make all the lumber you need. All perfectly dimensioned beams, railroad ties, cabin logs, hardwood cants, etc. The Alaskan is available in 6 models.

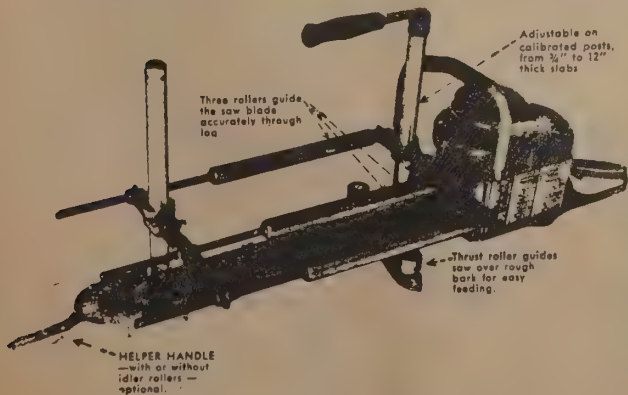

Alaskan, Jr., for blades 16"-24" 20 lbs. \$57.00

postpaid for complete unit: Alaskan, Jr., bar and chain, helper handle, oiler kit, guide rail brackets, file and guide, and 7 hp Mono power unit. \$333.58

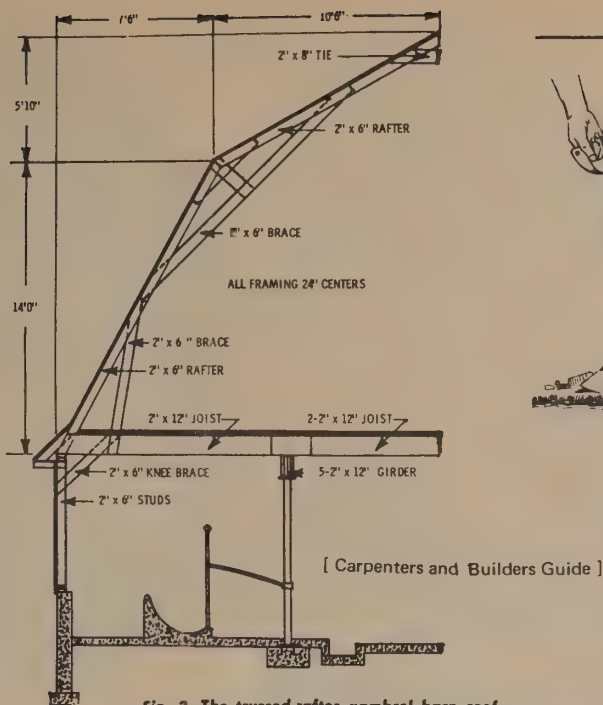

Fig. 3. The trussed-rafter gambrel barn roof.

- Power Plant Engineers Guide (AUD-37) \$6.95
- Questions & Answers for Engineers & Firemans Exams (AUD-38) \$4
- Pumps, Hydraulics, Air Compressors (AUD-40) \$6.95
- House Heating Guide (AUD-41) \$5.95
- Milwrights & Mechanics Guide (AUD-42) \$6.95
- Do-It-Yourself Encyclopedia 2 Vols. (AUD-43) \$8.95
- Water Supply & Sewage Disposal Guide (AUD-46) \$4
- Gas Engine Manual (AUD-48) \$4
- Outboard Motor & Boating Guide (AUD-49) \$4
- Encyclopedia of Space Science - 4 Vols. (AUD-50) set \$19.95
- Domestic Compact Auto Repair Manual (AUD-52) \$5.95
- Foreign Auto Repair Manual (AUD-53) \$5
- Programmed Basic Electricity Course (AUD-54) \$4
- Home Workshop & Tool Handy Book (AUD-55) \$5
- Home Modernizing & Repair Guide (AUD-56) \$2.95
- Practical Chemistry for Everyone (AUD-57) \$5.95
- Home Gas Heating and Appliance Manual (AUD-59) \$3.50
- Practical Guide to Mechanics (AUD-61) \$4
- Practical Mathematics for Everyone - 2 Vols. (AUD-66) set \$8.95
- Architects and Builders Guide (AUD-69) \$4
- Handbook of Commercial Sound Installations (AUD-92) \$5.95
- Practical Guide to Tape Recorders (AUD-93) \$4.95
- Practical Guide to Auto Radio Repair (AUD-94) \$4.50
- Practical Guide to Citizens Band Radio (AUD-95) \$4.95
- Practical Electronics Projects for the Beginner (AUD-96) \$4.95
- Practical Guide to Servicing Electric Organs (AUD-97) \$4.95
- Practical Guide to Building Maintenance (AUD-99) \$4.95
- Practical Guide to Fluid Power (AUD-100) \$6.95
- Practical Science Projects in Electricity/Electronics (AUD-102) \$4.95

Alaskan mill

from: Kiser Enterprises, Alaskan Div. P.O. Box 827 Hopewell, Virginia 23860

## Foundations

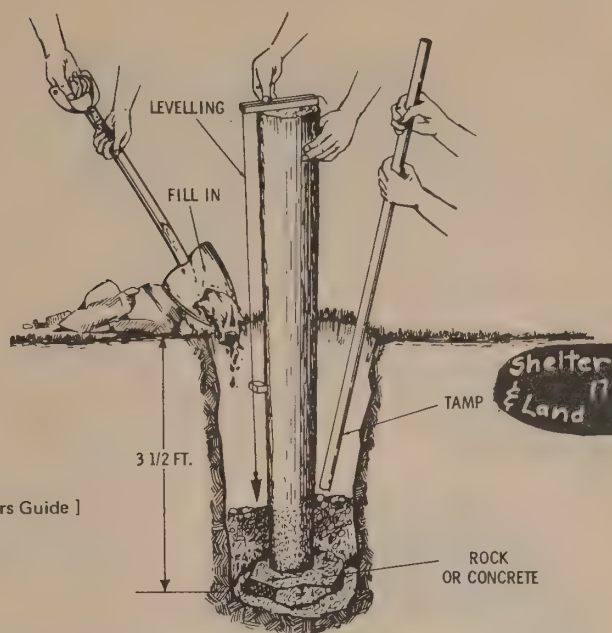

1. A method of erecting a post. Note the large rock or concrete at bottom of the hole. The post is leveled from all angles with a plumb bob.

from: Theo. Audel & Company 4300 West 62nd Street Indianapolis, Indiana 46206

[ Carpenters and Builders Guide ]

## Fastening Tools

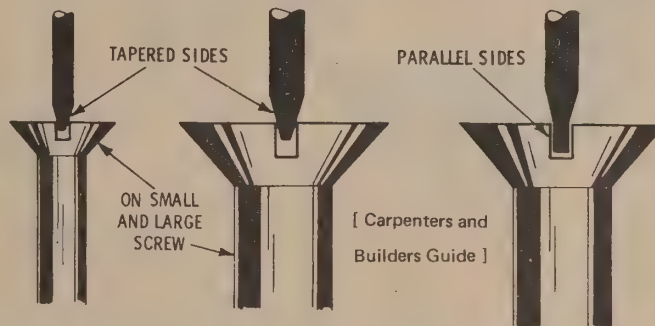
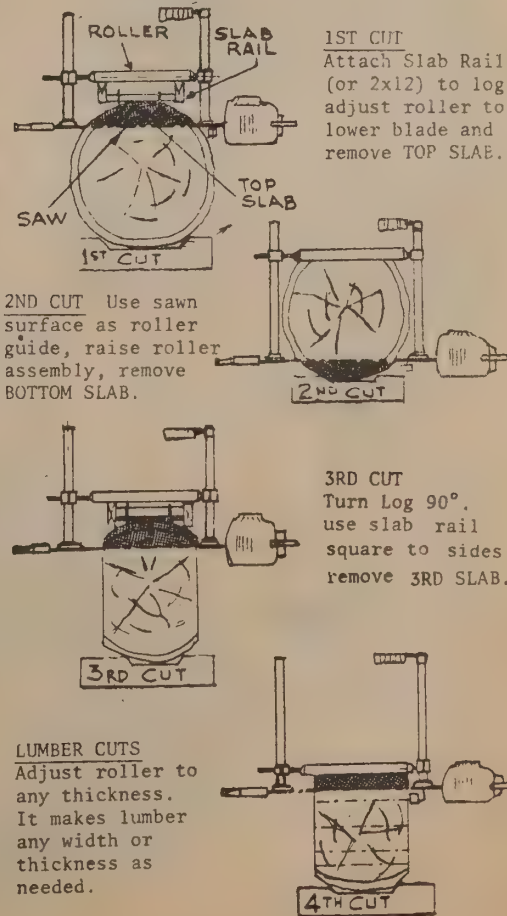

Fig. 7. The end of a screwdriver should be shaped so that its sides are parallel. A screwdriver whose end is tapered can be used, but considerable downward pressure must be exerted to prevent the screwdriver from rising out of the screw slot. With parallel sides, there is no tendency for the screwdriver to rise, no matter how much turning force is exerted.

IT'S EASY TO MAKE LUMBER WITH THE ALASKAN HERE IS HOW!



LUMBER CUTS Adjust roller to any thickness. It makes lumber any width or thickness as needed.

**Village Technology**

VITA (Volunteers for International Technical Assistance) is the only source of specific practical information on small-group technology that we've found. But what a source. They have prepared a two-volume "Village Technology Handbook" for overseas use by the U.S. Agency for International Development that is ideal for rural intentional communities. This handbook now is in revision; the new edition should be available as of December, 1968 - inquire for price.

Also VITA has a catalog of funky tools - Village Technology Center Catalog - available free. For the items listed they will supply plans for making the tools, or rent or sell the items - inquire for price.

VITA has a series of specific papers that cost very little (eg. 30¢). Titles include "Low-Cost Development of Small Water-Power Sites", "How to Salt Fish", "Making Building Blocks with CINVA-Ram", "Solar Cooker Construction Manual".

Source:  
VITA  
College Campus  
Schnectady, N.Y. 12308

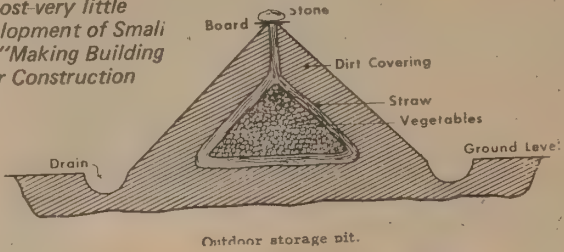
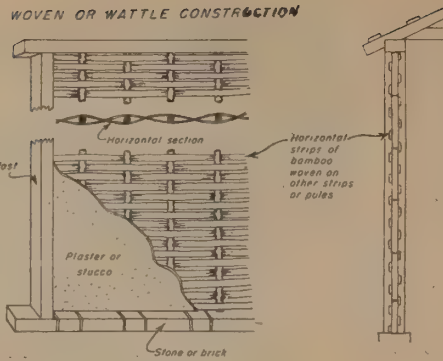
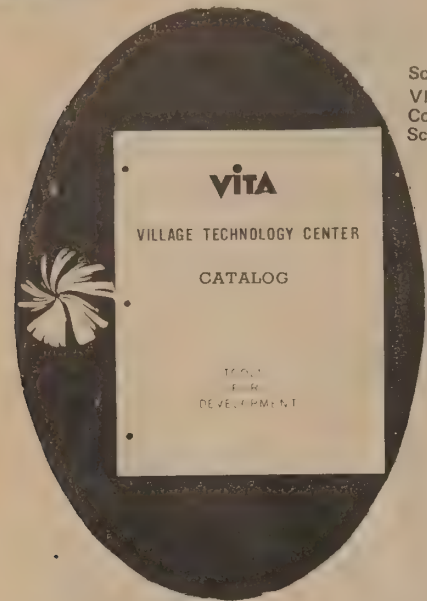

Equipment for which suitable designs are being sought or developed for inclusion in future catalog supplements:

- |    |                          |    |                                |
|----|--------------------------|----|--------------------------------|
| 1  | Animal harness           | 28 | Clothes wringer                |
| 2  | Tractors                 | 29 | Chlorinator                    |
| 3  | Moldboard plows          | 30 | Sterilizer                     |
| 4  | Harrows                  | 31 | Baby incubator                 |
| 5  | Seed planters            | 32 | Baby scales                    |
| 6  | Grain drills             | 33 | Automatic flush toilet         |
| 7  | Cultivators              | 34 | Solar food dryer               |
| 8  | Dusters                  | 35 | Solar still                    |
| 9  | Sprayers                 | 36 | Soil mixer                     |
| 10 | Threshing machines       | 37 | Sifting apparatus              |
| 11 | Winnowing machines       | 38 | Concrete mixer                 |
| 12 | Seed cleaner             | 39 | Concrete block machine         |
| 13 | Rice huller and polisher | 40 | Concrete block forms, wood     |
| 14 | Oil seed press           | 41 | Wheelbarrows                   |
| 15 | Farm cart                | 42 | Flashlight projector           |
| 16 | Rice drying equipment    | 43 | Photo enlarger                 |
| 17 | Incubators               | 44 | Bamboo science equipment       |
| 18 | Brooders                 | 45 | Playground equipment           |
| 19 | Peanut sheller           | 46 | Arc welder                     |
| 20 | Pumps                    | 47 | Spot welder                    |
| 21 | Deep well pump           | 48 | Blacksmith's forge             |
| 22 | Rotary centrifugal pump  | 49 | Sheet metal brake              |
| 23 | Diaphragm pump           | 50 | Sheet metal rolls              |
| 24 | Hydraulic ram            | 51 | Kiln                           |
| 25 | Well drilling equipment  | 52 | Potter's wheel                 |
| 26 | Well casing forms        | 53 | Bobbin winders                 |
| 27 | Sawdust heating stove    | 54 | Spinning and weaving equipment |

**SOLAR WATER HEATER**

**ABSTRACT**

To provide hot water, primarily for washing clothes, in areas where fuel is scarce and sunshine is plentiful.

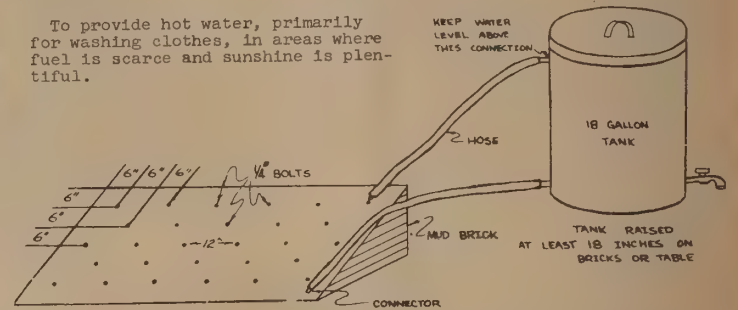
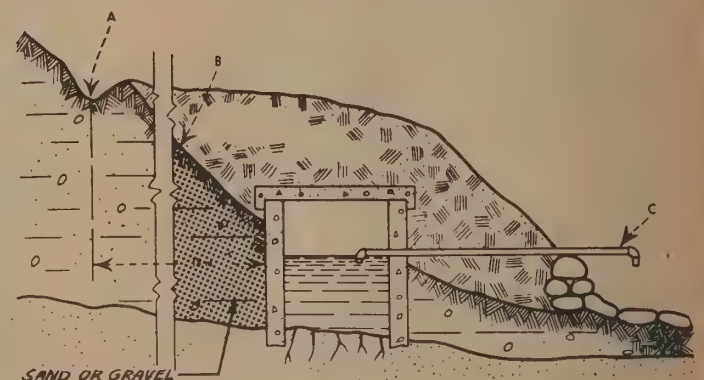

Fig. 33. PROPERLY PROTECTED SPRING (I)



A = Protective drainage ditch to keep drainage water a safe distance from spring  
B = Original slope and ground line  
C = Screened outlet pipe: can discharge freely or be piped to village or residence!

**"BEEHIVE" BUILDING**



The "BEEHIVE" BUILDING, so named because of its shape, is unusually well adapted for use as farm out-buildings (chicken houses, storage sheds and granaries). It is cheap to build because the walls are only 25 cm thick and come together to form the roof. Sun-dried bricks are suitable construction material in dry areas; stabilized earth or burned brick plus a covering of water-proof plaster must be used in areas with high rainfall.

Building instructions only

Cat.No. M-103

**CONSTRUCTION JIG for "BEEHIVE" BUILDING**

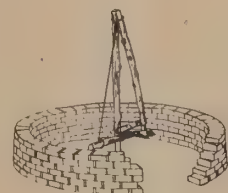

The construction of the "BEEHIVE" BUILDING is simple and can be done by unskilled people using the JIG shown. The JIG is designed to swing completely around while the free end serves as a guide pole. By laying the bricks against the end of the guide pole, the building is kept perfectly circular and the walls are brought in to form the "beehive" shape. Base and fitting only; poles must be provided locally.

Diameter: 3" - Length: 36"

Wt. 30 lbs.

Cat.No. M-103A

**WOODMAKER'S CUTTING BENCH**

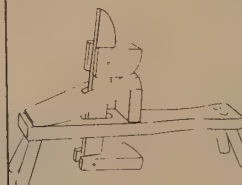

This ingenious CUTTING BENCH has a vise at one end in which a block of wood could be held by pressing on a foot treadle--leaving both hands free to operate tools. It is a very useful device which has application in a number of situations. One of its earlier uses was for holding wooden shingles while tapering with a draw-knife.

Cat No. M-114

Size: 20"x72"x42"

Wt.100 lbs.

**EVAPORATIVE FOOD COOLER**



In warm and dry climates, an EVAPORATIVE FOOD COOLER will extend the period for keeping food fresh and preserve leftovers. It also helps to keep crawling and flying insects away from food.

The COOLER operates on the principle of evaporation of water from the heavy cloth cover which is kept wet at all times by absorbing water from the pan in which the cooler stands.

It will not work in damp and humid areas.

Cat.No. M-83

Size: 17"x13"x57"

Wt. 26 lbs.

**VITA SOLAR COOKER**



The VITA SOLAR COOKER is designed to be sturdy, relatively easy to make, easy to repair and low in cost. It uses the principle of the Fresnel reflector which concentrates light and heat.

The COOKER--when used in areas having more than 2000 hours of sunshine per year--provides the heat equivalent to 500 watts (which will boil a quart of water in 12 to 15 minutes).

Larger models of the COOKER can be provided.

Cat.No. M-73

Size: 52"x46"x50"

Wt. 24 lbs.

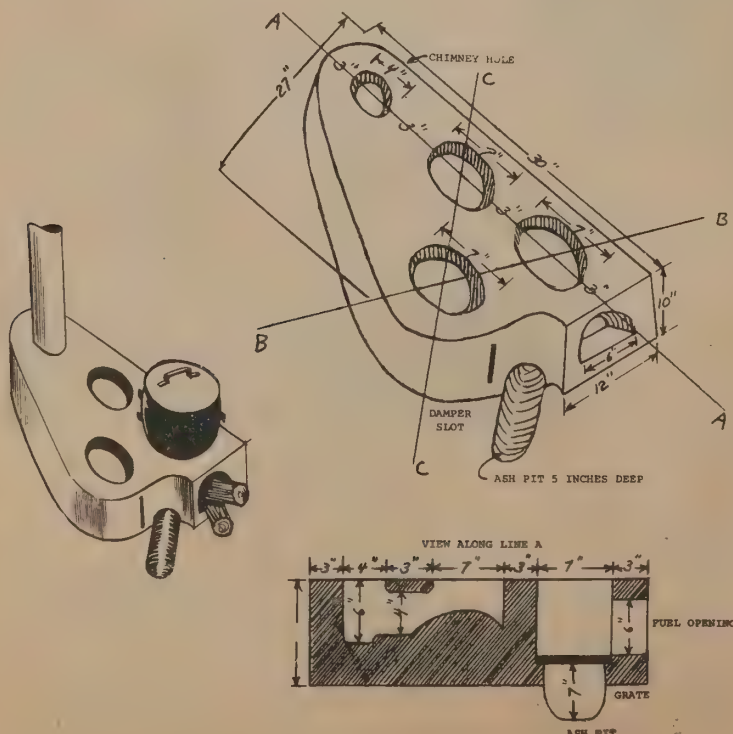

## The Indian Tipi

Tipis are cheap and portable. To live in one involves intimate familiarity with fire, earth, sky, and roundness. The canvas is a shadow-play of branches by day, people by night. Depending on your body's attitude about weather, a tipi as dwelling is either a delight or a nuisance. Whichever, you can appreciate the elegant design of a tipi and the completeness of the culture that produced it.

The Laubin's book is the only one on tipis, but it is very good. All the information you need, technical or traditional, is here, and the Laubins are interesting people.

Later we discovered that the idea of a ventilating pipe underground to the fireplace is the very best way of insuring a clear lodge and the most heat.

It is a joy to be alive on days like this, and when we come back to the tipi, after a long ride or a hike in the mountains, the little fire is more cozy and cheerful than ever. The moon rides high in the late fall nights, and when it is full, shines right down through the smoke hole. Its pale white light on the tipi furnishings, added to the rosy glow of the dying fire, is beautiful beyond description.

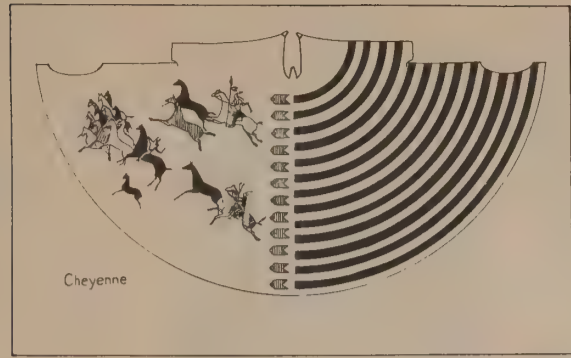
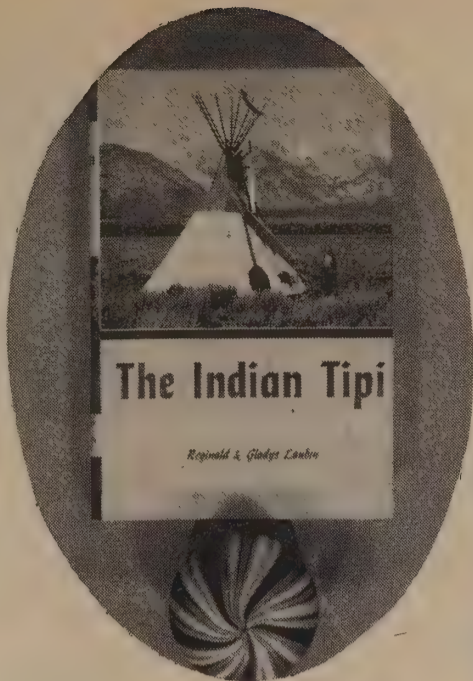

Shelter & Land 19

Indians had definite rules of etiquette for life in the tipi. If the door was open, friends usually walked right in. If the door was closed, they called out or rattled the door covering and awaited an invitation to enter. A shy person might just cough to let those inside know he was waiting. If two sticks were crossed over the door, it meant that the owners either were away or desired no company. If they went away, they first closed the smoke flaps by lapping or crossing them over the smoke hole. The door cover was tied down securely and two sticks were crossed over it. The door was thus "locked," and as safe in Indian society as the most strongly bolted door would be in our civilization today.

The Indian way of attaching peg loops, as illustrated, is not only ingenious but easy and sturdy—far better than either sewn or stamped grommets. Insert a pebble about 3/4 of an inch in size on the under side of the cover about six inches above the edge, at a seam wherever possible, and around this pebble tie a piece of 3/16-inch cord. Double the cord, tie it in either a square knot or a clove hitch about the pebble, then join the free ends in a square knot. Marbles will do if you cannot find smooth round pebbles.

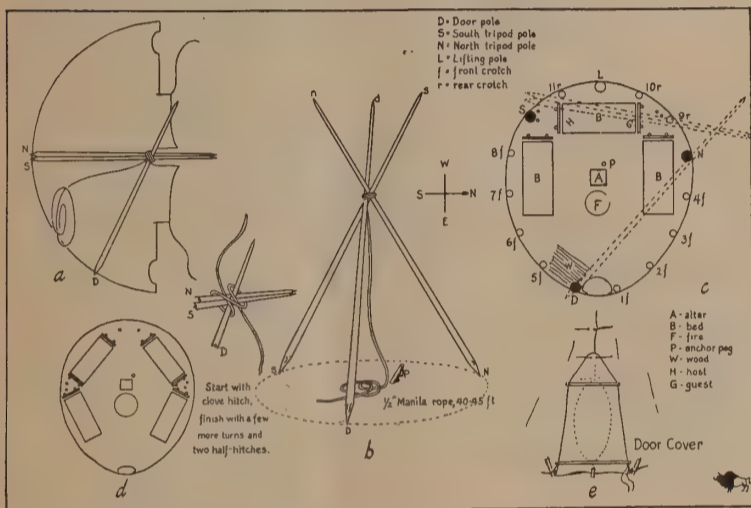

FIG. 3. Erecting the Sioux Tipi.

**The Indian Tipi**  
Reginald and Gladys Laubin  
1957; 208 pp.

**\$4.95** postpaid

from:  
University of Oklahoma Press  
Sales Office  
Faculty Exchange  
Norman, Okla. 73069  
OR  
WHOLE EARTH CATALOG

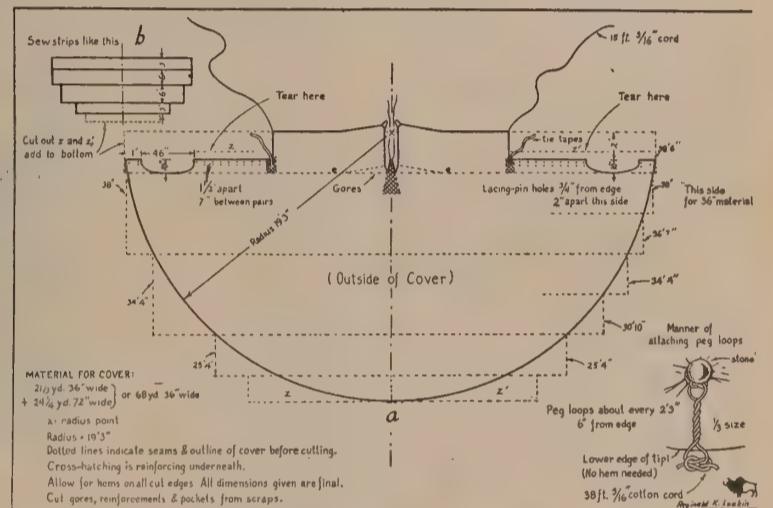

FIG. 1. Pattern for Sioux Tipi (18-foot).

## Tipis

We have word about three sources in the U.S. of ready-made tipis, and so far Goodwin-Cole is still the best—best construction, lowest cost. They also have tipi liners, which you will need if weather is wet or cold.

For the following, shipping weights are undetermined. Inquire, or have the item sent shipping cost C.O.D.

	10 oz. white duck	10 oz. flame treated white duck
10' diameter	\$55	\$83
14' diameter	\$66	\$98
20' diameter	\$108	\$154

10-foot is suitable for nomadic couple; 14-foot for small family. 20-foot for extended family or occasions. Flame-treated is unpleasant; law requires it in some places. Tipis of green, blue, orange, red or yellow drill are available. Poles are available if you're that lazy.

from:  
Goodwin-Cole Company  
1315 Alhambra Blvd.  
Sacramento, California 95816



## Aladdin Kerosene Lamps

Coleman lamps are terrible — they hiss and clank and blind you, just like civilization.

Aladdin is the answer if you need good light and 117ac isn't around. It is bright, silent, and requires no pumping. (It does require some babying to keep the mantle from smoking up; it's like not burning toast.)

British made and efficiently designed, the lamps are available in this country from:

Aladdin Industries, Inc.  
Kerosene Lamp Division  
Nashville, Tennessee 37210

Some of the Aladdins are rather ornamental. The simplest designs are B-139 Font Lamp (aluminum) **\$15.97**

and B-223 Hanging Lamp **\$22.63** (Shade extra: \$2.60)  
C.O.D. the shipping costs.

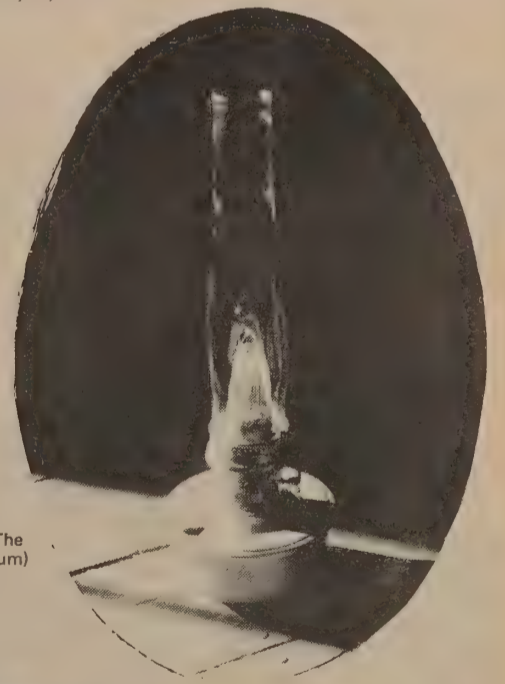

## Man's Role in Changing the Face of the Earth

This book of almost 1200 pages is the result of a major conference held in 1955, sponsored by the Wenner Gren Foundation for Anthropological Research. More than 50 scholars submitted papers, covering almost every imaginable point of view related to man's capacity to transform his physical environment. Though first presented nearly 15 years ago, the facts and insights are richly rewarding today. In my opinion in fact, it is an unsurpassed achievement in assembling pertinent, insightful information of interest not only to serious students of the planet Earth, but to non-trained readers as well.

The three sections of the book are: I. "Retrospect", an historical background; II. "Process", methods and agencies involved in man's interactions with the land; and III. "Prospect", the effects and future implications of man's habitation of the Earth. Some typical subjects covered within these sections include: fire as the great force employed by man; origins and decline of woodlands; man and grass (sic); ecology of peasant life; harvests of the seas; ports channels and coast-lines; and sewerage (don't belittle sewerage—society is structured around it).

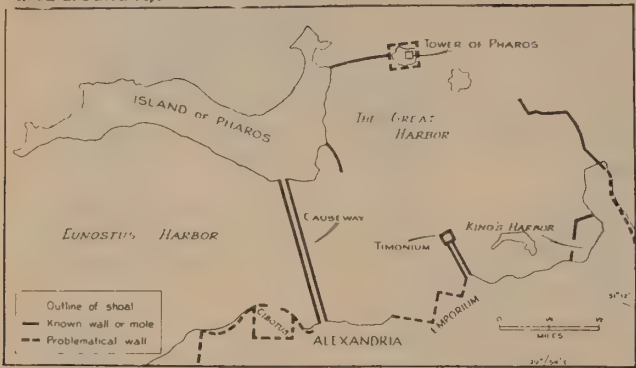

FIG. 106.—Harbor at Alexandria, Egypt, about the beginning of the Christian Era. This book rewards a reader like me because of its minimum of moralizing and its abundant substance. Edgar Anderson, director of the Missouri Botanical Garden in St Louis and without whom such a book as this would be certainly incomplete, pointed out that the average thoughtful person has little inkling of how man has reclothed the world. Even professional biologists have been tardy in recognizing that a significant portion of the plants and animals surrounding us are of our own making. For example, neither Kentucky bluegrass nor Canada bluegrass is native to those places, but came from Europe. The corn belt is a very obviously man-dominated landscape, but the casual observer might never realize that even the grass covered and oak-dotted stretches of what looks like indiginous California vegetation came uninvited from the Old World along with the Spaniards.

[Reviewed by Richard Raymond]

## Two Mushroom Books

Finding a strange, slimy, luminous colored growth on dark rotting wood is surprise and pleasure; to extend that experience into identifying it and possibly EATING it is even better. For the beginner one batch of mushrooms can occupy a whole day, from finding them, through waiting for a good spore deposit and making a decision, to cooking them. An efficient guidebook is essential to avoid frustrations.

The McKenny book is compact, but not especially well organized for use. It contains clear and concise descriptions of 83 varieties of fungi, some of them peculiar to the Puget Sound region, the rest common throughout the U.S., and 33 black-and-white and 48 color photographs. There is also an article on mushroom poisons and the many fine recipes make one want to rush to the woods and immediately gather baskets of Chanterelles, Morels and Ceps. Not so easy!

Smith's book, which I prefer, is more technical in language and scope, although, as a field guide, it avoids identification methods involving microscopes and chemicals. It is much more complete, covering 188 varieties with a black-and-white photo of each plus 84 color photos, and it is organized in keys which are super to use if you like being methodical. It is not necessarily true, however, that it is quicker to follow the system: in thumbing through either book, as in wandering in the woods, luck and perseverance further.

[Suggested and reviewed by Sandra Tcherepnin]

*The Mushroom Hunter's Field Guide*  
Alexander H. Smith  
1958; 1967; 264 pp.

\$6.95 postpaid

from:  
University of Michigan Press  
615 East University  
Ann Arbor, Michigan 48106  
or  
WHOLE EARTH CATALOG

*The Savory Wild Mushroom*  
Margaret McKenny  
1962; 133 pp.

\$3.95 postpaid

from:  
University of Washington Press  
Seattle, Washington 98105  
or  
WHOLE EARTH CATALOG

On a tramp through the fields and forests, carry with you a small jar of butter, creamed with salt and pepper. On finding any edible mushroom (except morels or elfinsaddles), collect a few dry sticks and fire them. Split a green stick (alder or willow) at one end. Put the mushroom in the cleft, hold it over the fire until tender, season with the butter. Eat from the stick.

from "The Savory Wild Mushroom"

Generally speaking, the plants which follow man around the world might be said to do so, not because they relish what man has done to the environment, but because they can stand it and most other plants cannot.



FIG. 147. A demonstration of man's responsibility in creating new plants. From Kucey, 1958. At the intersection of the main levees of the lower Mississippi Delta. At right angles to it and crossing the main levee, there is the abandoned channel of a former stream, now known as the "ditch." The water levels of the stream are slightly higher than the surrounding country. Their sharp corners are indicated on the map by hatchures. The road has been run along the lower levee, and houses have been built along the opposite one. The property lines as in many old French settlements produce a series of long narrow farms, which for our purposes serve as so many experimental plots. Each farm has its house on a low ridge with a long entrance drive connecting it across a swale to the public road on the opposite ridge. The farms (including a score of others which are out of sight to the left of the figure) were originally essentially similar. At the point where the ditch joins the levee is a large population of *Iris hexagona gigantea-caerulea*. Behind the levee on which the houses were built, *I. fulva* grows on the lower ground as well as farther upstream along the ditch. The key fact to be noted is that the hybrids are on only one farm, that they are abundant there, and that they go up to the very borders of the property on either side. Nature is evidently capable of spawning such hybrids throughout this area, but not until our farmer unconsciously created the new and more or less open habitat in which they could survive did any appear in this part of the delta. (See Anderson, 1948, pp. 1-11, 94-98, for a more complete discussion.)

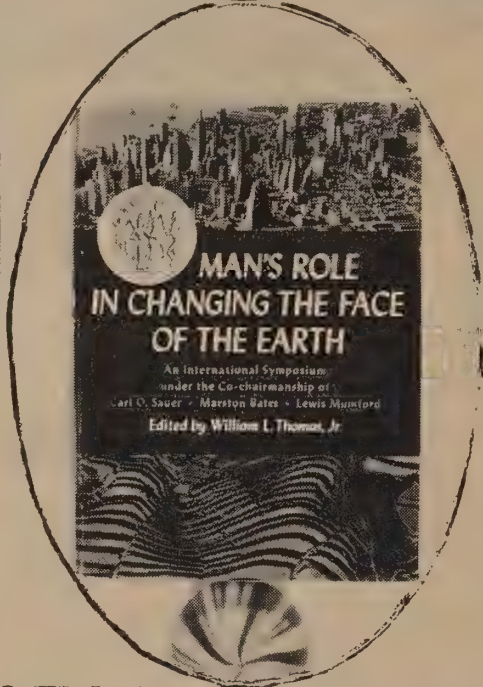

Man's Role in Changing  
the Face of the Earth

William L. Thomas, ed.  
1956; 1193 pp.

\$15.00 postpaid

from:  
University of Chicago Press  
11030 South Langley Ave.  
Chicago, Illinois 60628  
or  
WHOLE EARTH CATALOG

THE SOCIAL REVOLUTION



Courtesy of Kerem Haysel Tezucelam

Almost every change in environmental conditions which man can make results in some change in the water economy or water budget at the earth's surface.

The pressure for beef supply from the grasslands is very rapidly depleting the potential for protein. Where the plow went ahead of the cow, we have been able to measure the reduction in soil capabilities. The protein content of the wheat now grown on the eastern edge of the grassland area has been dropping decidedly. Where once it ranged from 19 to 11 per cent, it is now 14-9 per cent.

These are all very good ideas, but I've got something else that is very much more important. Every time you get where there is one of these populations of plants, find a large, flat rock, in the shade if necessary; sit down upon it for at least fifteen minutes by your wrist watch; and do not try to think about your clematises. Just think what a nice day it is, how pretty the flowers are, and the blue sky. Think how lucky you are to be doing this kind of work when the rest of the world is doing all the awful things they do not want to do. Just let your mind alone. Now, I am not joking. Please do this, by the clock if necessary.

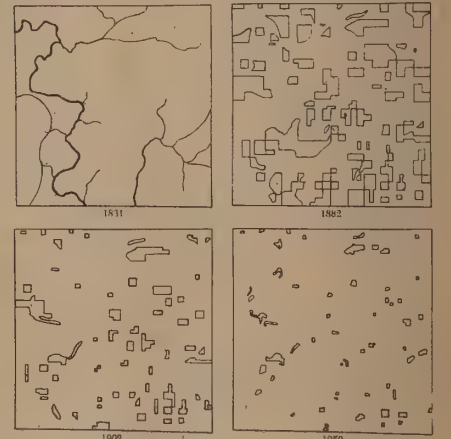

FIG. 147.—Changes in wooded area of Cariz Township, Green County, Wisconsin (80°54' W., 43°30' N.), during the period of European settlement. The township is six miles on a side and is drained by the Pecatonica River. The shaded areas represent the land remaining in, or reverting to, forest in 1811, 1882, 1902, and 1950.



164. COPRINUS ATRAMENTARIUS (Inky Cap)

Edibility. Edible, but some people experience a peculiar type of intoxication from eating this species and afterward drinking an alcoholic beverage. I have now discovered three people in Michigan with this type of sensitivity.

from "The Mushroom Hunter's Field Guide"

## KEYS TO FAMILIES

1. Gills turning black and "melting" at maturity ..... *Coprinus*, in the family *Coprinaceae*
1. Gills not liquefying at maturity ..... 2
2. Gills free from the stalk ..... 3
2. Gills attached to the stalk ..... 6
3. Spore deposit chocolate brown to blackish and mature gills the same color; ring present on stalk ..... *The Agaricaceae*
3. Spore deposit and mature gills paler ..... 4
4. Spore deposit pink to vinaceous or reddish; mature gills about the same color ..... *The Volvariaceae (Pluteus magnus)*
4. Spore deposit white (greenish in one) ..... 5
5. Volva present around base of stalk or remains of outer veil present on the cap ..... *The Amanitaceae*
5. Volva absent; inner veil present; cap if scaly with the scales ingrown and usually of appressed hairs (fibrillose) ..... *Chlorophyllum* and *Leucoagaricus*
6. Spore deposit white to pale lilac, yellow, or pinkish buff ..... 7

from "The Mushroom Hunter's Field Guide"

## Organic Gardening

### How to Grow Vegetables and Fruits by the Organic Method

In the month that I have had my copy of "How to Grow Vegetables and Fruits by the Organic Method," I have browsed in it and referred to it for so many different reasons, out of so many different moods, that I can't decide if its resting place on the shelf is among my other "how-to" books or somewhere between the poetry and books on oriental religion.

But I shall worry about that problem when the time comes, if it does. Right now I'm digging into it so often and with such delight it doesn't need a place on a shelf. I keep it in handy reach on the dining room table.

This book is the definitive manual on organic gardening. It is loaded with information, 550,000 words spread over 926 pages. It is wonderfully illustrated with pictures that are precise and useful, as well as pleasing to the eye. In a pleasant, relaxed prose style, the style of people who obviously have spent more time in the garden than in the library but who at the same time are so confident of what they're saying their words ring hard and true, the editors of this manual have gathered together every fact that one would need to know to become a successful organic gardener, almost anywhere in the United States.

### Vitamin Losses

Vegetables to be cooked should be handled in the same manner as salad vegetables. Gather immediately before using or else wash, dry and store in a cool place. If they are left at room temperature and in the light, much folic acid, vitamin B<sub>2</sub> and 50 per cent or more of the vitamin C in most fresh vegetables can be lost in a few hours.

### Inoculate Garden Legumes

If you are planning to grow any beans, peas or peanuts in your garden this spring, why not take time out to inoculate the seed with nitrogen-gathering bacteria? It will certainly be worth your while.

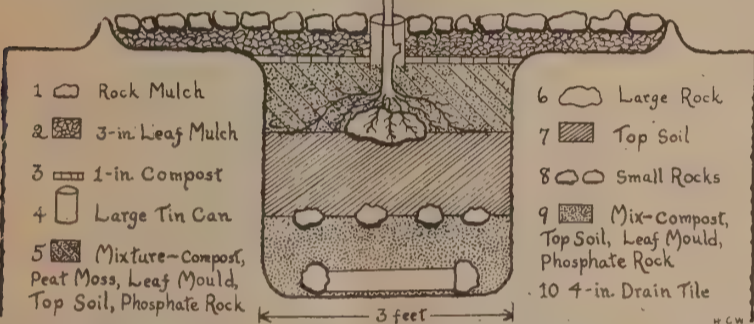

Several "secrets" are involved in this diagram. In addition to digging an outside hole and using the large center stone, you also mulch with rocks and leaves and install adequate drainage.

This book has another quality one does not always find in gardening manuals: it is well organized. The first part is about the soil; the second part is about vegetables, the third part is about fruit, and the closing pages are devoted to nut culture and herbs.

In Section one, there are chapters on how to improve the soil; make compost; start plants from seed; watering and irrigation; when to harvest; fall and winter gardening; controlling insects; greenhouse gardening.

Section two looks closely at some 100 vegetables, giving a page to each vegetable, artichokes through zucchini, and what amounts to a brief essay that describes the history, vitamin content and how to raise each individual vegetable.

Another section does the same with some sixty varieties of North American fruit, from apples and apricots to water-melons and youngberries.

In addition, there are scores of charts and graphs that provide a complete planting guide for all the listed vegetables and fruits. Each geographical region of the United States and its peculiarities are accounted for. One table, for instance, is titled, "Planning Guide for a Family of Five in Washington." Categories of information for gardening in Washington include planting dates, growing period, length of the garden row, amount of seed, depth to plant, distance between rows, and distance between plants.

The entire book is that detailed on every subject it takes up.

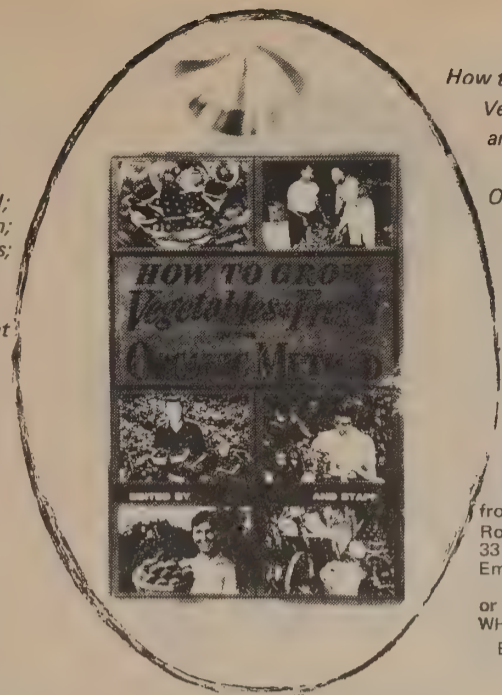

### How to Grow Vegetables and Fruits by the Organic Method

ed. J.I. Rodale and Staff

1961; 926 pp.

\$10.19

postpaid

Shelter & Land

from: Rodale Books, Inc. 33 East Minor St Emmaus, Penna

18049

or WHOLE EARTH CATALOG

### A Tier-Shelf Bed for Mushrooms



One need not, however, intend raising food for a family of five before this book can be useful to you, and a pleasure. I find it absolutely stimulating just as reading matter. It's pleasing in the way that thumbing through a catalog filled with delights you crave can be pleasing. Browsing in this book reminds one of fundamental things, of soil and water and air, and one's own involvement in the natural scheme of the world. The book is beautiful in the way that native crafts are beautiful: it's alive aesthetically at the same time that it's useful. That's more than one can say about most novels. I own very few books I'd rather have than this one. I recommend it to gardeners of all shapes and sizes, and to aware people in general who enjoy reading books whose themes, images and metaphors are drawn from the world of nature.

[Reviewed by Gurney Norman]

But we are more concerned here with the "meat-eaters"—birds which prefer to eat millions of insect life. A few birds prefer an all-insect diet. They include barn swallows, swifts, house wrens, gracklers, flycatchers, brown creepers and some of the several species of warblers. Their bills are long and straight, or long and curved; or they may be short and whiskered; whippoorwills and the nighthawk family belong to this group.

## ABC and XYZ of Bee Culture

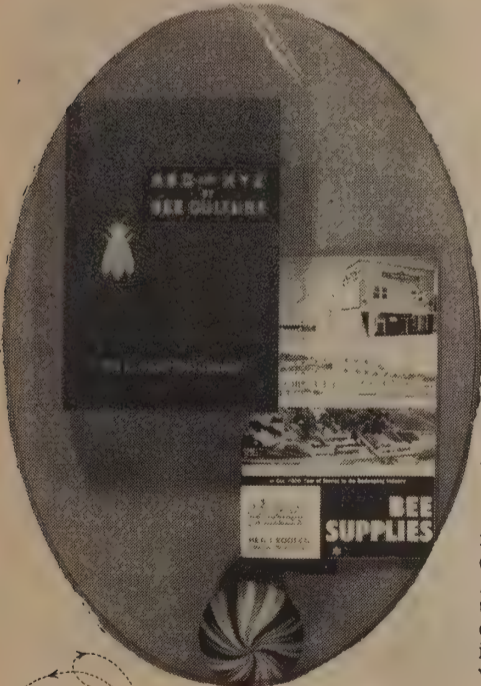

The first edition of this authoritative book was written in 1877 by Mr. A.I. Root. The current edition, the 33rd, is edited by Mr. E.R. Root, with the help of H.H. Root and J.A. Root. You get the picture.

We've been told by several people that bee-keeping is one of the easiest ways to make extra money with little effort and a certain amount of down-home adventure. If you are what you eat, food from flowers is hard to beat.

From whatever standpoint—commercial, nostalgic, or amateur scientific—this is a fascinating and useful book. The Roots also have a catalog of bee supplies, a beginner's book (*Starting Right With Bees*), and a magazine (*Gleanings in Bee Culture*—monthly, \$3.00 per year).

[Suggested by Tassajara Zen Center]

**MARKETING HONEY.**—The bee-keeper with four or five colonies of bees will have no difficulty in selling honey to his neighbors. It soon becomes known that he has a few hives of bees and the people in the vicinity, feeling that they can buy "real honey," will go to the neighbor and pay good prices furnishing their own utensils. If the honey is of first quality there is no trouble about selling the entire crop from the doorway.

*Starting Right With Bees* Catalog Free  
100 pp.  
\$1.00 postpaid

from: The A.J. Root Company Medina, Ohio 44256

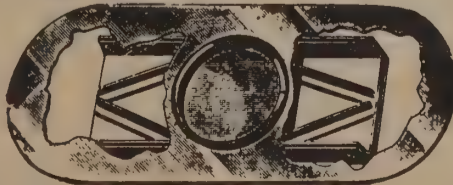

**Porter bee escape.** The two V-shaped prongs are made of thin strips of brass and are so sensitive that they spread easily to let the bees through at the apex. After the bees pass the springs, the points fly back to position, shutting off a return. If the prongs are bent or damaged they should be reset to 1/16-1/8-inch apart.



## Universal Mill

I first ran across C.S. Bell's grinders at the Keams Canyon trading post between the Hopi and Navajo reservations. Then I found one in the VITA catalog: "grinds coffee, corn, soy beans, sugar, mixtmal (for tortillas or arepa), garbanzo, seeds, peppers, spices, cocoa, peanuts, wheat, meat, salt, oats, buckwheat, bananas. . . and like products (wet or dry)." So we ordered one and here it came, with all the grace and precision of a fire hydrant—I had to file the main axle for an hour to get it into the handle. It's fire hydrant red too. But sure enough it grinds stuff and doesn't cost much. C.S. Bell also has power driven grinders and a hand corn sheller.

La Campanita

\$11.55 8 lbs. shipping weight

from: The C.S. Bell Company Hillsboro, Ohio 45133



*ABC and XYZ of Bee Culture*  
A.J. Root etc.  
1877. . . 1966; 712 pp.

\$5.50 postpaid

In cool weather, so far as conditions will permit the time selected for handling the bees should be between 10 o'clock in the morning and 3 in the afternoon. In warm weather the operator should never stand in front of the entrance—always to one side. First, a little smoke should be blown in the entrance. The cover should be lifted gently and more smoke blown between the cover and the hive before the hive is opened. More par-

The Way Things Work

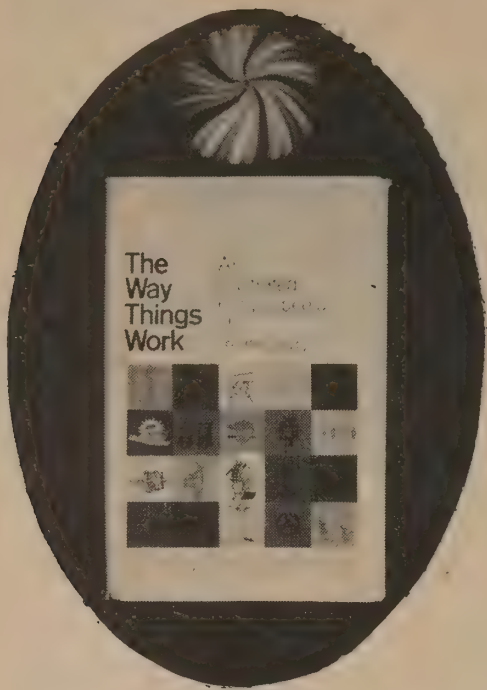

The Way Things Work

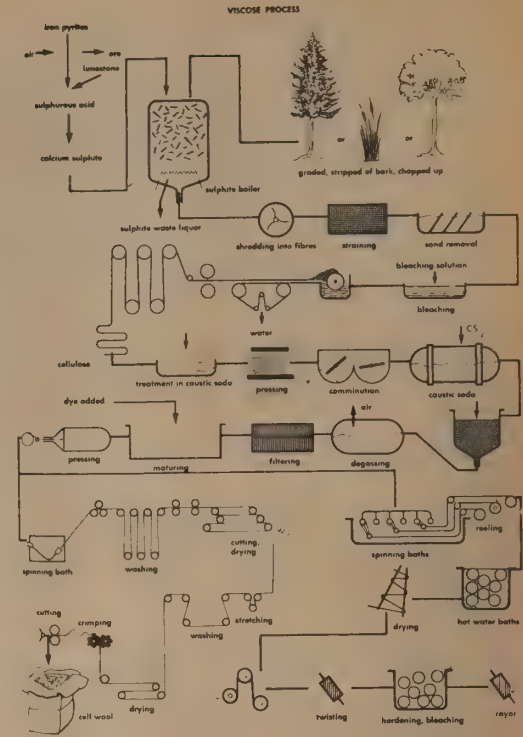
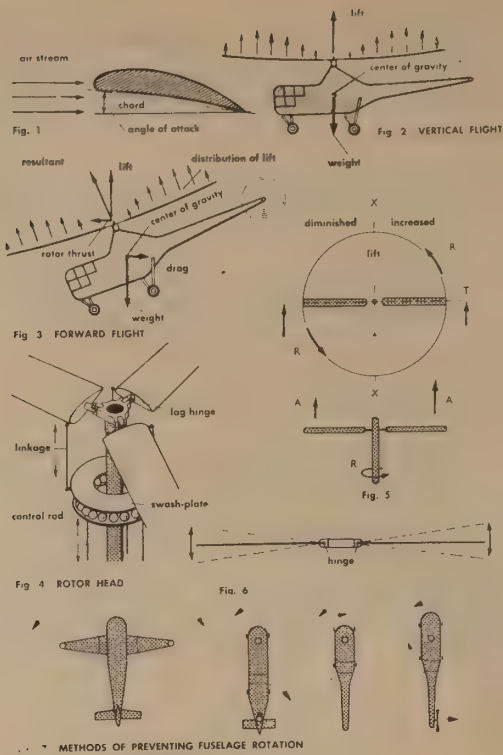

22 Industry & Craft

The Way Things Work  
1967; 590 pp.  
\$8.95 postpaid

from:  
Simon & Schuster  
630 Fifth Avenue  
New York, N.Y. 10020  
or  
WHOLE EARTH CATALOG

Best book for the bathroom we've seen. Nibble your way to knowledge of technology. Each two pages of the book is a bunch of text and a bunch of diagrams on all the big and little gadgets and processes you can think of, ball-point pens to data-processing. If you develop time travel, it might be interesting to take this book back to the sixteenth century and leave it under some European's pillow. (Now think about contact with alien civilizations.)

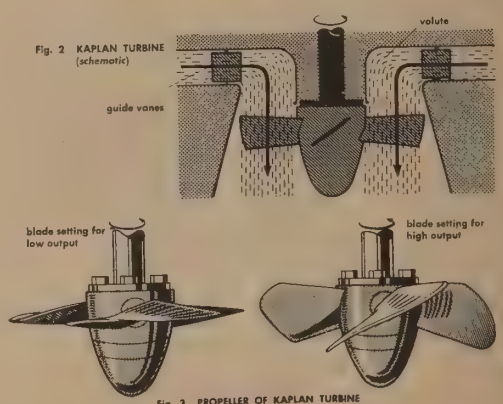
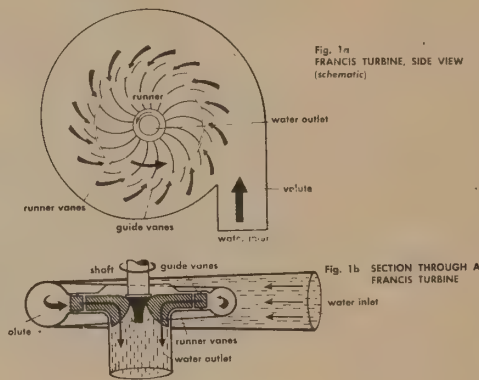

Introduction to Engineering Design

Out of a whole section of books on design in the Engineering Library at Stanford, this book looked far the best. Recently Steve Baer (dome and solar designer) came across it on our editing tables, sat down and paged, then got up and hurriedly wrote a letter to a friend about the book and its author. I asked Steve to pick out some useful quotes and pictures and he wouldn't. "Look anywhere you open it," he advised, then ordered a copy.

Contents of the book include: The Engineering Problem Situation, Design Project Organization, Information and the Need Analysis, Identification of the Problems, Information Sources, Synthesis of Alternatives, Estimation and Order-of-Magnitude Analysis, Engineering and Money, Preliminary Design, Engineering Problem Modeling, The Iconic Model, Conceptual Representation, Expansion of the Criterion Function, Checking in Engineering Design, Optimization, etc.. etc.

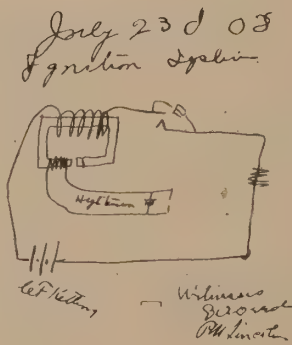

Introduction to Engineering Design  
Thomas T. Woodson  
1966; 434 pp.

\$9.95 postpaid  
from:  
McGraw-Hill Book Company  
Princeton Road  
Hightstown, N.J. 08520  
Manchester Road  
Manchester, Missouri 63062  
8171 Redwood Highway  
Novato, Calif. 94947  
or  
WHOLE EARTH CATALOG

Fig. 6.2 A sketch that changed automobile ignition. (Courtesy General Motors Corp.)



Fig. 7.4 Possible water channel sections. Water supply project for mountain cabin.

WATER SUPPLY FOR MOUNTAIN CAMP

For another simple example, let us estimate how we would bring water from a running stream into a tank (let's say a 50-gallon gravity tank) to supply water for a vacation cabin in the woods. A natural supply point is 100 ft away upstream, guaranteeing among other things a clean, continuous water supply. Our problem is transport. Shall we use pipe, an open rock-lined channel in the ground, or a wooden flume or trough? See Figure 7.4.

As we think about this, we discard the open channel in the ground as too easily contaminated. The pipe could be laid on the ground; and the wood flumes could be suspended from tree trunks and possibly covered as shown by the dashed "board" in the illustration. Thus, we have two reasonable ways of doing this job; the questions now concern cost and convenience.

Next we check the sizes needed. If we wanted the 50-gal tank filled in 15 min, we would need a flow of about 4 gal/min. This is a stream of water about as big as a person's finger when the water is flowing two feet per second, as shown by the equation in the footnote† deriving the cross-sectional area, A, of the stream.

This area would require a pipe one inch in diameter. If we were using the wood "vee" channels, we would need two boards each about three inches wide to avoid splashing over, or one-half board-foot per running foot of channel (per foot of channel length). (A board-foot is one square foot of wood, one inch or less thick.)

Now we need to arrive at costs. The most convenient reference is a broad-coverage catalog (such as that of Sears, Roebuck), in which wood, metal, and other supplies can be found listed at retail prices. Of course, one can also phone the retail plumbing or lumber suppliers. In any case, we find

- Wood: 15¢-20¢ / board-foot in the sizes we need
- 1 in. iron pipe: 30¢ / ft
- ¾ in. copper pipe: 58¢ / ft (One size smaller than iron pipe for the same flow rate.)

Assuming one-half board-foot for each running foot of wood channel, the comparisons are

- Wood: 10¢ / running foot, materials only
- Iron: 30¢ / running foot, materials only
- Copper: 60¢ / running foot, materials only

Since we would do the work ourselves, the cost of labor is disregarded, and it seems that wood should be our choice. On one final check though, we ask whether these are all the choices. Someone suggests plastic pipe, so we look that up: It is corrosion-resistant, flexible, easily connected, sanitary; it has a smooth interior; it could be in one piece and simply laid on the ground. It seems to be a natural choice. The price of ¾-in. diameter plastic pipe is 10¢ / ft; 1-in. diameter is 16¢ / ft. Considering the labor needed with wood or iron pipe, or the cost of copper tubing, and the plastic's sanitary advantages, the plastic pipe (high-density polyethylene) is certainly the preferred choice.

Thus our final estimate is the use of this plastic tubing, probably ¾-in. diameter at 10¢ / ft.

$$\dagger A = Q/V \text{ (area = flow/velocity)}$$

where  
 $Q = 4 \text{ gal/min} = 1000 \text{ cu in./min} \text{ (1 gal - 231 cu in.)}$   
 $V = 2 \text{ ft/sec} = 24 \text{ in.}/(1/60 \text{ min}) = 1500 \text{ in./min}$   
 $A = \frac{1000 \text{ cu in./min}}{1500 \text{ in./min}} = 2/3 \text{ sq. in.}$

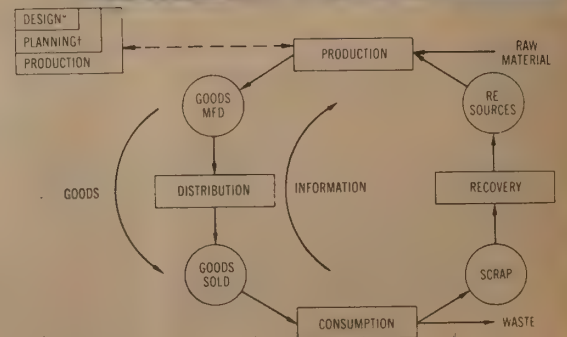
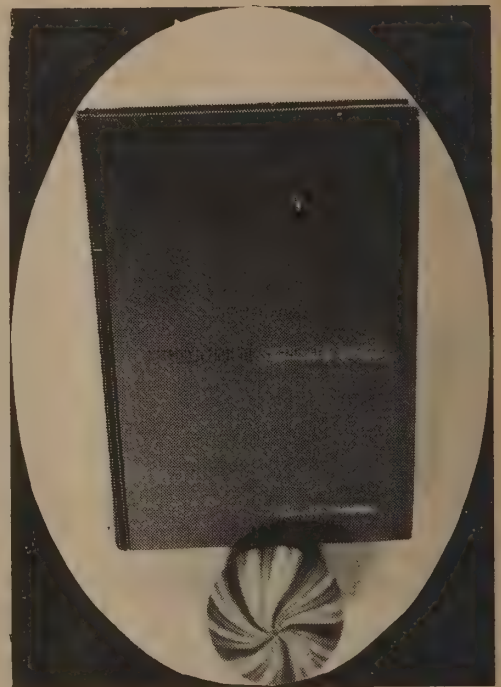

\* DESIGN is a part of PLANNING  
 † PLANNING is a part of PRODUCTION

Fig. 3.7 The production-consumption cycle, showing the place of engineering design.





TRENDS AND DISCOVERIES



*New Scientist is the best evidence we've seen that there are new scientists in the world, young, politically aware, irreverent, active. Every week here's yet another blue New Scientist (if you get behind reading, it's hopeless), full of actual news, critique, and gossip of the research world. The magazine is British, so you get perspective on U.S. accomplishments (flattery nonetheless), and report of worldwide activities unreported in most American journals. The Ariadne column is a gem.*

[Suggested by Steve Baer]

Two physicists at the University of Rochester, by means of a beautiful experiment, have proved Dirac's contention that the interference patterns of light are produced by single photons interacting with themselves

Should sportsmen take dope? Alcohol may form drugs in the brain

Last week, a report of an apparently outstandingly successful experiment in extra-sensory perception appeared in the "establishment" scientific literature for the first time for more than twenty years. Is ESP scientifically respectable at last?

ARIADNE

A device with more than a little of the Daedalus magic about it was unveiled at Stanford University, California, last week. As part of the finals in a mechanical engineering course, students were asked to build a machine capable of climbing a flight of stairs. Everybody's favourite was a robot which strutted to the top, wheeled, fired a small cannon at the onlookers, waved a Nazi flag, gave a rousing rendition of "Deutschland uber Alles", gave the Nazi salute . . . and then blew itself to bits. If all else fails, a million dollar job must surely await this young engineer at California's famed Disneyland.

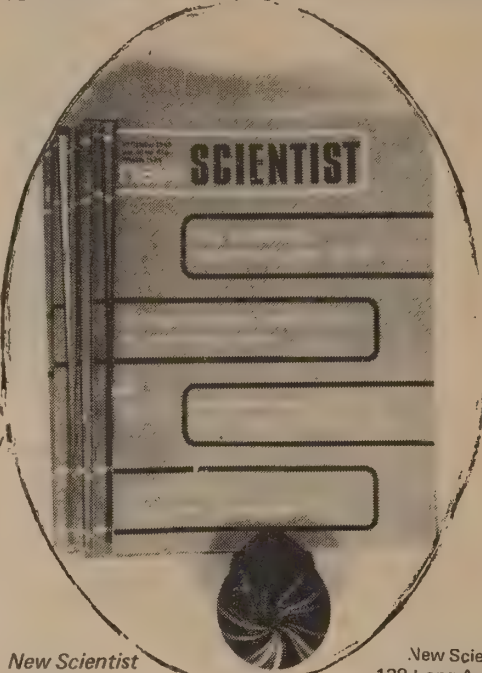

New Scientist \$16.00 for one year (weekly) 128 Long Avenue London WC2, England

**Cutting The Cord Complicates Afterbirth**  
Obstetricians, albeit with the best will in the world, have for about 300 years been meddling unnecessarily with the process of childbirth, and possibly even causing avoidable complications. Dr. M.C. Botha, a South African obstetrician, suggests that by cutting the cord as soon as the baby is born, they may rob the infant of about 90 millilitres of blood—no small measure in a new-born baby. And by tying the cord in the maternal side, before the placenta is delivered, obstetricians may be inhibiting expulsion of the placenta (afterbirth) and causing postpartum haemorrhage.

Recently, Solomon Snyder and Elliott Richelson of the Johns Hopkins School of Medicine, Baltimore, were playing around with molecular models of a number of psychedelic drugs. It suddenly occurred to them that each of their models could be formed into a configuration that approximated certain elements of the drug d-lysergic acid diethylamide, better known as LSD. From this chance observation Snyder and Richelson have now developed an elegant model that can predict a molecule's psychedelic potency from its structure (*Proceedings of the National Academy of Sciences*, vol. 60, p. 206).

All the way with DNA

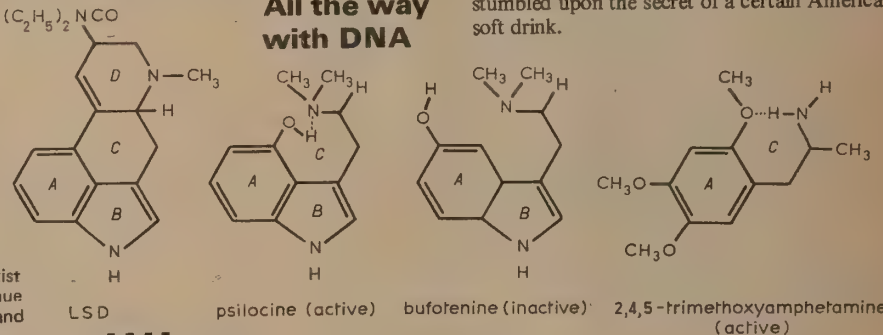

The new substance, however, will be unique in being addictive and *nothing else*—in mathematical parlance the first "trivial" drug. Being totally bland and insipid, and making nobody happier even temporarily, it will neither attract the attention of the Mafia or the kick-seeking young, nor call down denunciation from the elderly, repressed puritans of the Bench. Its undetectable influence will restore the junkies and compulsive pill-gulpers to such normality that they may scarcely notice their dependence on this symptomless nonentity. But Daedalus fears that he may have been anticipated—that he has stumbled upon the secret of a certain American soft drink.

24 Industry & Craft

Cocoons for the millions

House shells of foamed epoxy resin can be built up from the bare earth in a matter of hours using a simple travelling mould controlled by two men. The cheapness and speed of erection offer a realistic approach to the world-wide problem of building low-cost housing

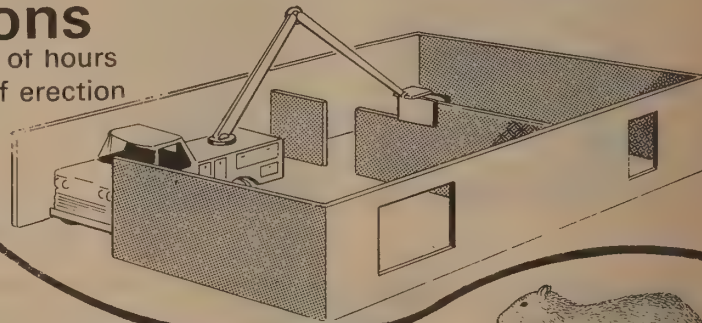

Scientific American

\$8.00 for one year (monthly)

Good old Scientific American.

from: Scientific American 415 Madison Avenue New York, N.Y. 10017 or most newsstands.

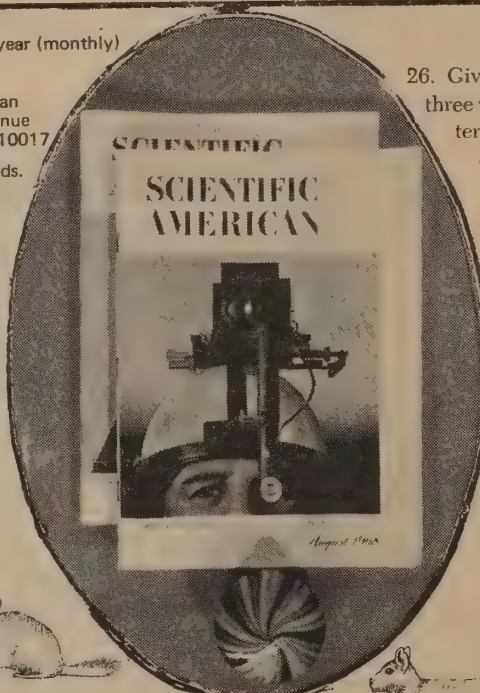

26. Give at least three ways a barometer can be used to determine the height of a tall building.

Here are five: (1) Lower the barometer by a string from the roof to the street, pull it up and measure the string. (2) Drop it off the roof, note the time it takes to fall and compute the distance from the formula for falling bodies. (3) On a sunny day, find the ratio of the barometer's height to the length of its shadow and apply this ratio to the length of the building's shadow. (4) Take barometer readings at the base and the top of the building and compute the height from formulas relating altitude and barometric pressure. (5) Find the superbarometer and offer him the barometer if he will tell you the height of the building. (Thanks to Alexander Calandra.)

Crops without Tillage

A new machine method for planting row crops such as corn and soybeans promises to increase U.S. agricultural productivity by cutting the time usually spent in preparing the land with plow and harrow. In northern farm regions with short growing seasons the "no tillage" planting machines ensure maximum growing time and greater yields per acre; in southern farmlands, after the early-summer harvest of winter-grown grains, the machines allow a second crop to be planted quickly amid the harvest stubble, thus guaranteeing two crops a year.

Reporting on the progress of no-tillage farming at the annual meeting of the American Society of Agricultural Engineers in June, W. R. McClure of the University of Kentucky stated that the time-saving technique had become popular in his area soon after modified corn planters became available in 1967, capable of sowing corn and soybeans in harvest stubble and even in unbroken sod. In addition to the time and money saved by omitting conventional tillage, McClure noted, the no-tillage system affords superior erosion control and, because it leaves natural mulch undisturbed, is far less wasteful of soil moisture than plowing and harrowing are. McClure and his associates at the university conclude that Kentucky farmers could eventually increase their earnings by more than \$150 million a year by adopting the practice.

We have examined the rioter theory from a number of different viewpoints and have found that the Newark and Detroit survey data do not support it. The rioters are not the poorest of the poor. They are not the hard-core unemployed. They are not the least educated. They are not unassimilated migrants or newcomers to the city. There is no evidence that they have serious personality disturbances or are deviant in their social behavior. They do not have a different set of values. None of these factors sets the rioter off from the rest of the community in a way that justifies considering him a personal failure or an irresponsible person. In fact, on some of the "prosocial" items, such as education and occupational aspiration, the rioter compares favorably with the nonrioter or even surpasses him.

Bioholography

The latest example of a technological innovation turning out to be anticipated by a natural process may be in the field of holography, or photography by wave-front reconstruction. The holographic principle is involved in a startling conjecture put forward by a Hungarian investigator to account for the extraordinary sensitivity of the ultrasonic echo-location systems used by bats, whales, dolphins and porpoises to "see" in the dark. This capability has been known for many years to resemble modern sonar, but no satisfactory explanation has yet been offered for the fact that these animals can apparently distinguish between targets of different shapes and can discriminate between their own signal and those emitted by their companions, even though the frequency of the pulses is the same.



Writing in *Nature*, Paul Greguss of the RSRI Ultrasonic Laboratory in Budapest maintains that the characteristics of the animal systems suggest that the animals perceive not only the amplitude but also the phase of the ultrasonic waves, which they can discriminate by using a coherent "background" level of ultrasound as a reference. In other words, the animals are using a version of the holographic technique.

## Industrial Design

*Design clean and clear, and ingenious, and maybe superficial (the debate is underway) is the stamp of two generations of designers that now make up a friendly Establishment. The best window into their domain besides World's Fairs is the British Magazine, Industrial Design.*

[Suggested by Jay Baldwin]

### Junk as art, screens, etc.

In flame cutting, a series of torches cut custom parts from steel sheet. The remainder of the sheet is usually sent to the scrap heap for eventual salvage by steel makers. But at the Reliance Steel & Aluminum Company, someone thinks that the patterned perforations in sheet form might have other uses. Admirers of such industrial art, or people with potential uses for these by-product plates, might want to discuss the matter with Mr. Robert Zurbach, a Reliance V.P., at 2537 East 27th Street, Los Angeles, California.

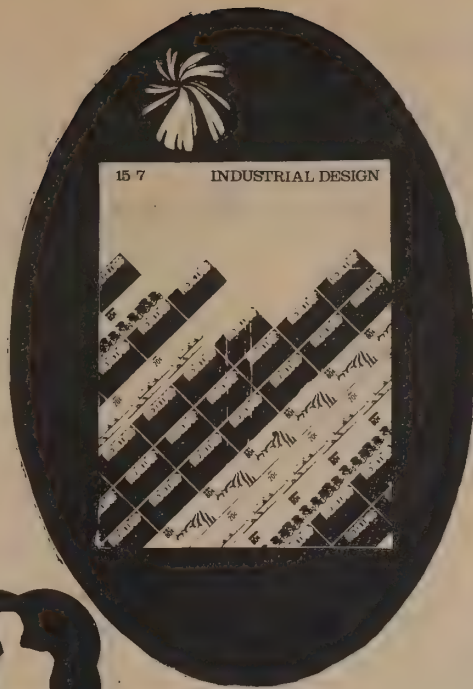
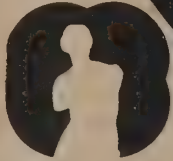

### Industrial Design

\$10.00 for one year (10 issues)

from:

Industrial Design  
18 East 50th Street  
New York, N.Y. 10022

### Suggested bibliography

Chapanis, Alphonse. "Man-Machine Engineering." Belmont, California: Warsworth Publishing Co., 1965.  
Clark, Grahame. "The Stone-Age Hunters." New York: McGraw-Hill, 1967.  
Damon, Stoudt and McFarland. "The Human Body in Equipment Design." Cambridge: Harvard University Press, 1966.  
Edholme, O.G. "The Biology of Work." New York: McGraw-Hill, 1967.  
Ewald, J.R. "Environment for Man—The Next Fifty Years." Bloomington, Indiana: Indiana University Press, 1967.  
Fogel, L.J. "Biotechnology: Concepts and Applications." Englewood Cliffs: Prentice Hall, 1963.  
Gagne, R.M. "Psychological Principles in System Development." New York: Holt, Rinehart and Winston, 1962.  
Gregory, R.L. "Eye and Brain." New York: McGraw Hill, 1966.  
Jones, J.C. and Thornely, D.G. "Conference on Design Method." New York: McMillan, 1963.  
McCormick, E.J. "Human Factors Engineering." New York: McGraw-Hill, 1964.  
McGaugh, J.L., Weinberger, N.M., Whalen, R.E. "Psychobiology" (readings from "Scientific American"). San Francisco: W.H. Freeman & Co., 1967.  
Meister, D. and Rabideau, G. F. "Human Factors Evaluation in Systems Development." New York: John Wiley, 1965.  
Morgan, Cook, Chapanis and Lund "Human Engineering Guide to Equipment Design." New York: McGraw-Hill, 1963.  
Murrell, K.F.H. "Human Performance in Industry." New York: Reinhold, 1965.

Rosch and Burke. "Kinesiology and Applied Anatomy." Philadelphia: Lea and Febiger, 1967.  
Sinaiko, H. Wallace. "Selected Papers on Human Factors in the Design and Use of Control Systems." New York: Dover Publications Inc., 1961.  
Smith and Smith. "Perception and Motion." Philadelphia: W.B. Saunders and Co., 1962.  
Vernon, M.D. "Experiments in Visual Perception." Baltimore: Penguin Book Inc., 1966.

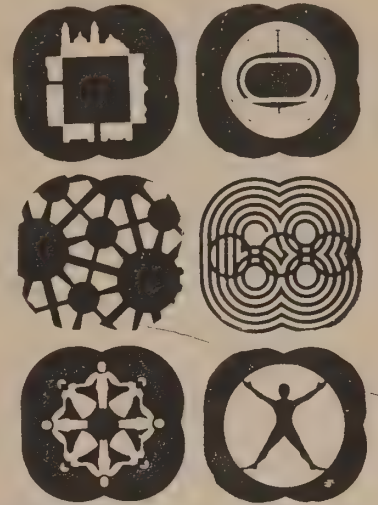

## Are designers obsolete?

A monthly source of the new materials, design tools, technological advances, and components particularly important to active designers.

## MAN/MACHINE SYSTEMS INTERACTIONS

## Product Engineering

Roy Sebern pointed out the main satisfaction of reading *Product Engineering*: in the usual magazines such as *Popular Science*, everything has the tone of "I-wish-they'd-make. . ."; whereas in *Product Engineering* it's "We are making. . ." The magazine has good reporting and excellent editing. Increasingly it is going beyond the question of how to make stuff into why make stuff. Departments include Research & Technology, Mechanical Design & Power Transmission, Hydraulic/Pneumatic Power & Control, Materials & Manufacturing, Product Planning & Management, and the Engineer & His Profession.



## Developments to watch



Igloo-like houses of urethane foam are formed by spraying over fabric and cable forms. Dwellings of almost any size or shape can be built in a matter of minutes.

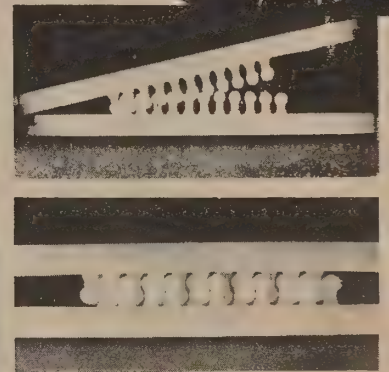

Smooth surfaces of nylon or acetal snap together without need for precise alignment. They hold firmly until pulled apart by a specified force.

### Product Engineering

\$15.00 for one year (bi-weekly)

from:

Fulfillment Manager  
Product Engineering  
P.O. Box 430  
Hightstown, N.J. 08520

## Flying belts ruled by muscle-power

It may be only a matter of time before researchers take some of the controls off jet-flying belts. This step will allow man to rely on his own sense of balance and muscle control while swooping around the sky almost at will.

Inventors of today need not feel as "lone" as they have in the past, partly because of the Inventors Assistance League, which was set up in Los Angeles 18 months ago by Ted De Boer (photo, top right). The League was founded to help the inventor make his brainchild a marketable, commercial reality.

For the movies, the holographic information of an entire square-image field seen from one horizontal plane is contained in a narrow horizontal section of film. Vertical motion of this "strip hologram" at any speed through a laser-illuminated viewing aperture results in a vertically scanned but essentially stationary 3D image. So, says De-Bitetto, if a sequence of such strip holograms of a progressively changing scene is recorded by pulse laser techniques, the strip hologram sequence reconstructs what appears to be a continuous motion of the 3D scene. The sequence of strips is simply moved vertically through the laser-illuminated viewing aperture, at any velocity.

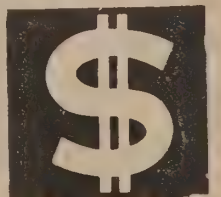

## Clearinghouse

Its full name is "Clearinghouse for Federal Scientific and Technical Information," it's managed by the U.S. Department of Commerce, and it's quite a service. All current unclassified R&D (research and development) done for or by the Government is available through Clearinghouse; this amounts to 30,000 new documents each year. Specific accesses are: U.S. Government Research and Development Reports (December 1,000 new documents twice a month), \$22/year; Fast Announcement Service, for as many as 57 subject areas, delivered constantly, \$5/year; and Technical Translations, twice a month, \$12/year. These are indexes. Once you find what you want you order a paper copy (hard copy) for around \$3 or micro-film (microfiche) for around \$65. The following examples of listings are from the Fast Announcement Service.

[Suggested by Jon Dieges]

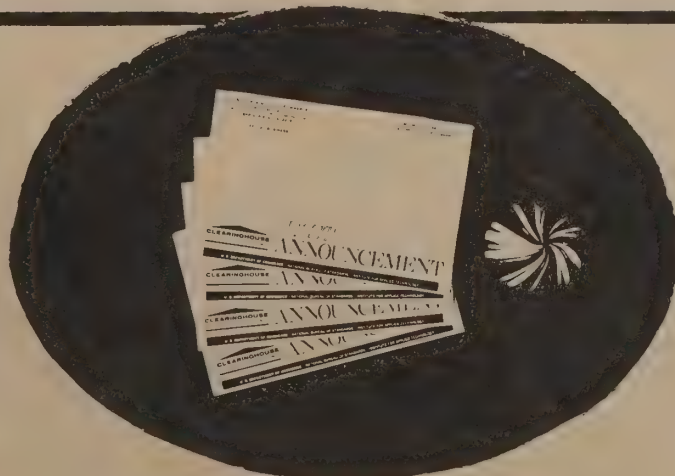

Write for free information and order forms to:

U.S. Department of Commerce  
Clearinghouse for Federal Scientific & Technical Information  
Springfield, Va. 22151

## CLEARINGHOUSE

FOR FEDERAL SCIENTIFIC AND TECHNICAL INFORMATION

The Fast Announcement Service—recommended for those who want more mail.

AD-672 250 — THE THEORY AND PRACTICE OF BLACKMAIL, D. Ellsberg, Rand Corp., Santa Monica, Calif., July 68, 40 p.

AD-674 025 — OPTICAL OR GRAPHIC INFORMATION PROCESSING (INFORMATION SCIENCES SERIES), Defense Documentation Center, Cameron Station, Alexandria, Va., Sept. 68, 229 p. . . DDC bibliography containing 183 references grouped under the following headings: (1) display devices and the theory; (2) character recognition; and (3) pattern recognition.

PB-179 385 — MANUAL ON DESIGN FOR LOW-COST AND AIDED SELF-HELP HOUSING, Dept. of Housing and Urban Development, Washington, D.C., for AID, Jan. 57 (reprinted June 67), 111 p.

AD-674 753 — ACOUSTICAL HOLOGRAPHY OF NONEXISTENT WAVEFRONTS DETECTED AT A SINGLE POINT IN SPACE, A.F. Metherell and S. Spinak, McDonnell Douglas Corp., Huntington Beach, Calif., May 68, 17 p. Describes a configuration based on an extension of the reciprocity theorem and realized by physically interchanging the source and detector. The hologram-recording operation is executed by scanning the source throughout a plane and sampling the resultant wavefront as a function of time with a stationary detector.

Science and Civilization in China, Volume IV, Part 2

Sandy Tcherepnin just asked delicately if I've read Needham's Science and Civilization in China.

Sandy, I don't know anybody who's read Needham's Science and Civilization in China. This is gonna be a reputation review. People say it's a great book. I'll page through, pick out two graphic pictures, two ballsy quotes, and advise everybody to go spend \$35.

Jim Fadiman was even more polite: "What's Needham doing in the CATALOG?"

Nostalgia. This is the volume about Mechanical Engineering. Since many communities and individuals seem intent on re-enacting human technological history, here's their opportunity not to be limited to Western technology. You too can build the first cantilevered bridge, devise the indestructible junk sail (I read about that in Needham's Order and Life, a biology book), and build epic water wheels.

For all we know, an enormous shuck is in progress. Has anybody out there read Science and Civilization in China?

By the time Marco Polo was in China (c. +1285) Man-lifting kites were in common use, according to his description, as a means of divination whereby sea-captains might know whether their intended voyages would be prosperous or not.

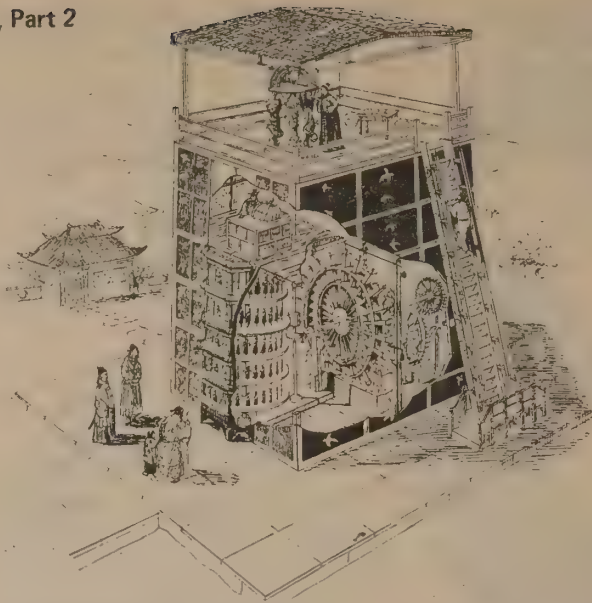
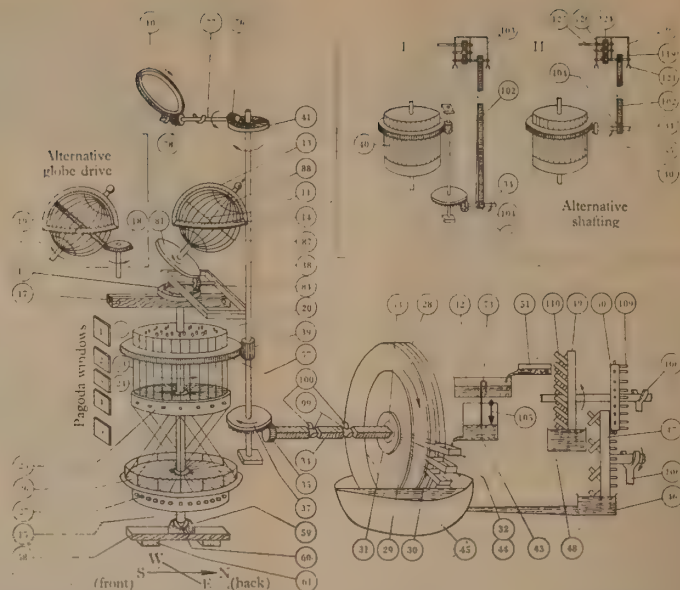

Fig. 650. Pictorial reconstruction of the astronomical clock-tower built by Su Sung and his collaborators at Khaifeng in Honan, then the capital of the empire, in +1090. The clockwork, driven by a water-wheel, and fully enclosed within the tower, rotated an observational armillary sphere on the top platform and a celestial globe in the upper storey. Its time-announcing function was further fulfilled visually and audibly by the performances of numerous jacks mounted on the eight super-

imposed wheels of a time-keeping shaft and appearing at windows in the pagoda-like structure at the front of the tower. Within the building, some 40 ft. high, the driving wheel was provided with a special form of escapement, and the water was pumped back into the tanks periodically by manual means. The time annunciator must have included conversion gearing, since it gave 'unequal' as well as equal time signals, and the sphere probably also had this (see p. 456).



Su Sung's treatise on the clock, the Hsin I Hsiang Fa Yao, constitutes a classic of horological engineering. Orig. drawing by John Christiansen. The staircase was actually inside the tower, as in the model of Wang Chen-To (7). The historical significance of the mechanical rotation of an astronomical instrument (a clock-drive) has already been discussed in Vol. 3, pp.359ff.; cf. also p.492 below.

26 Industry & Craft

Science and Civilization in China Volume IV Part 2 Mechanical Engineering

Joseph Needham 1965 759 pp. \$35.00 postpaid

from Cambridge University Press 510 North avenue New Rochelle, N.Y. 10801 or WHOLE EARTH CATALOG

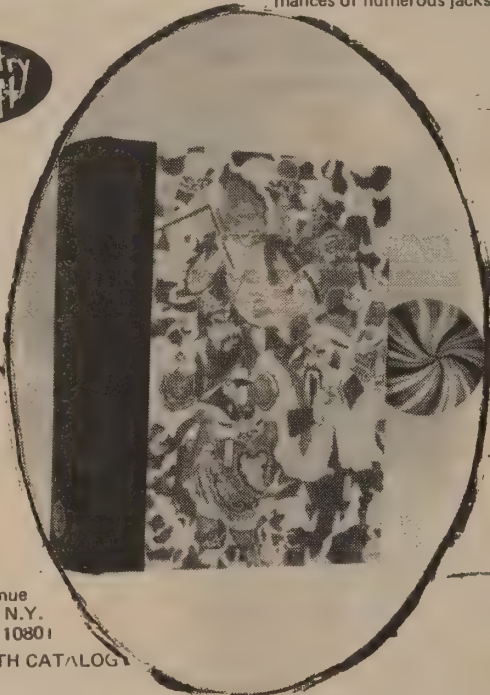

'The undertaking of such a gigantic task single-handed reveals a creative spirit worthy of all admiration. Its completion will make it an unprecedented and epoch-making work in the history of science, and it has already aroused the interest of scholars in every country, who regard it as a masterpiece of modern scientific study. It cannot fail to direct the attention of the learned world to ancient Chinese culture and science.'

Yü FANG-HU in Kuang Ming Jih-Pao (Peking)

'Time only enhances our amazement at Needham's ability to discover in the ocean of datable Chinese literature so many anticipations of present-day scientific knowledge. Even his tentative speculations are as arresting as his conclusions.'

A. W. HUMMEL in American Historical Review



Fig. 707. Page of drawings sent by Cayley to Dupuis-Delcourt in 1853 illustrating an improved Chinese helicopter top which would mount more than 90 ft. into the air. From Hubbard & Ledebor (1). This was the direct ancestor of the helicopter rotor and the godfather of the aeroplane propeller

Allusion has already been made to the 'south-pointing carriage' (chih nan chhe) in Sect. 26i on magnetism, since it was long confused, both by Chinese and Westerners, with the magnetic compass. We know now, however, that it had nothing to do with magnetism, but was a two-wheeled cart with a train of gears so arranged as to keep a figure pointing due south, no matter what excursions the horse-drawn vehicle made from this direction.

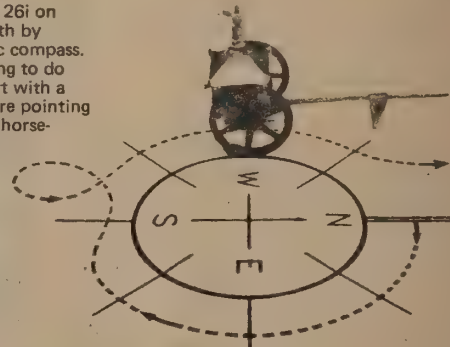
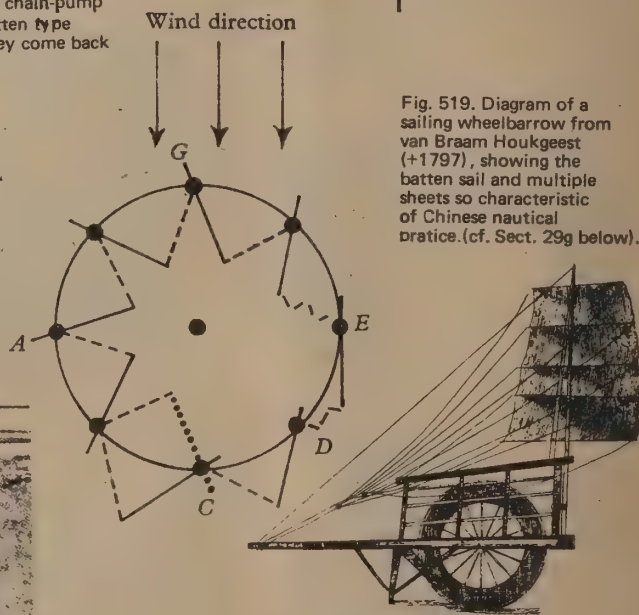
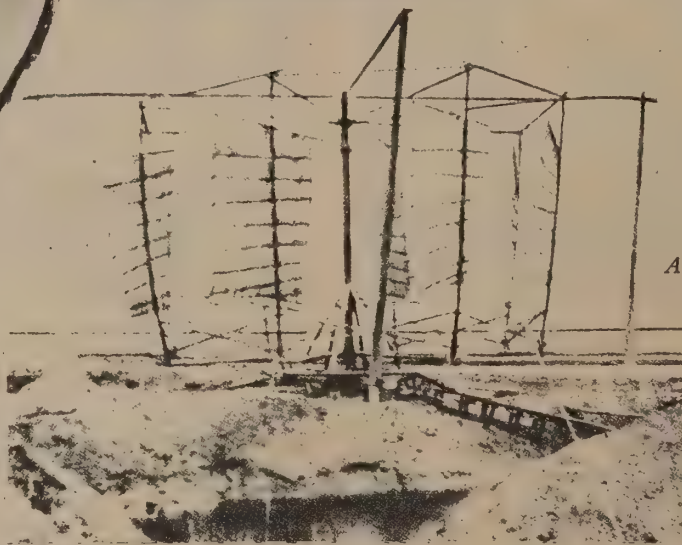

Fig. 519. Diagram of a sailing wheelbarrow from van Braam Houkgeest (+1797), showing the batten sail and multiple sheets so characteristic of Chinese nautical practice. (cf. Sect. 29g below).

Fig. 689. Typical Chinese horizontal windmill working a square-pallet chain-pump in the saltens at Taku, Hopei (king, 3). The fore-and-aft mat-and-batten type sails luff at a certain point in the cycle and oppose no resistance as they come back into the eye of the wind (see diagram on p. 559)



Silvo Catalog

'Tools tools tools tools tools. Brand names. No particular discrimination or evolution. If you know what you want, it's probably here. Prices apparently good. Audel books, for example, cost 15% less than from the publisher or bookstores. Minimum order \$10.'

Jay Baldwin says that it's well known that Sear's line of Craftsman tools are the best low-cost hand tools around, plus they're lifetime guaranteed. If your pliers breaks the clerk hands you new pliers.

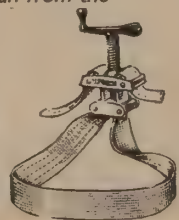

Glendale Respirators — For Dust, Paint, Pneumoconiosis Mists, and Chronic Acid Mist. Superior fit, no metal parts, can be completely taken apart for cleaning and sterilization. Replaceable Filters and Cotton Facepiece (cotton face piece absorbs perspiration, prevents skin irritations).  
GR1000-G20 P—Single Unit \$3.98  
GR2000-G20 P—Double Unit \$5.20  
F10-G20 Box of 10 filters \$1.25  
F11-G20 12 Cotton Face pieces \$1.75

Jorgensen Band Clamps—Canvas, steel band.—For the many applications where clamping round or irregularly shaped sections, such as furniture frames, aircraft sections, tanks, or columns, presents a difficult problem. The pre-stretched canvas band is 2" wider; the steel band (optional if specified) is 1 3/4" wide. Both are quickly adjustable from either end thru the screw head.  
Canvas band is recommended for nearly all uses—it is more easily handled and does not kink; steel band should be used on round shapes only. Self-locking cams hold the band securely.  
Canvas Band—  
6210-A2 6 lbs. 10' band ... \$13.65  
6220-A2 6 lbs. 20' band ... \$16.25

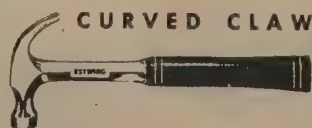

ESTWING CURVED CLAW  
Estwing Claw Hammer — Solid steel — with Leather Grip.  
E16C-E6 P—16 oz. claw ... \$3.59  
E20C-E6 P—20 oz. claw ... \$3.85  
Estwing Original Unbreakable Learner Grip Tools. Forged One-Piece Head and Handle — Strongest Construction Known — Genuine Leather Grip — Withstands All Exposures.

Model M58 Kol Portable Cement Mixer, complete with 1/4 H.P. 110 V. motor. One man can mix 8 cu. ft. of cement an hour with this handy mixer. The 5 gal. pail doubles as a mixing drum and can be removed to pour the cement. The rugged unit is easy to clean, needs no fastening down, can mix a batch in 2 minutes. Farmers, and gardeners can use it for mixing feeds and seeds. Ideal for pouring patios, making barbecue grills, setting fence posts. Instruction booklet incl.  
M58-K10 H—35 lbs.—with motor ... \$39.95  
Model M58X Kol Portable Cement Mixer—Same quality features as above but less 1/4 H.P. motor.  
M58X-K10 H—22 lbs.—less motor ... \$23.25



Silvo Catalog 160 pp.

\$ .25

from: Silvo Hardware Co. c/o Mr. Collins, Advertising Department 107 Walnut Street Philadelphia, Pennsylvania 19106



**Brookstone Tools**

If precision tools are what you need, this gentlemanly company will comply. They're fastidious about what they list, and they are good to the customer. ("We don't lead you on with prices subject to change without notice.")

[This catalog and Silvo suggested by "Armchair Shopper's Guide" (see p. 44)]

**HACKSAW CUTS ANY DEPTH, STRAIGHT OR CURVED**

Remarkable "endless" hacksaw cuts to any depth, even cuts curves, because no frame interferes with blade. All work is done forward of casing, by reciprocating blade. Does "impossible" jobs.

After drilling a hole, blade is easily inserted for sawing out parts of sheets, panels, flooring, etc., as in sketch. Blade breakage is reduced because blade is supported in front casing on 3 hardened steel bearing balls.

Enclosed spring returns blade automatically after each forward stroke.

Well made. Polished chrome plated tube. Polished, nickel plated fittings. Enamel'd casing and body. Uses standard 10" and 12" blades available everywhere. About 15" long. 67A-1293 Endless hacksaw ..... \$7.95

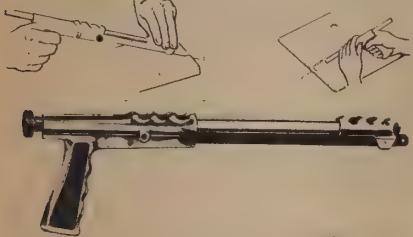

D 8-1/2" shears. All-round shears for shop, office, shipping room, home. Heavily forged for toughest work. Won't bend, even using two hands. Stays sharp — the pair we first tested is still in daily use in our shipping room after a year, on tough paper and cartons, isn't dull yet! Extra-comfortable finger loops prevent fatigue. Precision-fitted to cut filmiest fabrics without raveling. A masterpiece of scissor making.

67A-1357 8-1/2" shears ..... \$6.95  
Six & up ..... Each \$6.25



Brookstone Catalog 23 pp. \$25

**INTERNAL PIPE WRENCHES ARE TROUBLE SAVERS**

from: The Brookstone Company 27 River Road Worthington, Mass. 01098

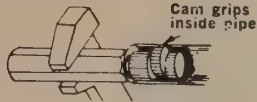

**FLEXIBLE FILES DO WHAT OTHERS CAN'T**

These amazing files are flexible plastic strips impregnated with super-hard aluminum oxide abrasives. You can bend them almost double without breaking. You can snip them into special shapes. Now you can file and polish curved surfaces and otherwise inaccessible places.

They're waterproof, oilproof — for use wet or dry.

Excellent for shaping and fitting, and for fine finishing and polishing all metals (even hard steel) without scratching. Remove burrs, tool marks, corners. Touch up cutting tools. Smooth off sharp edges, even on hard glass and ceramics.

Electrically non-conductive — safe on live circuits. Unequaled for dressing and burnishing contacts, line starters, limit switches, commutators, relays.

Catalog Number	Width in.	Length in.	Thick. in.	Grit	Each
67A-1103	1/2	4-1/2	.040	80 (coarse)	20c
67A-1104	1/2	4-1/2	.040	120 (medium)	20c
67A-1105	1/2	4-1/2	.040	240 (ex-fine)	20c
67A-1106	1/2	4-1/2	.040	320 (polish)	20c
In lots of 10 dozen					\$2.15/doz.

**Miners Catalog**

Mack Taylor, head of Exploration Laboratories, says this is the only Miners Catalog. We're glad it's a good one. [Suggested by Mack Taylor]

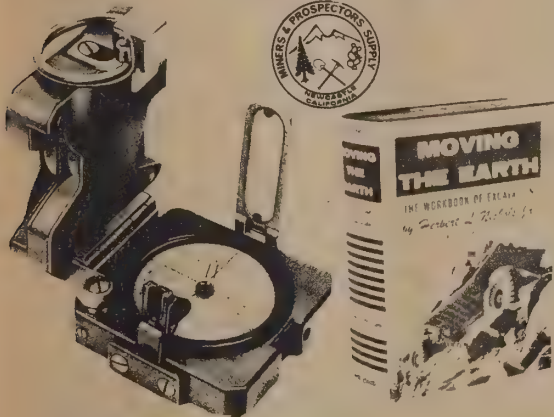

**MODEL G1717 ENGINEERING COMPASS.** Similar to Model G1719 Geological Compass except that it does not have pendulum clinometer, level bubble or extension rule. This is a fine instrument for most engineering measurements.

The compass and optical clinometer scales permit rapid reading of horizontal and vertical angles with a precision unusual in a hand-held compass. Weight with case 9 ozs. Complete..... \$72.50

**ATLAS OF LANDFORMS** by James L. Scovel et al. A terrain study atlas compiled essentially from the series of 100 topographic maps illustrating typical landforms published by U. S. Geological Survey. Text material, aerial photographs and diagrams. Effective guide to land form study. 14 1/2 x 12 1/2, 168 pp., 1965, Flexible binding. \$10.95



Miners Catalog Free 42 pp.

from: Miners and Prospectors Supply 177 Main Street Newcastle, California 95658

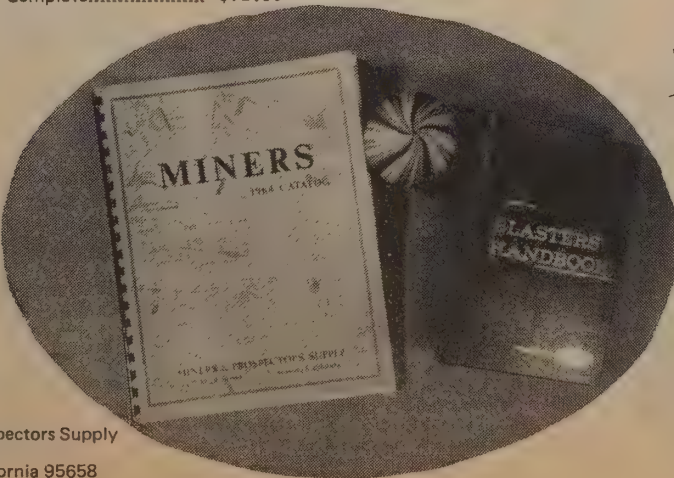

**Blasters' Handbook**

It was the gay bomber of Libre that put us on to blasting as constructive catharsis. With explosives you can cut, dig, shape, and practically whittle. While suppliers are understandably touchy in the city, you can usually get dynamite without heavy credentials in rural areas. It costs something around \$15 for a fifty pound box.

This book, published and updated by Dupont, has been around for 26 years. It is well regarded.

**DIGGING POLE HOLES**

Dynamite is useful in digging both shallow and deep holes for fence posts and for telephone and other classes of poles.

In hard ground and medium shale, any soft surface material should first be removed to the full diameter of the desired hole. For shallow holes, a small borehole should be drilled or punched along the axis of the pole hole to about the depth required and loaded with a small charge of 40 per cent "Red Cross" "Extra" primed with blasting cap and fuse or an electric blasting cap. Double caps are recommended as a safety precaution (Figure 31-A-1). For best results, the hole should be fully stemmed. The blast will loosen the hard material and aid removal by shoveling.

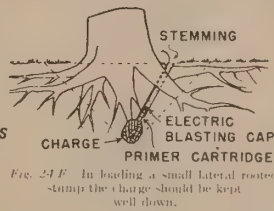

Fig. 24-F—In loading a small lateral root-stump the charge should be kept well down.

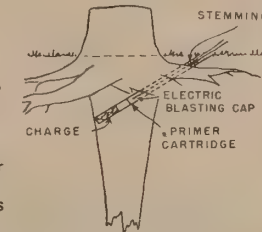

Fig. 24-G—When blasting tap rooted stumps, charge may be loaded into a hole bored into the tap root at angle shown.

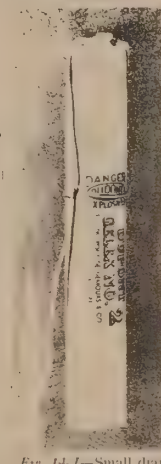

Fig. 14-J—Small diameter cartridge-primed with electric blasting cap.

Stumps in the Pacific Northwest are unusually large and heavily rooted. In most cases, therefore, work in that region will be discussed separately.

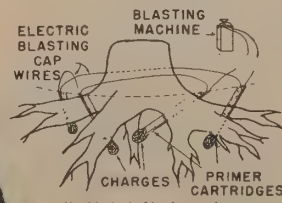

Fig. 24-H—Method of loading and connecting charges for blasting a semi-tap rooted stump.

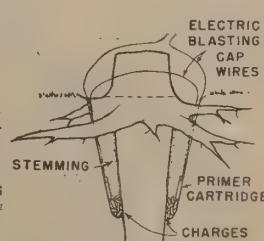

Fig. 24-J—Blasting a tap rooted stump by means of charges placed in holes dug along the root.

**Blasters' Handbook — A Manual Describing Explosives and Practical Methods of Use.** 1942... 1968; 524 pp.

\$6.00 postpaid from:

Sales Development Section Explosives Department E.I. du Pont de Nemours & Company, Inc. Wilmington, Delaware 19898

**Jensen Tools**

Electrical Tools primarily. All prices postpaid.

Jensen Catalog 65 pp.

Free

from: Jensen Tools and Alloys 3630 East Indian School Road Phoenix, Arizona 85018

**ELLIS "MAJOR" INSPECTION KIT**

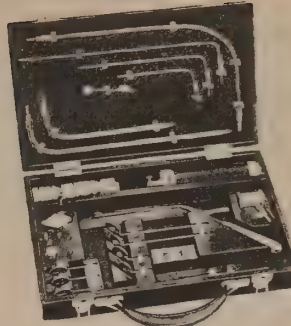

For close and accurate examination of equipment not normally accessible to the naked eye. The kit consists of a series of varying-length probes fitted with miniature electric lamps and lenses. By using these light probes and a combination of adjustable mirrors and magnifying fittings included in the kit, the most inaccessible spots may be viewed through very small apertures. Used for the inspection of waveguides (X, S, and Q bands), cavities, pumps, dies, valves, printed circuits, small motors, hydraulic systems, relays, switchboards, and electronic components (to name just a few). All parts interlocking and interchangeable. Included are the basic battery handle (complete with 2 "D" batteries), a 15" flexible probe, 5 rigid probes, 3 magnifying lenses, an adjustable mirror attachment with adapters, an automatic magnifier, an illuminated magnifier, a mirror handle, 2 long-slim mirrors, 2 magnifying mirrors, an adjustable mirror with handle, and additional lenses and bulbs. All items are mounted in a handsome wooden case as shown above.

348672 ..... \$155.00

**MODEL 355 MIDGETESTER**

So very small (2-3/4 x 4-1/2 x 1") it easily slips into your shirt pocket. No wonder the 355 Midgetester is so popular with all who must make basic voltage and resistance measurements "in the field." Features self-shielding movement and 10,000 ohms per volt sensitivity on both AC and DC ranges. Measures 0-3, 0-12, 0-60, 0-300, and 0-1200 V AC or DC. Has four resistance ranges (R x 1, R x 10, R x 100, and R x 1K). Accuracy ±3% DC and ±5% DC. Furnished complete with test leads and manual. Case available. Note: The 355 is an optional component in the JTK-16 tool kit (P. 36).

50B417 TESTER ..... \$50.00  
50B425 CASE ..... 5.50



\$18.50

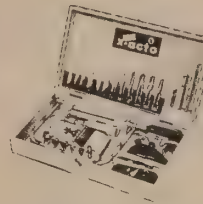

**COMPACT TOOL AND KNIFE CHEST #87**

A smaller version of the #89 deluxe kit. Contains most of the tools needed for producing wooden mockups and models. This kit includes a light-duty knife, medium-duty knife, heavy-duty knife, complete assortment of knife blades, gouges, routers, punches, plus a planer, sander, saw, spokeshave, a balsa stripper, steel rule, pin vise, screwdriver, and assorted drill bits. Packed in a fitted wood chest.

CAT. NO. 87 ..... NET EACH \$18.50

Industry & Craft 27

**Direct Use of the Sun's Energy**

The best book on Solar Energy that I know of. Any curious and intelligent person can learn a great deal about our planet and ourselves by reading this book about ways of using sunlight. There are many numbers in the book but the math never goes beyond 8th grade arithmetic. The book is clear and simple whether talking about heating water—

For general domestic use of hot water for bathing and washing dishes a temperature of 135°F (57°C) is considered adequate and 20 gal per person per day is a reasonable consumption. In many sunny climates these requirements can be met with an insulated storage tank and solar radiation absorber which has an area of 0.75 ft<sup>2</sup> gal<sup>-1</sup> of hot water. A family of four would need a tank of 80 gal and a solar absorber of 60 ft<sup>2</sup>.

**or photo chemical reactions —**

The photo dissociation of iodine (I<sub>2</sub>) molecules into atoms absorbs most of the visible light of the sun with a considerable amount of energy, but the iodine atoms recombine so fast that the energy cannot be retained. It is immediately evolved as heat during the exposure to light.

I read the book on a Greyhound bus in Texas two years ago and it has changed my life and my way of thinking.

[Reviewed by Steve Baer]

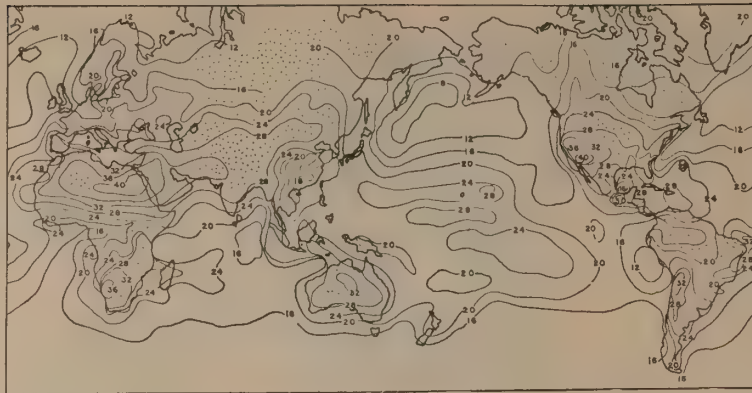

11. World wide distribution of solar energy in hundreds of hours per year. [Adapted with permission from Solar Energy, cover, 1, no. 1 (1957).]

**Direct Use of the Sun's Energy**

Farrington Daniels  
1964; 374 pp.

\$2.45 postpaid

from:  
Yale University Press  
149 York Street  
New Haven, Conn. 06511  
or  
WHOLE EARTH CATALOG

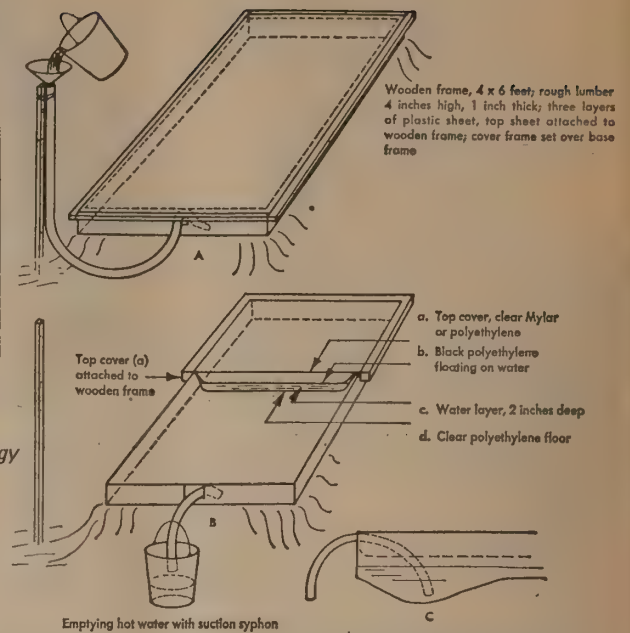

29. Inexpensive solar water heater. A. Filling with cold water. B. Emptying hot water with suction syphon. C. Side view, showing position of end of hose.

29 Industry & Craft

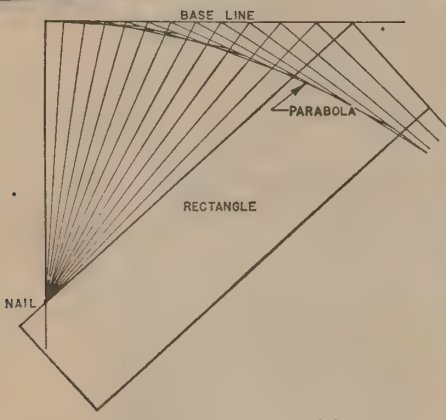

18. Method for drawing a parabola.

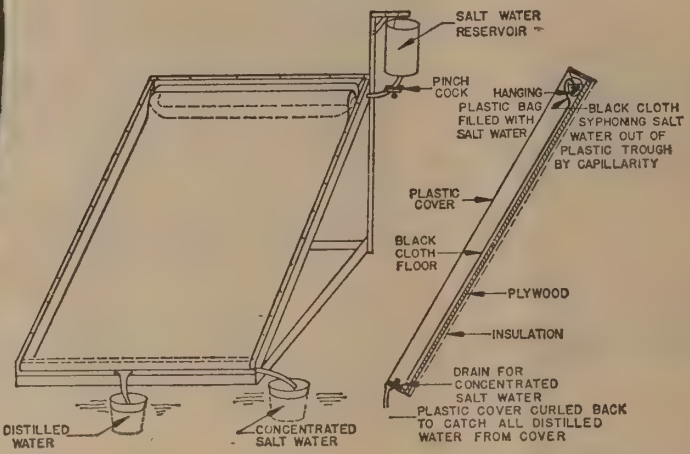
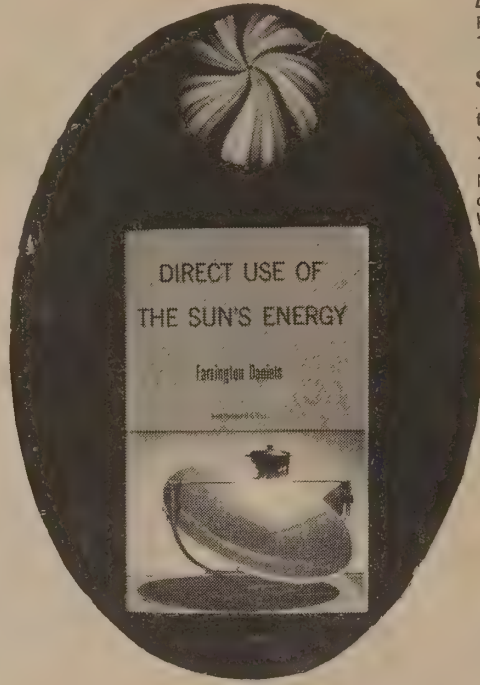

32. Tilted plastic still of simple construction.

**Structure, Form and Movement**

The usual procedure is that R&D comes up with a new process, it's implemented for several years, and then some biologist says Hey did you know porpoises did that? (or snakes did that, or bees or elm seeds). And everybody says My, my, ain't Nature smart.

Herr Hertel and colleagues is trying to reverse the order, learn from nature first, save time and stay humble. (This approach now has a name, "bionics"; a book by that title that's around is terrible.)

This book may be too expensive for its direct usefulness, but it thoroughly displays the approach that research may take to bugs, birds, fish, etc. for yield in navigation, flight, streamlining, etc.

**Structure, Form and Movement**

Heinrich Hertel from:  
1963, 1966; 251 pp. Reinhold Publishing Company  
430 Park Avenue  
New York, N.Y. 10022

\$17.50 postpaid

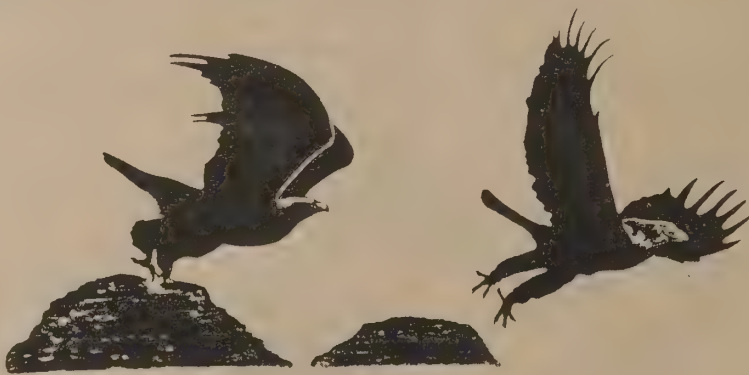

Golden eagle. Leaping off. Legs flexed at left, extended at right

The hand remiges of birds are masterfully perfected to obviate flutter:

- The hollow cross section of the supporting frame consisting of the feather quill is continuous over the entire length and approximates a cylinder, which resists torsion well. This cross section also improves resistance to bending.
- The ultralight construction of the vanes ensures minimum moment of mass about the quill axis.
- Variations in aerodynamic forces during oscillation affect 25% of the profile depth. Consequently, the form of the remiges, with narrower anterior vane sections and broader posterior vane sections, is appropriate for aeroelastic reasons. In the primary feather shown in figure 65, the resultant of aerodynamic forces lies behind the shaft.
- With this aerodynamically desirable arrangement it is impossible to locate the resultants of mass distribution ahead of the torsion axis.
- The arrangement of the three axes (in order from front to back: torsion axis, centroidal axis, aerodynamic axis) is thoroughly favorable for achieving a high critical velocity.
- Considerable damping of the oscillation system is provided by the foam filling (support of the coverts).

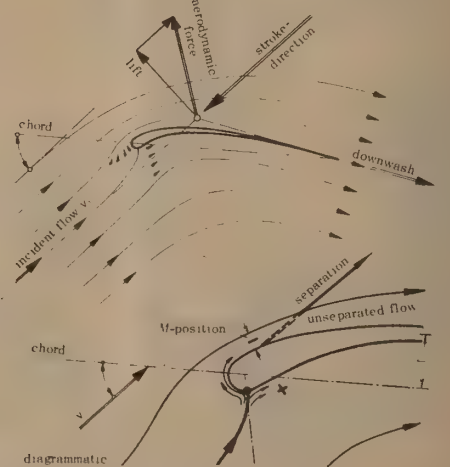

Fig. 52 Beginning of take-off = wing stroke forward and down  
Incident flow - downwash - forces.  
Below: stagnation point; flow around the leading edge.

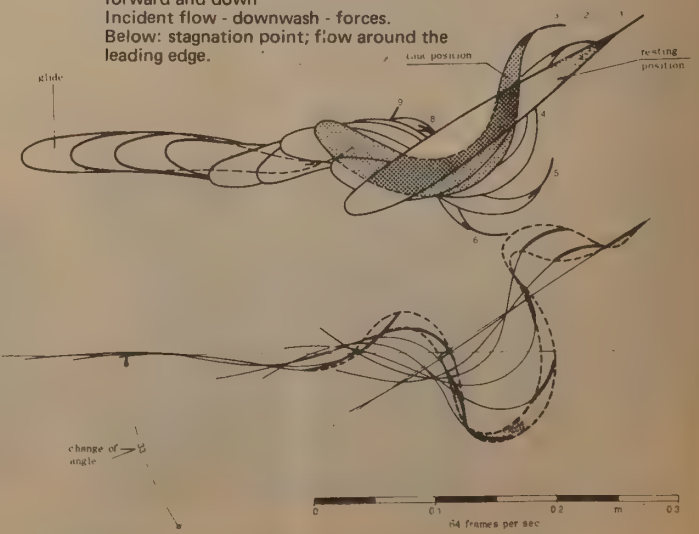

Fig. 204 Starting thrust-lunging of trout (Salmo gairdneri) Top: progress of movement according to motion picture record. Bottom: fin stroke.

**Van Waters & Rogers**

A few years back, when I needed to make a darkroom sink, Jerry Stoll told me about miraculous substance unaffected by wet, heat or chemicals that could be painted on plywood. So I got some clear Carboline paint at Van Waters & Rogers and it worked (still does): plain old plywood doesn't leak, crack, peel, or corrode. Now I'm thinking about a wood bath tub.

Van Waters & Rogers is a huge lab supply house. I don't know anything about them except they have a hard-bound catalog this thick full of illegal-looking equipment. They have outlets all over the western U.S.

Van Waters & Rogers Catalog  
1112 pp.



Free if you justify your existence as a customer.

from:  
Van Waters & Rogers  
P.O. Box 3200  
Rincon Annex  
San Francisco, California 94119

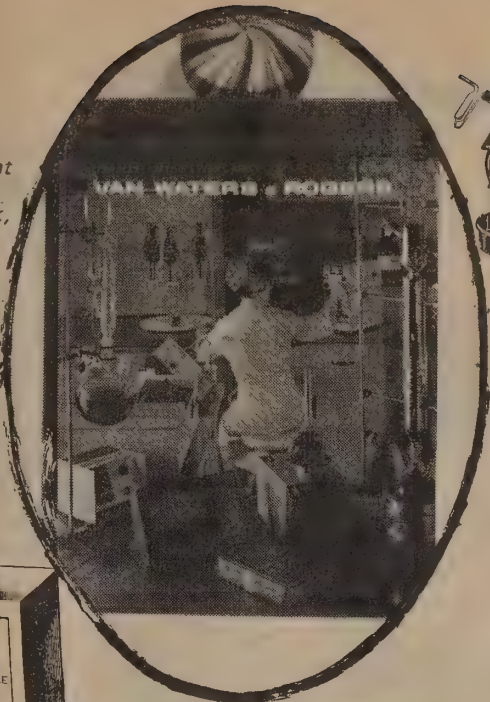

**PAINT, Corrosion-Resistant, Plastic, Self-Priming, Carboline, Series "K"** — Provides excellent protection indoors and out against corrosive fumes, corrosive atmospheric conditions, occasional spillage of acids or alkalis. Particularly useful in the chemical, petroleum, laundry, food, beverage and similar industries. Long-lasting and economical. Simple to apply — requires no special surface preparation, and no primer, intermediate or seal coat. Stands up well under most acids and alkalis, oils, greases and alcohols. Excellent moisture resistance. Can be applied equally well to metal, concrete or wood. Brushes or sprays on.

52673-081	Black	Quart	2.45
52673-128	Clear	Quart	2.45
52673-161	Gray	Quart	2.85
52673-285	White	Quart	3.00
52674-084	Black	Gallon	6.70
52674-120	Clear	Gallon	6.70
52674-164	Gray	Gallon	8.00
52674-288	White	Gallon	8.45

**THINNER** — For use, only if necessary, in brush application, to make brushing easier. For use with Nos. 52673-081 — 52674-288. For spraying, one part of Carboline thinner to two parts of Carboline paint.

52675-043	Quart	1.65
52675-087	Gallon	4.35



Benzene

**CORROSION-RESISTANT LABORATORY PAINTS**



52673-081 — 52675-087

**Bookmaking**



A textbook for book designers.

Should enable anyone from author to customer to communicate intelligently about any aspect of the design or production of a book. Probably the only existing reference for someone who needs to deal with printers and publishers, and isn't quite sure he knows an offset from a castoff. Perhaps the best thing that can be said about this book is that it is beautifully designed, but by the time you finish reading it you'll probably know enough to start criticizing its design.

[Reviewed by Larry McCombs]

To reconcile the sometimes divergent needs of the various aspects of bookmaking, decide first on what should be done creatively, then modify these decisions as necessary to accommodate the practical considerations. In other words, plan the ideal first and retain as much of it as you can. This works better than any other procedure because the creative process functions best when it is free of practical considerations. The moment you accept mechanical or economic limitations, your imagination tends to freeze. Not that it merely restricts itself to the practicable—it tends to act as though the limiting walls were made of glass, and it swings in a cramped arc far short of those walls. This is a safe enough procedure, but it precludes any chance of extending the possible.

Bookmaking  
Marshall Lee  
1965; 399 pp.

\$12.75 postpaid

from:  
R. R. Bowker Company  
1180 Avenue of the Americas  
New York, N.Y. 10036

The readability of a page is affected by no less than 9 factors:

- (a) typeface,
- (b) size of type,
- (c) length of line,
- (d) leading,
- (e) page pattern (which includes "margins"),
- (f) contrast of type and paper (which includes color),
- (g) texture of paper,
- (h) typographic relationships (heads, folios, etc.), and
- (i) suitability to content.

**PROOFREADERS' MARKS**

Marginal sign	Mark in text	Meaning	Corrected text
3	Proofreading	Delete, take out letter or word	Proofreading
(e)	Legibility is the requirement of a proofreader's marks.	Delete and close up	Legibility is the first requirement of a proofreader's marks.
first		Insert marginal addition	
( )		Close up entirely	
—	Symbols should be made neatly and	Less space	Symbols should be made neatly and
⌋		Push space down to avoid printing	
#	in line with the text to which they refer. Place marks carefully.	Add space	in line with the text to which they refer.
eq. #		Space evenly	
¶		New paragraph	Place marks carefully. Paragraphs may be
no ¶		No new paragraph	



Industry & Craft 29



**Zone System Manual**

This invisible book contains the essence of Ansel Adams' zone system of photography distilled by Minor White, who has his own mastery. The term for the process is previsualization, which is looking at reality through an accurately imagined photographic print, then knowing how to make the calculations and mechanical and chemical adjustments so that the print has what you saw. It's all here.

**ZONE**

a "Zone" as a visual unit of measurement is arrived at by altering a standard exposure by one "stop" more or one "stop" less. For example all the values in a scene exposed at f/11 at 1/25 second would print one "zone" lighter than a print of the same scene exposed at f/16 at 1/25 second. (Providing

of course that the two negatives were given identical development time and the same exposure time in the enlarger.)

This "one Stop" or "one Zone" alteration, links the "zone" to the classic 1:2 exposure ratio used in photography to calibrate shutter speeds and diaphragm openings or "stops."

EXTEND PREVISUALIZATION UNTIL THE NEGATIVE IMAGE BELOW CAN BE SEEN IN YOUR OWN EYE

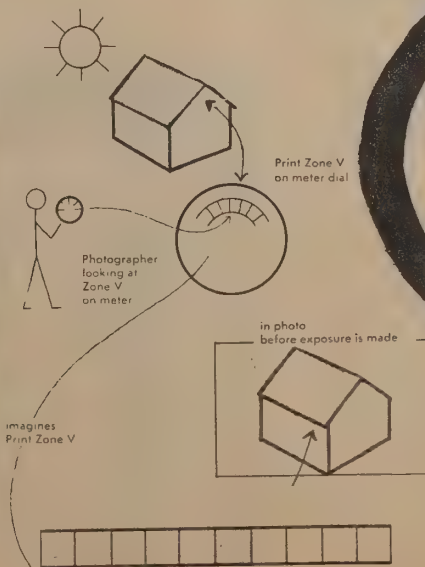

THE 1st STAGE IN PREVISUALIZATION

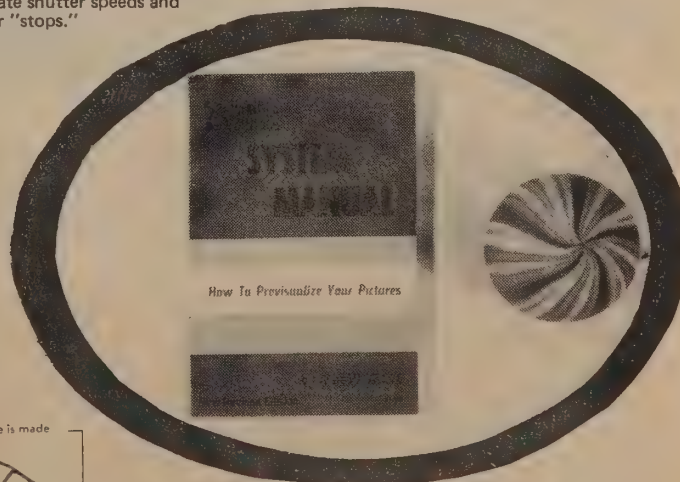

Zone System Manual  
Minor White  
1965; 112 pp.

\$1.95 postpaid

from:  
Morgan & Morgan, Inc.  
25 Main Street  
Hastings-on-Hudson, N.Y. 10706  
or  
WHOLE EARTH CATALOG

## A Sculptor's Manual

This book is a well organized presentation of the basic processes behind sculpture. Detailed processes are made to seem simple, but not oversimplified; it remains obvious that a good deal of patience will be required to cast a bronze by the lost wax method. People who do not know what technique will suit them best and who want a solid footing from which to experiment, will find *A Sculptor's Manual* most useful. It encourages you to attempt the forms you have imagined, by showing you how.

The nine chapters cover plaster usage; foundry practice; flame and electric welding; plastics; cement; stone and wood; repetition casting; general construction; finishing; and surface coatings. Cross referencing, a glossary, and 27 diagrams make the book all the more usable. British sculptors will find a buyer's guide at the end of each chapter. Americans are referred to the yellow pages, Bernard Klein's "Guide to American Directories" and the "Thomas Register" (see p. 23 of the CATALOG) to find sources for materials.

At the back of the book is a section of 22 photos of finished sculpture, just enough to intrigue and egg you on without being pushy.

[Reviewed by Joe Bonner]



*A Sculptor's Manual*  
Geoffrey Clarke & Stroud Cornock  
1968; 158 pp.

\$8.50 postpaid

from:  
Reinhold Publishing Company  
430 Park Ave.  
New York, N.Y. 10022

temperature at which it was formed and it will revert through the sequence of forming operations back into a sheet.

Thermosets are built up with glass-fibre reinforcement over female mould surfaces and subsequently painted if required, though mass-pigmentation can be effected before lay-up.

Thermoplastics can be bent and formed when hot, either freely or by mechanical forming, e.g. they can be injected under pressure into moulds. These materials can be bonded with adhesives, welded together by high-frequency vibration, screwed over a frame or welded with hot gas and a filter rod. It is possible to vary the mass-pigmentation of various thermoplastics by laminating a screen-printed surface onto the rigid sheet.

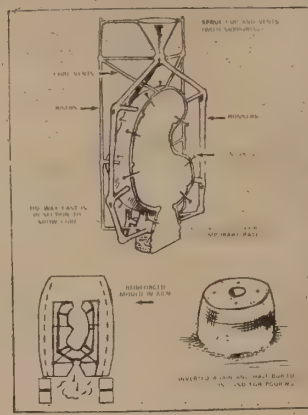

Eduardo Paolozzi Hagim 1967  
Chrome-plated steel. 2½ in. by 11¾ in. by 6 in.  
Hanover Gallery, London photo: Howards Studio

Lost Wax process or cire perdue.

A lengthy and complex process. Join all wax runners, risers, etc., with a wax knuckle by modelling with a hot spatula. Reinforce grog with chicken wire. Before removal from kiln, reinforce surface with plaster and scrim. Keep sprue clear of sand, etc.

The process has changed little since the Greeks brought it to a pitch of achievement, and it is still so demanding that very few foundries exist. Their services are very costly. If you have a sculpture in clay, wax or plaster, and it is of a nature that demands faithful reproduction, there is no doubt that bronze—far denser than aluminium, cast by the Lost-Wax process—quite different from sand-casting—presents the only method of preserving the form and texture accurately.

This is an extremely complex and variable method, though large works can be cast more cheaply if it is followed up to the point at which the wax has been cored—or just to the production of the wax (without runners or core)—and the result is then given to a foundry for casting. If the foundrymen produce a bad result, however—it will be your fault.

## 30 Industry & Craft

Does any reader know of a thorough book—up to date—on the techniques of working with plastics?

The development of plastics has been continuing since the end of the last century and the term plastics now covers a complex of materials of which those dealt with here form a small and relatively simple part.

Firstly, there is the vast range of thermosetting plastics materials which are manufactured as liquids in two or three component parts. These are the polyesters and epoxy resins. They require reinforcement and are formed in a one-way process.

Secondly, there is an even larger range of thermoplastics, manufactured in powder or chip form and fabricated into very thin sheets which are subsequently laminated to provide whatever thicknesses may be required. They are structural materials—either flexible or rigid—and are formed under heat in a reversible process: raise a thermoplastic object carefully to the

## Creative Glass Blowing

This well-illustrated and carefully written book begins with the statement "Any one can learn to blow glass." To a large extent, the authors, one of whom is a professional glass blower, succeed in making that statement believable. However, the first 50 pages are concerned with the tools of the glass blower and I found myself wondering, "Yes, but can anyone learn to be a pipe-fitter, metal worker, carpenter, and electrician?" If you can do those things, there is little doubt that this book (and several hundred dollars worth of tools and related supplies) will enable you to blow glass—probably creatively.

Don't expect to take up glass blowing casually, with just this book, but if it is a hobby to which you can commit yourself seriously this book would be an excellent investment, for starters.

There is a page at the end that lists sources of tools and materials. Unfortunately, there are only a few suppliers mentioned, all of whom are in the East. Alas, we westerners need a special supplement, obviously.

[Reviewed by Richard Raymond]

*Creative Glass Blowing*  
James E. Hammesfahr, Clair L. Stong  
1968; 196 pp.

\$8.00 postpaid

from:  
W.H. Freeman & Company  
660 Market Street  
San Francisco, Ca 94104  
or  
WHOLE EARTH CATALOG

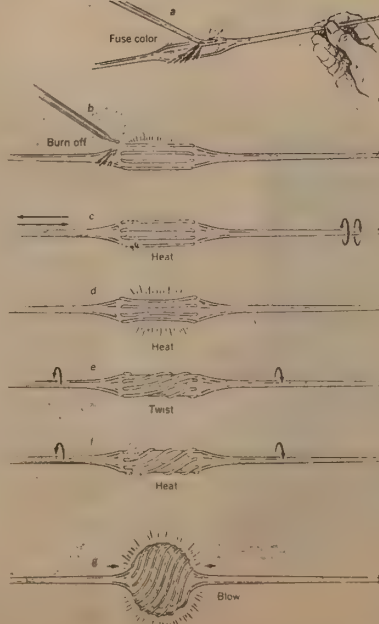
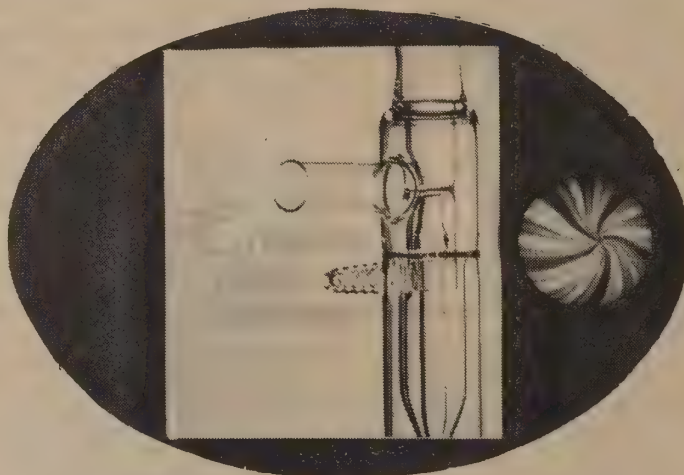

Here, then, is the first skill you must develop in the course of becoming a glass blower: the knack of rotating hot glass at a rate that precisely counteracts the force of gravity. The trick is not difficult to master if you follow a few simple rules. First, never soften more glass than you need for making a desired form. If you intend to impart a rounded shape to the end of a rod, heat only the tip. Second, never soften the material more than necessary to accomplish your objective. Obviously, stiff glass is easier to control than runny glass. Watch the work as it softens and changes form. Alter its position in the fire to take advantage of gravity, or to offset the effect of gravity, as the case may be. This is accomplished by rotating the work.

Figure 4-35.



**Buckskin**

*This is one of the best deals in the CATALOG. Buckskin in downtown San Francisco costs \$1.50 a square foot; Leather Tanning offers the same material for 90¢/sq.ft. postpaid anywhere in the U.S. The buckskin is chrome-tanned, which makes it more resistant to the effects of water than oil-tanned skin. The company also carries cowhide, elk skin, hair-on calf, etc. Orders for a dozen or more skins get 10¢/sq.ft. discount. Buckskins are generally 10-12 sq.ft. in size, calf skins smaller, elk skins larger. The shirt was made of two 12 sq.ft. buckskins.*

**Buckskin**

Buckskin  
**\$ .90** /sq.ft. postpaid

Hair-on-calf (clipped)  
**\$ 1.80** /sq.ft. postpaid

Hair-on-calf (unclipped)  
**\$ 1.60** /sq.ft. postpaid

from:  
 Leather Tanning Company  
 P.O. Box 2406a  
 San Francisco, California 94124



Buckskin



Hair-on calf (unclipped)

**Melrose Yarns**

*Of the mail-order yarn catalogs that we've seen, this is the most complete, least expensive. Prices are comparable to or better than most yarn stores.*

**Melrose Yarns**

Catalog and Sample Card  
**\$ .50**

from:  
 Melrose Yarn Company, Inc.  
 1305 Utica Avenue  
 Brooklyn, New York 11203



**Cut Beads**

*In evaluating Indian beadwork, one of the first things you notice is whether the beads are cut or seed beads. Cut beads are slightly faceted so they reflect a scattered sparkling of light from the beadwork. They raise the value of the piece because (1) it is prettier, (2) the craftsman went to the extra trouble or expense to get cut beads, (3) the piece may be antique.*

*The single source of cut beads in America is Elliot Greene & Co. in New York. They sell a minimum of 1/2 kilo per color. Coax your bead pusher to stock up.*

[Suggested by Michael Hoffman]

**Cut Beads**

**\$12.50** per 1/2 kilo

from:  
 Elliot Greene & Company, Inc.  
 37 West 37th Street  
 New York, N.Y. 10018

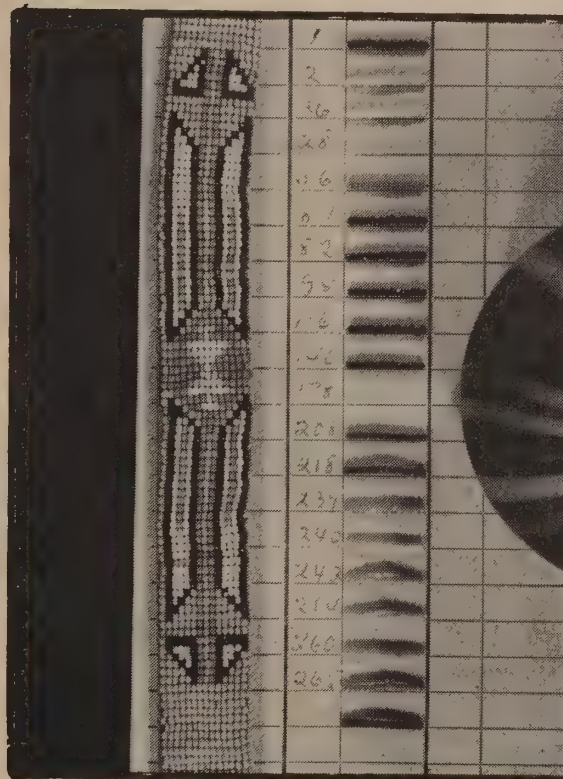

## Human Biocomputer

John Lilly has worked for a long time with sensory deprivation, pursuing the notion that relieving the computer (mind) of many of its environmental-survival chores frees it to attend more fully to self-investigation. Of late he's added LSD to the process and has found ways to flourish and discover within this doubly floating condition.

The paper *Human Biocomputer* is the best internal guidebook I've seen—far more practical and generalized than transcendent Eastern writings or wishful Underground notes. Though it's not the whole story by any means, it makes an open start on fresh language and powerful technique for the frontier.

An additional advantage the paper offers is the opportunity to learn and explore computers without requiring money or administrative approval. You inherited and grew everything you need, and it's free.

[Suggested by Ralph Metzner]

For example, the term 'reprogramming substances' may be appropriate for compounds like lysergic acid diethylamide. For substances like ethyl alcohol the term 'metaprogram-attenuating substances' may be useful.

I believe that by using certain methods and means some of which are presented in this work that truly talented and dedicated individuals can forge, find, and devise new ways of looking at our minds, ways which are truly scientific, intellectually economical, and interactively creative. Consider for example, the case of the fictitious individual created by the group of mathematicians masquerading under the name of "Dr. Nicholas Bourbaki."

This group of mathematicians in order to create a mathematics or sets of mathematics beyond the capacity of any one individual, held meetings three times a year and exchanged ideas, then went off and worked separately. The resulting papers were published under a pseudonym because the products of this work were felt to be a group result beyond any one individual's contribution.

The major problems of the research of interest to the author center on the erasability, modifiability, and creatibility of programs. In other words, I am interested in the processes of finding metaprograms (and methods and substances) which control, change, and create the basic metaprograms of the human computer. It is not known whether one can really erase any program.

The boundary of the brain, of course, may be considered as the limits of the extensions of the central nervous system into the periphery.

In the maximally attenuated environment (92 to 95 degrees F. isothermal skin, saltwater suspension, zero light levels, near-zero sound levels, without clothes, without wall or floor contacts, in solitude in remote isolation, for several hours), the addition of LSD-25 allows one to see that all the previous experiences with 'outside screens' are evasions of deeper penetration of self (and hence are "screens" in the sense of 'blocking the view behind,' as well as 'receiving the projected images').

Later with higher motivational energy the subject returned to the problem of the lock, the doors and the rooms somewhat refreshed by the experiences in the other realms.

The essential features and the goals sought in the self-analysis is the metaprogram "make the computer general purpose". In this sense we mean that in the general purpose nature of the computer there can be no display, no acting, or no ideal which is forbidden to a consciously willed program. Nor is any display, acting, or ideal made without being consciously programmed.

"Mathematical transformations" were next tried in the approach to the locked rooms. The concept of the key fitting into the lock and the necessity of finding the key was abandoned and the rooms were approached as "topological puzzles." In the multidimensional cognitional and visual space the rooms were now manipulated without the necessity of the key in the lock.

## Human Biocomputer

John C. Lilly, M.D.  
1967; 160 pp.

Inquire for price (Metzner says its about \$5.00) from:

Communications Research Institute  
Miami, Florida 33133



## HUMAN BIOCOMPUTER

JOHN C. LILLY, M.D.  
1967

COMMUNICATION RESEARCH INSTITUTE  
MIAMI - FLORIDA 33133

## 32 Communications

### The Mind of the Dolphin

Lilly knows that it is to everybody's advantage for one kind of computer to link up with another, and that's his program with dolphins. This book reports his speculations and experiments with dolphins in recent years. Included is a thorough account by a girl, Margaret Howe, who lived alone with Peter Dolphin for 10 weeks. As usual with research on communication, everything discovered has broad implications.

Sometimes I feel that if man could become more involved in some problems of an alien species, he may become less involved with his own egocentric pursuits, and deadly competition within his species, and become somehow a better being.

We are often asked, "If the dolphins are so intelligent why aren't they ruling the world?" My very considered answer to this is—they may be too wise to try to rule the world. The question can be easily turned around, Why does man or individual men want to rule the world? I feel that it is a very insecure position to want to rule all of the other species and the vast resources of our planet. This means a deep insecurity with the "universes" inside of one's self. One's fears and one's angers are being projected on others outside of one's self; to rule the world is, finally, to rule one's inner realities.

Thus a given dolphin can carry on a whistle conversation with his right side and a clicking conversation with his left side and do the two quite independently with the two halves of his brain.

Conservatively, we estimate that the dolphin can put out ten times the sonic physical information per second that a man produces.

The information does not exist as information until it is within the higher levels of abstraction of each of the minds and computed as such. Up to the point at which it becomes perceived as information, it is signals. These signals travel through the external reality between the two bodies, and travel as signals within the brain substances themselves. Till the complex patterns of traveling neuronal impulses in the brain are computed as information within the cerebral cortex, they are not yet information. Information is the result of a long series of computations based on data signal inputs, data signal transmissions to the brain substance, and recomputations of these data.



### The Mind of the Dolphin

John Cunningham Lilly, M.D.  
1967; 310 pp.

\$5.95 postpaid

from:

Doubleday & Company, Inc.  
501 Franklin Avenue  
Garden City, L.I., N.Y. 11531  
or  
WHOLE EARTH CATALOG

By long and hard work I found that the evil label "negative" should not be tied to any mode or any kind of thinking at all.

I found that bodily sources of discomfort, pain, or threat tend to program the mind in the negative mode and keep it there as long as the discomfort continues. As long as pain, even at a very low level, continues, the computer (which is one's mind) tends to program a negative pall.

Once one has been through deep experiences in tune with the vast forces of the universe, the vast forces within ourselves, we see that the need for conflict, the need for hostility, and the need for hatred become less intense. One finds the universe inside and the one outside so vast and so lonely that any other living thing that loves or shows any signs of loving is precious and close.

The human participant's assumptions, i.e., those of Margaret C. Howe, in her own words are as follows:

1. Dolphins are capable of communication with man on the level of high intelligence.
2. Dolphins are not only capable of this communication but are eager for it and are willing to cooperate with man to achieve it.
3. Possibly the best way to go about establishing this communication is to set up a situation where the man (woman) and a dolphin live together as closely as possible for an extended period of time.
4. This is a long process and involves many steps, each of which must be recognized and encouraged. The attempt to communicate with a dolphin in English involves two main parts: (1) the dolphin must learn how to physically say the words, and (2) he must learn the meaning of what he is saying. These two parts may be worked out individually or simultaneously.
5. One first step is the creation and the maintenance of the mutual trust and reciprocal rewards one for the other.

Figure 1. Schema of the Levels of the Functional Organization of the Human Biocomputer

Each part of each level has feedback-control relations with each other part, indicated by the connecting lines. Each level has feedback-control with each other level. For the sake of schematic simplicity, many of these feedback connections are not shown. One example is an important connection between Levels VI and X; some built-in, survival programs have a representation at the Metaprogram Level which places a representative at the Supra-self-metaprogram Level as follows: "These programs are necessary for survival; do not attenuate or excite them to extreme values; such extremes lead to non-computed actions, penalties, illness, or death." After construction, such a Metaprogram is transferred by the Self-metaprogram to the Supra-self-metaprogram for future control purposes.

The boundaries between the body and the external reality are between Levels I and II; certain energies and materials pass this boundary in special places (heat, light, sound, food, secretions, feces). Boundaries between body and brain are between Levels II and III; special structures pass this boundary (blood vessels, nerve fibers, cerebro-spinal fluid). Levels IV through X are in the brain circuitry and are the software of the Biocomputer.

Levels above Level X are labeled "Unknown" for the following purposes: (1) to maintain the openness of the system, (2) to motivate future scientific research, (3) to emphasize the necessity for unknown factors at all levels, (4) to point out the heuristic nature of this schema, (5) to emphasize unwillingness to subscribe to any dogmatic belief without testable hard-nosed reproducible data, and (6) to encourage creative courageous imaginative investigation of unknown influences on and in human internal realities.

In the analysis of the effects of LSD-25 on the human mind, reasonable hypothesis states that the effect of these substances on the human computer is to introduce "white noise" (in the sense of randomly varying energy containing no signals of itself) in specific systems in the computer . . . . .

The increase in "white noise" energy allows quick and random access to memory and lowers the threshold to unconscious memories ("expansion of consciousness"). In such noise one can project almost anything at almost any cognitive level in almost any allowable mode...

The noise introduced brings a certain amount of disorder with it, even as white noise in the physical world brings randomness. However, the LSD-25 noise randomizes signals only in a limited way: not enough to destroy all order, only enough to superimpose a small creative 'jiggling' on program materials and metaprograms and their signals.

In the complete physical absence of other external computers within the critical interlock distance, the self-directed and other-directed programs can be clearly detected, analysed, recomputed, re-programmed, and new metaprograms initiated by the solitudinous computer itself. In the as-completely-as-possible-attenuated-physical-reality environment in solitude, a maximum intensity, a maximum complexity and a maximum speed of re-programming is achievable by the self.

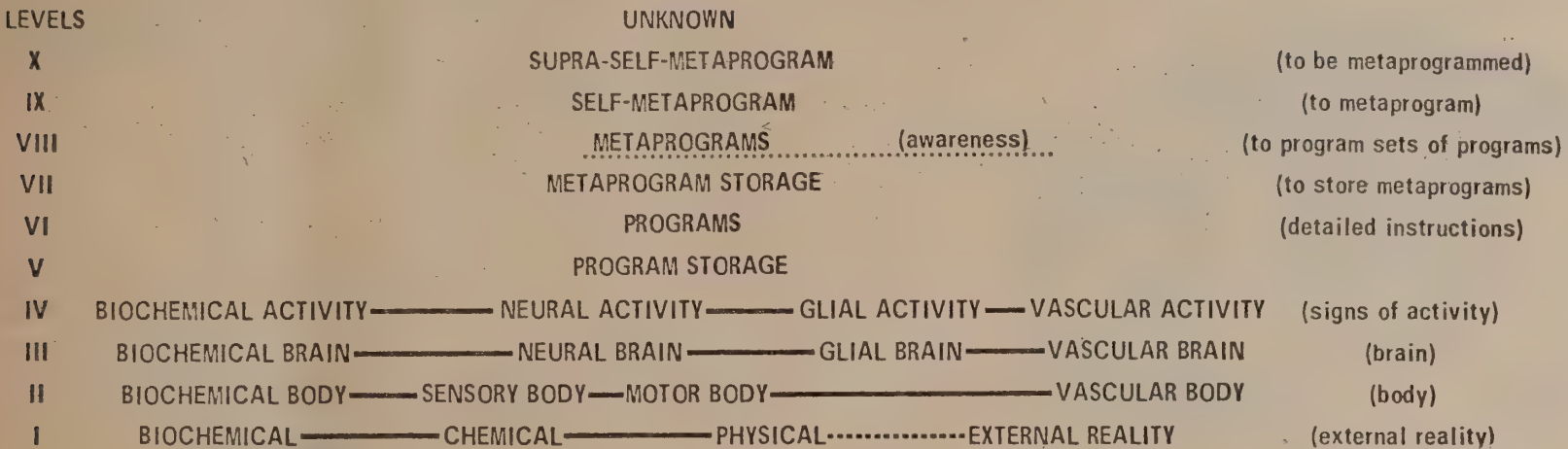

John C. Lilly, M.D., Human Biocomputer: Programming and Metaprogramming. Miami: Communication Research Institute, 1967; Scientific Report No. CRI 0167

Information

The September 1966 issue of *Scientific American* was devoted entirely to the new technology of information. Now available as a paperbound book, it is the best introduction we've seen to computer science. Articles include: "Computer Logic and Memory", "Computer Inputs and Outputs", "Systems Analysis and Programming", "Time-sharing on Computers", "The Transmission of Computer Data", "The Uses of Computers in Technology", "The Uses of Computers in Organizations", "The Uses of Computers in Education", "Information Storage and Retrieval", and "Artificial Intelligence".



Information  
1966; 218 pp.  
\$2.50 postpaid

from:  
W.H. Freeman & Company  
660 Market Street  
San Francisco, California 94104  
or  
WHOLE EARTH CATALOG

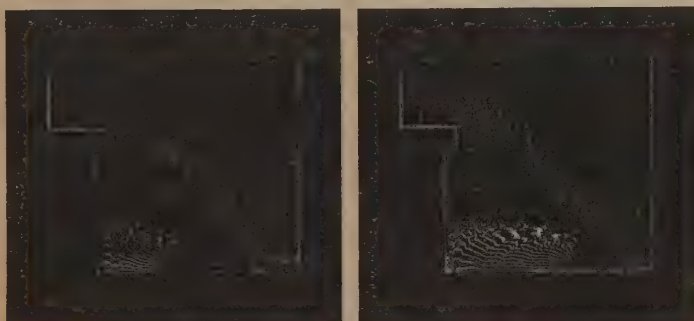
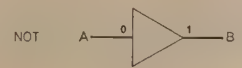
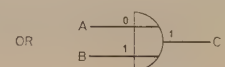
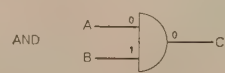
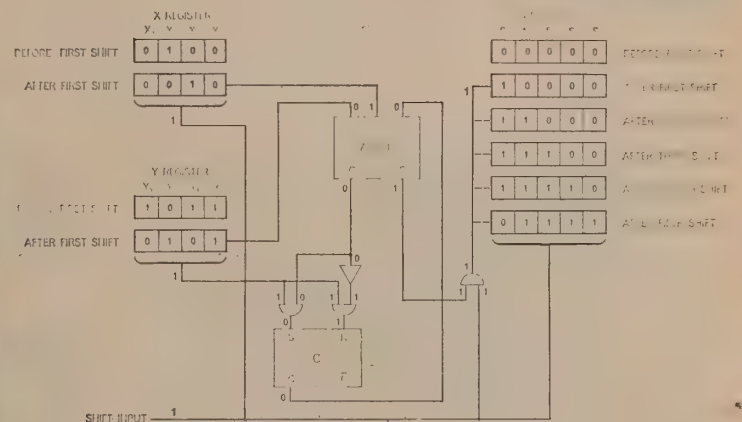

10. Simulated waterfall spills over the edge of a cliff and splashes into a pool in this computer experiment performed by John P. Shannon at the Los Alamos Scientific Laboratory as part of a study of dynamic behavior of fluids with the aid of numerical models.

## 9100A Calculator

The best of the new table-top number crunchers is this Hewlett-Packard machine. It is programmable, versatile, and silent—more so than its competition. Portola Institute currently is using the 9100A to help kids gain early mastery over computers—it is a superb inquiry machine.

Specs: 9100A can do addition, subtraction, multiplication, division, square root,  $\log x$ ,  $\ln x$ ,  $e^x$ ,  $\sin x$ ,  $\cos x$ ,  $\tan x$ ,  $\sin^{-1}x$ ,  $\cos^{-1}x$ ,  $\tan^{-1}x$ ,  $\sinh x$ ,  $\cosh x$ ,  $\tanh x$ ,  $\sinh^{-1}x$ ,  $\cosh^{-1}x$ ,  $\tanh^{-1}x$ , polar to rectangular and vice versa co-ordinate transformations. Number range is  $10^{-99}$  to  $10^{99}$ . The magnetic core memory has 19 registers: 3 display and 16 storage. Display is decimal or floating point. Program capacity is 196 steps. Programming is done by pressing keys in proper sequence (no special language required). Programs may be stored on wallet sized magnetic cards. Typical operations take 2-280 milliseconds. Weight of the machine is 40 lbs, dimensions 8"x16"x19" deep. Reportedly the following accessories will be available soon: printer, xy plotter, input/output interface.

[Suggested by Robert Albrecht]



Hewlett-Packard Model 9100A Calculator keyboard and display. Hypertonic, trigonometric and coordinate transformations, functions, and trigonometric functions, etc. Display is decimal.



HP 9100A

\$4900.00 65 lbs shipping weight

from:  
P.O. Box 301  
Loveland, Colorado 80537

## 34 Communications

### Cybernetics

McLuhan's assertion that computers constitute an extension of the human nervous system is an accurate historical statement. The research and speculation that led to computer design arose from investigation of healthy and pathological human response patterns embodied in the topological make-up of the nervous system. Insights here soon expanded into generalizations about communication that permitted the building of analogous electronic devices physically separate from the Central Nervous System. But they're just one artifact of these new understandings about communication. Society, from organism to community to civilization to universe, is the domain of cybernetics. Norbert Wiener has the story, and to some extent, is the story.

To predict the future of a curve is to carry out a certain operation on its past.

The central nervous system no longer appears as a self-contained organ, receiving inputs from the senses and discharging into the muscles. On the contrary, some of its most characteristic activities are explicable only as circular processes, emerging from the nervous system into the muscles, and re-entering the nervous system through the sense organs, whether they be proprioceptors or organs of the special senses. This seemed to us to mark a new step in the study of that part of neurophysiology which concerns not solely the elementary processes of nerves and synapses but the performance of the nervous system as an integrated whole.

The feedback of voluntary activity is of this nature. We do not will the motions of certain muscles, and indeed we generally do not know which muscles are to be moved to accomplish a given task; we will, say, to pick up a cigarette. Our motion is regulated by some measure of the amount by which it has not yet been accomplished.

I have spoken of the race. This is really too broad a term for the scope of most communal information. Properly speaking, the community extends only so far as there extends an effectual

transmission of information. It is possible to give a sort of measure to this by comparing the number of decisions entering a group from outside with the number of decisions made in the group. We can thus measure the autonomy of the group. A measure of the effective size of a group is given by the size which it must have to have achieved a certain stated degree of autonomy.

Thus small, closely knit communities have a very considerable measure of homeostasis; and this, whether they are highly literate communities in a civilized country or villages of primitive savages. Strange and even repugnant as the customs of many barbarians may seem to us, they generally have a very definite homeostatic value, which it is part of the function of anthropologists to interpret. It is only in the large community, where the Lords of Things as They Are protect themselves from hunger by wealth, from public opinion by privacy and anonymity, from private criticism by the laws of libel and the possession of the means of communication, that ruthlessness can reach its most sublime levels. Of all of these anti-homeostatic factors in society, the control of the means of communication is the most effective and most important.

The mongoose begins with a feint, which provokes the snake to strike. The mongoose dodges and makes another such feint, so that we have a rhythmical pattern of activity on the part of the two animals. However, this dance is not static but develops progressively. As it goes on, the feints of the mongoose come earlier and earlier in phase with respect to the darts of the cobra, until finally the mongoose attacks when the cobra is extended and not in a position to move rapidly. This time the mongoose's attack is not a feint but a deadly accurate bite through the cobra's brain.

In other words, the snake's pattern of action is confined to single darts, each one for itself, while the pattern of the mongoose's action involves an appreciable, if not very long, segment of the whole past of the fight. To this extent the mongoose acts like a learning machine, and the real deadliness of its attack is dependent on a much more highly organized nervous system.

To use a biological analogy, the parallel system had a better homeostasis than the series system and therefore survived, while the series system eliminated itself by natural selection.

We thus see that a non-linear interaction causing the attraction of frequency can generate a self-organizing system.....

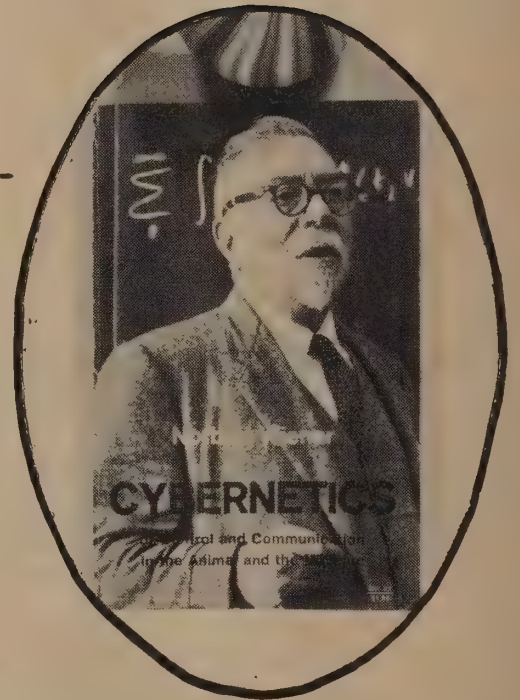

Cybernetics — or Control and Communication in the Animal and the Machine

Norbert Wiener  
1948, 1961; 212 pp.

\$1.95 postpaid

from:  
The M.I.T. Press  
Cambridge, Mass. 02142  
or  
WHOLE EARTH CATALOG

**Eye and Brain**

I can't think of another book as well-made as this one. It is well designed, illustrated, and diagrammed. The writing is excellent, the subject matter important and new. The book is inexpensive. Altogether *Eye and Brain* lets you see how crappy most books are.

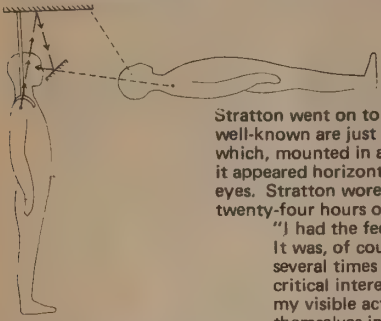

Stratton went on to perform other experiments which though less well-known are just as interesting. He devised a mirror arrangement which, mounted in a harness, visually displaced his own body, so that it appeared horizontally in front of him, and at the height of his own eyes. Stratton wore this mirror arrangement for three days (about twenty-four hours of vision) and he reported:

"I had the feeling that I was mentally outside my own body. It was, of course, but a passing impression, but it came several times and was vivid while it lasted. . . But the moment critical interest arose, the simplicity of the state was gone, and my visible actions were accompanied by a kind of wraith of themselves in the older visual terms.

Why should the perceptual system be as active in seeking alternative solutions as we see it to be in ambiguous situations? Indeed it seems more active, and more intellectually honest in refusing to stick with one of many possible solutions, than in the cerebral cortex as a whole—if we may judge by the tenacity of irrational belief in politics or religion. The perceptual system has been of biological significance for far longer than the calculating intellect. The regions of the cerebral cortex concerned with thought are comparatively juvenile. They are self-opinionated by comparison with the ancient striate area responsible for vision.

Held found that only the active kitten developed perception, the passive animal remaining effectively blind. He thus suggested that active touch is essential to perceptual development.

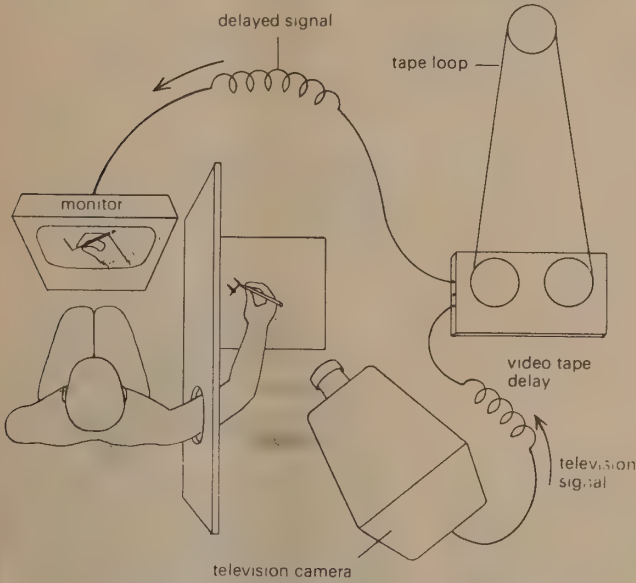

An elaboration of the television technique makes it possible to displace retinal images not only in space, but in time. Temporal delay of images is a new kind of displacement, and promises to be of the greatest importance. The method is to use a TV camera and monitor, with an endless tape loop so that there is a time-delay between the recording from the camera and the playback to the monitor. The subject thus sees his hands (or any other object) in the past; the delay being set by the gap between the Record and Play-back heads.

This situation is not only of theoretical interest, but is also of practical importance because controls used in flying aircraft, and operating many kinds of machine, have a delay in their action: if such delay upsets the skill, this could be a serious matter. It was found that a short delay (about 0-5 seconds) made movements jerky and ill co-ordinated, so that drawing became almost impossible, and writing quite difficult. Practice gives little or no improvement.

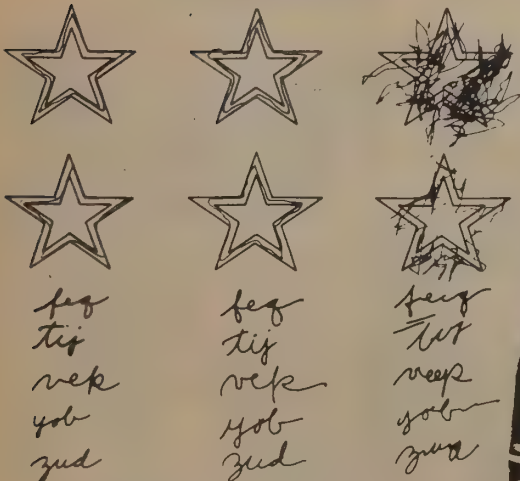

*Eye and Brain — The Psychology of Seeing*  
R.L. Gregory  
1966; 254 pp.

**\$2.45** postpaid from:  
McGraw-Hill Book Company  
Princeton Road  
Hightstown, N.J. 08520  
Manchester Road  
Manchester, Missouri 63062  
8171 Redwood Highway  
Novato, California 94947  
or  
WHOLE EARTH CATALOG

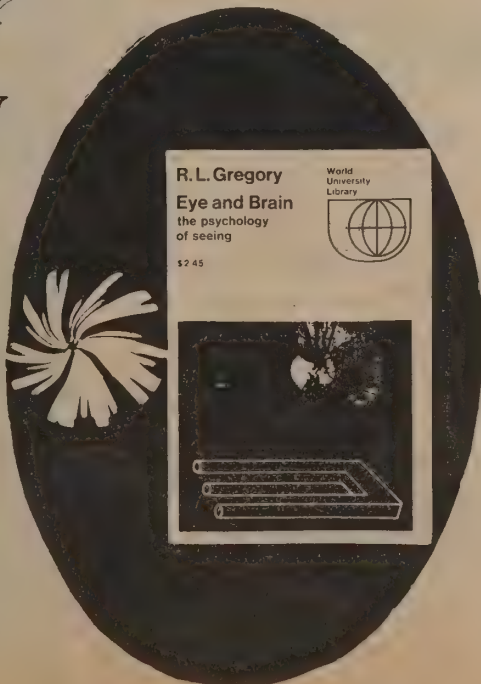

**Design for a Brain**

This is a reputation review. Ashby's book is found prominent in the bibliography and footnotes of every text we've seen on computers and the mind. It's technical going to read but worth it for the insights of prime work.

Finding an optimum is a much more complex operation than finding a value that is acceptable (according to a given criterion). Thus, suppose a man comes to a foreign market containing a hundred kinds of fruit that are quite new to him. To find the optimum for his palate he must (1) taste all the hundred, (2) make at least ninety-nine comparisons, and (3) remember the results so that he can finally go back to the optimal form. On the other hand, to find a fruit that is acceptable he need merely try them in succession or at random (taking no trouble to remember the past), stopping only at the first that passes the test. To demand the optimum, then, may be excessive; all that is required in biological systems is that the organism finds a state or a value between given limits.

The development of life on earth must thus not be seen as something remarkable. On the contrary, it was inevitable. It was inevitable in the sense that if a system as large as the surface of the earth, basically polystable, is kept gently simmering dynamically for five thousand million years, then nothing short of a miracle could keep the system away from those states in which the variables are aggregated into intensely self-preserving forms.

This is the learning mechanism. Its peculiarity is that the gene-pattern delegates part of its control over the organism to the environment. Thus, it does not specify in detail how a kitten shall catch a mouse, but provides a learning mechanism and a tendency to play, so that it is the mouse which teaches the kitten the finer points of how to catch mice.

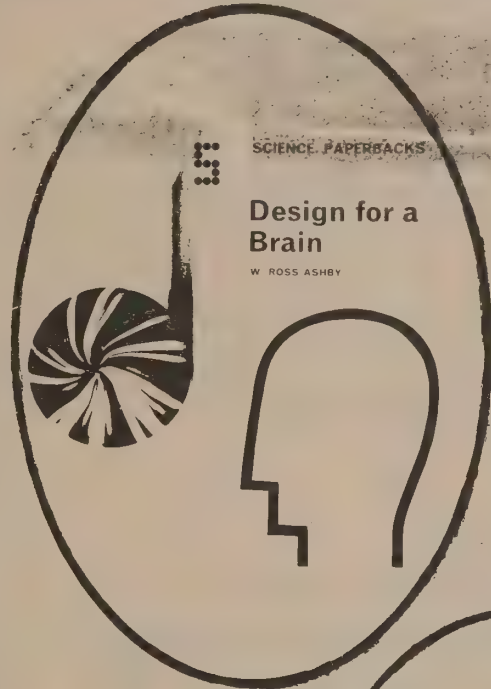

*Design for a Brain*  
W. Ross Ashby  
1952, 1960; 286 pp.

**\$2.85** postpaid  
from:  
Barnes & Noble, Inc.  
105 Fifth Avenue  
New York, N.Y. 10003  
Economy Bookstore  
171 W. Madison  
Chicago, Illinois 60602  
or  
WHOLE EARTH CATALOG

Communication 35

**Education Automation**

*Education Automation*  
R. Buckminster Fuller  
1962; 88 pp.

**\$1.95** postpaid

from:  
Southern Illinois University Press  
600 West Grand  
Carbondale, Illinois 62903  
or  
WHOLE EARTH CATALOG

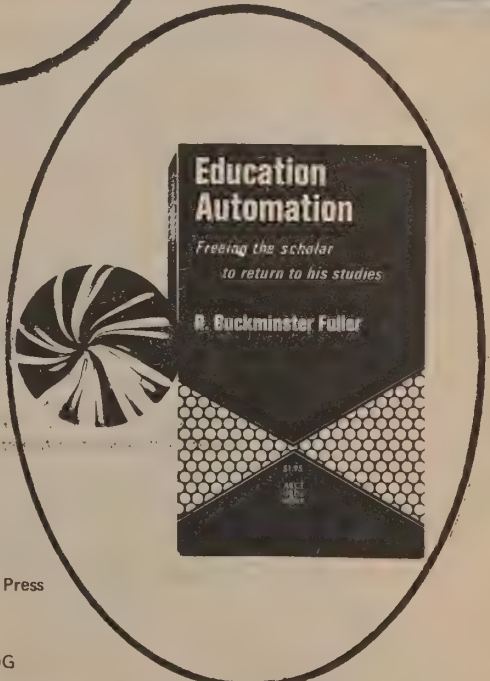

This book is listed under "Communication" rather than "Learning" because Fuller is mainly concerned with access in this book: designing ready access to comprehensive and replicable information and designing mobility as the basis of education.

I would say, then, that you are faced with a future in which education is going to be number one amongst the great world industries, within which will flourish an educational machine technology that will provide tools such as the individually selected and articulated two-way TV and an intercontinentally net-worked, documentaries call-up system, operative over any home two-way TV set.

We also find that generally speaking The geographically larger the physical task to be done, the duller the conceptual brain that is brought to bear upon the integration of the scientific discoveries and their technically realized applications. Finally, we get to international affairs, and you know what is happening today.

I would counsel you in your deliberation regarding getting campuses ready now to get general comprehensive environmental controls that are suitable to all-purposes like a circus. A circus is a transformable environment.

## Intelligent Life in the Universe

*Methodically blow your mind. The information in this book, mutually massaged by the American and Soviet co-authors, proceeds from superb introductions to evolutionary astronomy and biology, through a complete presentation of recent discoveries of astronomy and space science, to brilliant speculation on the parameters of inter-civilization communication. It's the best general astronomy book of recent years but that's nothing next to its impact on all the biggest questions we know.*

The existence of more than one universe is impossible, by definition.

In our discussion up to this point, we have considered only interstellar radio contact among civilizations at or just slightly beyond our present state of technical advance. Yet the bulk of technical civilizations in the universe may be immensely more advanced than ours—perhaps even billions of years beyond. The Soviet astrophysicist N.S. Kardashev, an associate of I.S. Shklovskii at the Sternberg Astronomical Institute, has considered the possibility of the detection of signals from such greatly advanced civilizations. He classifies possible technologically advanced civilizations in three categories: (I) A level of technological advance close to that of the contemporary terrestrial civilization. The rate of energy consumption is about  $4 \times 10^{19}$  ergs  $\text{sec}^{-1}$ . (II) A civilization capable of utilizing and channeling the entire radiation output of its star. The energy utilization would then be comparable to the luminosity of our Sun, about  $4 \times 10^{33}$  ergs per second. In Chapter 34, we will consider a specific proposal for the harnessing of such power. (III) A civilization with access to the power comparable to the luminosity of an entire galaxy, some  $4 \times 10^{44}$  ergs per second.

Taken at face value, the legend suggests that contact occurred between human beings and a non-human civilization of immense powers on the shores of the Persian Gulf, perhaps near the site of the ancient Sumerian city of Eridu, and in the fourth millennium B.C. or earlier. There are three different but cross-referenced accounts of the *Apkallu* dating from classical times.

Almost any other of the many accounts of alleged contacts of human beings with the crews of flying saucers—accounts which regale the flying saucer societies—follow the same pattern and stress the same points. The extraterrestrials are human, with few even minor physical differences from local cosmetic standards. (I know of no case of Negro saucerians, or Oriental saucerians, reported in the United States; but there are very few flying saucer reports made in this country by Negroes or by Orientals.)



Hardcover edition

*Intelligent Life in the Universe*  
I.S. Shklovskii and Carl Sagan  
1966; 509 pp.

\$9.95 postpaid

from:  
Holden-Day, Inc.  
500 Sansome Street  
San Francisco, California 94111

or \$2.95 postpaid

from:  
Delta Books  
c/o Montville Warehousing Co., Inc.  
Changebridge Rd.  
Pine Brook, N.J. 07058  
900 Pratt Blvd.  
Elk Grove Village, Illinois 60007  
1104 S. Lawrence Street  
Los Angeles, Calif. 90021  
or  
WHOLE EARTH CATALOG

But how can a natural satellite have such a low density? The material of which it is made must have a certain amount of rigidity, so that cohesive forces will be stronger than the gravitational tidal forces of Mars, which will tend to disrupt the satellite. Such rigidity would ordinarily exclude densities below about  $0.1 \text{ gm cm}^{-3}$ . Thus, only one possibility remains. Could Phobos be indeed rigid, on the outside—but hollow in the inside? A natural satellite cannot be a hollow object. Therefore, we are led to the possibility that Phobos—and possibly Deimos as well—may be artificial satellites of Mars.

"Well, ladies and gentlemen," Struve concluded, "it was pretty dull on Epsilon Eridani and Tau Ceti eleven years ago."

With  $10^{11}$  stars in our Galaxy and  $10^9$  other galaxies, there are at least  $10^{20}$  stars in the universe. Most of them, as we shall see in subsequent chapters, may be accompanied by solar systems. If there are  $10^{20}$  solar systems in the universe, and the universe is  $10^{10}$  years old—and if, further, solar systems have formed roughly uniformly in time—then one solar system is formed every  $10^{-10} \text{ yr} = 3 \times 10^{-3}$  seconds. On the average, a million solar systems are formed in the universe each hour.

### The McGraw-Hill Encyclopedia of Space

*Merry Christmas? A big candy-colored multi-national compendium of Earth's effort to get its rocks off. If the cost gets you, wait eight months until it's remaindered.*

*The McGraw-Hill Encyclopedia of Space*  
1968; 831 pp.

\$27.50 postpaid

\$23.95 postpaid before January 1, 1969

from:  
McGraw-Hill Book Company  
Princeton Road  
Hightstown, N.J. 08520  
Manchester Road  
Manchester, Missouri 63062  
8171 Redwood Highway  
Novato, California 94947

The information contained in a single human sperm cell is equivalent to that of 133 volumes, each of the size and fineness of print of *Webster's Unabridged Dictionary*.

So, by an interesting coincidence, the distances between the stars in interstellar space, relative to their diameters, are just about the same as the distances between the atoms and molecules in interstellar space, relative to their diameters. Interstellar space is as empty as a cubical building, 60 miles long, 60 miles wide, and 60 miles high, containing a single grain of sand.

Radio astronomers may be interested to know that the so-called "brightness temperature" of the Earth at television wavelengths is some hundreds of millions of degrees. This is 100 times greater than the radio brightness of the sun at comparable wavelengths, during a period of low sunspot activity.

▽ An advanced technical civilization is trying to communicate with us. But how can we possibly understand what they are saying? They are not likely to speak English or Russian. They have had a different evolutionary history. They are on a planet with perhaps an entirely different physical environment. Their thought

Decode this:

```
11110000101001000011001000000010000010100
10000011001011001111000001100001101000000
00100000100001000010001010100001000000000
00000000001000100000000000101100000000000
00000001000111011010101010000000000000000
0000100100001110101010101000000000101010101
000000000011101010101110101100000001000000
000000000001000000000000001000100111111000
00111010000010110000011100000001000000000
10000000010000000111110000001011000101110
1000000011001011111010111100010011111001
0000000000011111000000101100011111100000
1000011000001100001000011000000011000101
001000111100101111
```

FIGURE 30-1. A hypothetical interstellar message due to Frank Drake. The 551 zeros and ones are representations of the two varieties of signals contained in the message. The problem is to convert this sequence of 551 symbols into an intelligible message, knowing that there has been no previous communication between the transmitting and receiving civilizations.

into this:

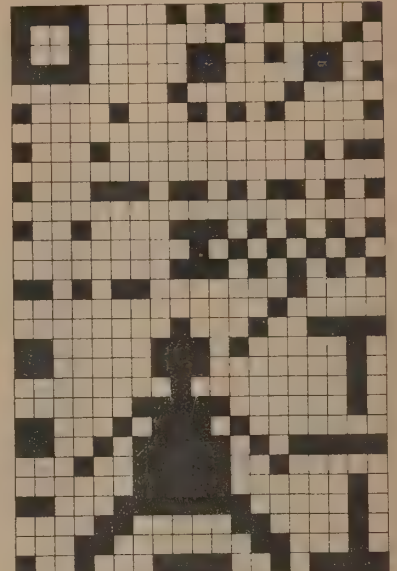

Now decode this for physiological, astronomical, chemical, mathematical, social, historical, and linguistic information.

36 COMMUNICATIONS



Lafayette and Allied Catalogs

Quantities of gear, Plug in, link up, incorporate.



VECTOR ETCHED CIRCUIT KIT

Designed for making low cost etched circuits with the least amount of bother. Circuit can be sketched on grid layout paper provided. Once best circuit is found, Vectoresist can be used to transfer circuit to copper-clad board. Board is then put in bag containing chemical solution and agitated. Circuit takes less than 10 min. to etch. Kit includes two 4 1/2 x 6 1/2" phenolic boards; one sheet Vectoresist with assorted pad layouts, lines, circles, and connector patterns; etching chemical; grid layout paper; "practice" copper-clad pieces. 19 T 8356 Shpg. wt., 1 1/2 lbs. Net 6.50

2 CHANNEL Lafayette

7-TRANSISTOR SUPERHET CB WALKIE TALKIE HA-73A

- Built-in Call Alert
- Powerful Push-Pull Audio
- Battery Eliminator Jack

New power boost reflex circuit utilizes 7 transistors to achieve higher sensitivity for extended range. 2-channel operation permits greater flexibility. Call alert system sends or receives a pleasant alerting tone for convenient calling. Also features Battery Eliminator Jack for 117 Volts AC operation with optional battery eliminator. Case features beautiful die-cast chrome high-lighted front panel. Supplied with carrying strap, telescoping antenna, battery, and plug-in crystals for channel 9. Size: 5 7/8" x 1 1/4" x 2 3/4". Imported. Shpg. wt., 3 lbs. Net ea. 15.95

2 CHANNEL 7-TRANSISTOR SUPERHET WITH CALL ALERT

15.95 Each

No License Required  
FCC Regulation Part 15  
496 Lafayette Cat. No. 690

Heathkit

Between readymade and do-it-yourself is do-it-yourself: Heathkit. It's good electronic equipment of a wide variety. (Current catalog lists Servo Chart Recorders, Analog Computers, Combo Organs.) Assembling yourself saves 25-40%, plus education, minus time.

Heathkit Catalog Free  
1969; 115 pp.

from:  
Schlumberger Products Corporation  
P.O. Box 167  
St. Joseph, Michigan 49085

[Suggested by Arthur Brand]



Practice your guitar playing in private... only you can hear when you use this handy little unit. Or use two pairs of headphones so just you and your teacher can hear your playing. The all-transistor circuit is powered by a miniature 9 v. battery (not included) which will last up to 60 hours. This compact amplifier plugs directly into your guitar and will drive one or two pairs of stereo or monophonic headphones. Tone and volume may be varied by your guitar controls. The amplifier automatically turns on as you plug it into your guitar. Build it in one evening.

Kit TA-58, 2 lbs. \$11.95

Heathkit Visual-Aural Signal Tracer . . . Speeds Trouble-shooting

- Ideal for trouble-shooting transistor & tube-type AM receivers & audio equipment
- Traces RF, IF, and audio signals
- Locates troublesome noisy or intermittent components
- Convenient audio/ RF probe with switch
- Doubles as a test amplifier or speaker

A QUICK, SAFE WAY TO TROUBLE-SHOOT TRANSISTORIZED CIRCUITRY . . . applies no voltage to circuit under test. Safe for delicate transistor circuits easily damaged through ordinary vacuum tube testing procedures. And even the minute signals of phono pickups, etc., can be checked out, since the IT-12 features a high-gain amplifier with adjustable level control. A worthwhile investment for time-saving test facilities.

Kit IT-12, 6 lbs. \$26.95  
Export model available for 115/230 VAC, 50-60 Hz; write for prices.

IT-12 SPECIFICATIONS—Power supply: Transformer operated. Power requirements: 117 volts 50/60 Hz AC, 25 watts. Tube complement: 12AX7, 12CA5, 1629. Speaker: 3 1/2" PM. Probe and test leads: 4' input lead for RF and audio with switch on probe body, 2-3' panel test leads with alligator clips. Dimensions: 4 1/2" W x 7 1/2" H x 4" D.



GW-22A  
\$56.50

Kit TA-58  
\$11.95

New Heathkit Guitar Headphone Amplifier For Private Practice and Instruction

Modern Business Forms

This item is listed in response to queries from friends and correspondents who like the WHOLE EARTH CATALOG stationary and want some. Drawing Board has a good range of inexpensive and untroublesome business forms, personalized, but not pretentious.

[Suggested by Richard Raymond]

Modern Business Forms Catalog  
47 pp.

Free

from:  
The Drawing Board, Inc.  
9030 Viscount Row  
Dallas, Texas 75221

WINDOW ENVELOPES (ITEM EV3-G)  
Especially designed for use with Note-O-Gram III and Memo-letter III on the next page. This envelope matches your letter forms in color, layout and type style giving your correspondence a distinctive look that gets attention and quick results.

ITEM	500	1000	2000	3000	4000	5000
N3-R73 Note-O-Gram III	\$14.95	26.75	47.60	65.85	82.00	97.50
EV3-G Note-O-Gram III Envelope	\$ 8.85	13.85	23.10	34.50	45.30	55.75

A distinctive new design:  
NOTE-O-GRAM III

Get out twice as much correspondence with this modern, efficient 3-part letter form that eliminates addressing envelopes and gives both the sender and recipient copies of every message and reply.

Proven in thousands of offices across the country, Note-O-Grams are perfect for all routine correspondence. They always get attention and bring fast replies.

Easy as A-B-C to use  
A: Write or type your message on the white part and snap out the yellow copy for later follow-up. B: Fold the completed message just once and slip into a standard #10 window envelope. There's no addressing of envelopes needed, a real time saver. C: The recipient replies on the white part and keeps the pink copy. This gives both parties the completed message on one sheet of paper.

Eico 70-Watt Stereo Phono System

Separately, \$318.80. Delivers first-rate performance at a low price. Factory-assembled, ready to plug-in-and-play Eico "Cortina" 3070 70-Watt Solid-State Stereo Amplifier boasts silicon transistors. Includes smart walnut finish metal case. Garrard Synchro-Lab SL55 4-Speed Automatic Turntable has oversize platter, cueing feature. With base. Shure M32E Stereo Cartridge with elliptical diamond stylus. Two Allied 3005A 3-Way Walnut Speaker Systems with 10" woofer, 6" midrange, 3 1/2" tweeter. With cables, hi-fi booklet. Shpg. wt., 65 lbs. 13 C 0349 D4U. \$13 Monthly. 249.25

Save \$64.55  
\$249.25  
With Case \$13 monthly



Lafayette Catalog  
1969; 511 pp.

Free from:  
Lafayette Radio Electronics  
111 Jericho Turnpike  
Syosset, L.I., N.Y. 11791

LAFAYETTE VARIABLE TUNING CONDENSER FOR CB & 10 METER RIGS

- Used in Famous Lafayette HE-20A and HE-15A Transceiver

A single ganged, variable tuning condenser offering unlimited possibilities to the experimenter, ham, and hobbyist in building Citizen Band Transceivers and 10 Meter rigs. This condenser is used by Lafayette engineers in their famous HE-20A and HE-15A Transceivers. The unusually fine vernier action of the tuning shaft allows for the very precise adjustment needed to select the closely spaced channels of the 27 MHz Citizen's Band frequencies. Rotates thru a full 180°. Single ganged, having a shaft with an overall length of 1 1/4 inches. Can be top or front panel mounted. Well constructed with a minimum capacity of 6.5 mmf., and a maximum capacity of 13 mmf. Dimensions 1 3/4 x 1 3/4 x 1 3/4 inches excluding shaft. Shpg. wt., 3 oz. 32 T 0917

Net 1.95



Allied Catalog  
1969; 535 pp.

Free

from:  
Allied Radio  
100 N. Western Avenue  
Chicago, Illinois 60680

"SKIPPER" TIME SWITCHES

Handle up to 12 on off operations. Can be set to skip one or more days.



Permit "skipping" control cycle. Have two dials: a time dial and a day dial. Days are skipped by inserting small skipper screws into day dial. "On" and "off" trippers are set in time dial. Special "cutout" taper rollers the day dial every 24 hours. 1 p to 12 operations per day can be obtained by adding trippers. Range: minimum "on" or "off," 1 hour; maximum 23 hours. Silver contacts rated 10 amps (4875 volts, tungsten) at 125 V, 75 A, 55.3° V L L, and 1 or 110 120 V, 60 Hz AC. Shpg. wt., 8 lb.

Stock No.	Type	Action	Each
58 C 8315	T171	SPST	12.22
58 C 8316	T173	DPST	13.62
58 C 8317	T175	SPDT	12.62

Use Heath's Free Technical Consultant Service—Write Them On Any Kit Subject

5-Channel, 5-Watt CB Transceiver . . . Choice Of Fixed Or Mobile

- 5-crystal-controlled transmit & receive channels
  - Superhet receiver with RF stage
  - Built-in squelch & automatic noise limiter
  - Push-to-talk microphone
  - Easy to build
- A HOST OF OPERATING CONVENIENCES like 5 crystal-controlled transmit and receive channels . . . sensitive superhet receiver with RF stage . . . built-in squelch and automatic noise limiter . . . built-in speaker plus external connectors for adding an extra speaker if desired . . . relayless push-to-talk circuitry and rugged two-tone brown metal cabinet. Includes PTT microphone, power cable and crystals for one channel (specify frequency). Choose the AC model for "fixed," and the DC version for "mobile" operation. Choose them both and save an extra 5%. Use must comply with FCC regulations.

Kit GW-22A (117 v. AC), 13 lbs. \$56.50  
Kit GW-22D (6 or 12 v. DC), 13 lbs. \$58.50

GENERAL DESCRIPTION—Receiver: 5-tube superheterodyne with RF stage, crystal-controlled, on up to 5 of the 23 channels as determined by the particular crystal(s) installed. Sensitivity: 1/2 microvolt for a 10 dB signal-to-noise ratio. Transmitter: Power input to final RF amplifier, nominal 5 watts. Nominal power requirements: GW-22A—117 volts, 50/60 Hz AC, 50 watts. GW-22D—6 volts DC, 8.0 amperes; 12 volts DC, 4.5 amps. Dimensions: 9 1/2" D x 6 1/2" H x 9 1/2" W.

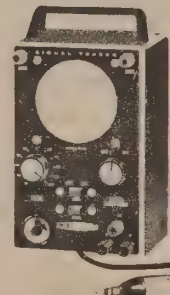

Kit IT-12  
\$26.95

Communications 37

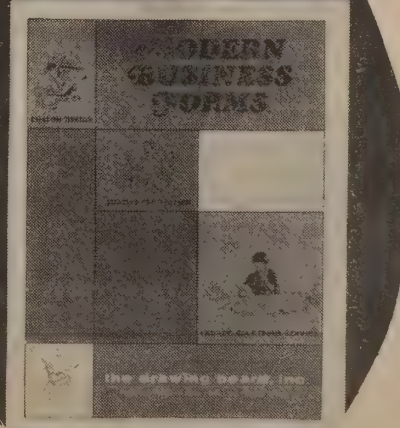

Accurate, specific information on what's new in equipment, techniques, standards, and the attitudes of technicians using them. Also gossip and news about who's doing what where. Covers all aspects of professional filmmaking from Hollywood Super Panavision 70mm to 8mm educational loops.

The ads, fully as important as the text, are mouthwatering for those with an appetite for Eclairs and such.

If you read it regularly you'll never need Baddeley—you'll know how it's really done. Often the information is directly and simply usable; sometimes it stimulates visions of the super-cinema of the future. When in school I consulted back issues for a psychology paper on perception. The articles are really interesting and, best of all, there is no film criticism, so you avoid all those negative emotions.



[Suggested by Gordon Ashby  
Reviewed by Sandra Tcherepnin]

\$6.00 for one year (monthly)

from:  
American Cinematographer  
1782 North Orange Drive  
Hollywood, California  
90028



For the 16mm film-maker who can't afford the real thing—a creditable substitute set-up to aid in cutting sync-sound film

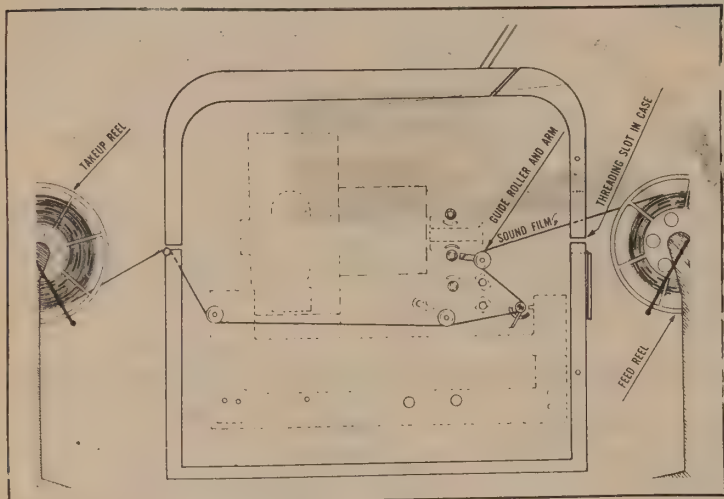

Diagram indicating the threading pattern necessary in order to use the Bell & Howell Model 702 as a sound reader. Sprocketed rollers are bypassed to permit free flow of the film. The auxiliary guide roller, mounted on a metal arm, is attached to the chassis of the projector using the front set screw which holds the middle sprocket roller into the machine. The track is mounted on a geared rewind capable of holding a 2,000-foot reel in

QUESTION: In what unusual ways did you utilize the telephoto lenses you mentioned earlier?

WEXLER: The 400mm lens was especially useful in the polo sequence because it focuses down to 15 feet. We were able to focus on something very sharply at 15 feet and then, by throwing the focus back to something at infinity, make the foreground object literally disappear. We used that effect, forward and in reverse, several times. For example, the opening scene of the polo sequence is a shot of thundering horses' hooves, over-cranked for slow motion, with heat waves shimmering through the frame. Then, as they come toward you, the focus goes to a polo ball which literally fills the frame, and there's a sharp "whack" as the mallet drives it out of frame. It makes a pretty good beginning for the sequence.

On the streets and in the buildings of Boston, a Hollywood motion picture crew films sequences for a high-style tale of bank robbery for kicks

Try not to be put off by the word "documentary."

This is a book for times when you are starved for some lea... and specific information. It covers all conventional aspects of filmmaking: subtle items, which can really best be learned by the experience of seeing and working on films (use of dissolves, effect of different lens lengths, etc.); necessary conventions, like systems of marking workprints, and technical facts about equipment; and the hundreds of little hints and tricks, some whimsical some incredibly mundane, which technicians have hit upon by trial, error and inspiration over the years. All of these are discussed in the same thorough, detached, insensitive way. But at least the basic information is there so you can get it if you need it. This book will not help you to learn filmmaking—you'll have to bring along the enthusiasm and involvement—so start filming and then use it when you have to.

[Reviewed by Sandra Tcherepnin]

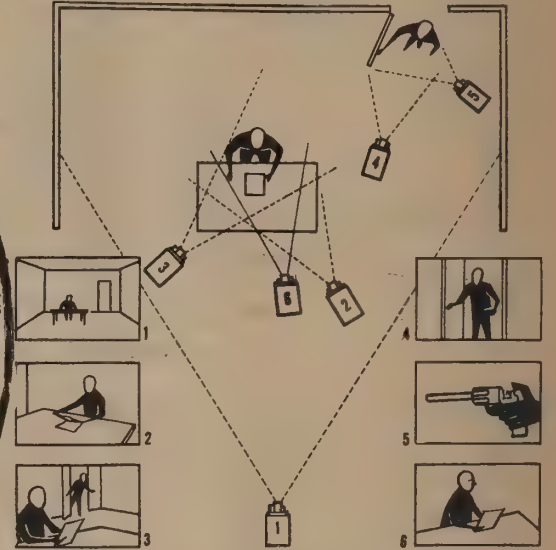

CONVENTIONAL CUTTING ROOM SIGNS. 1. Unintentional join. 2. Unintentional joins made to insert a patch replacing a damaged portion of work-print. Ignore when matching master. 3. Extended scene. 4. Fade out and fade in. 5. Dissolve. These signs are drawn on the work-print by the editor, usually with a Chinagraph pencil, to guide the person matching the master.

38 Communications "THE NEW DIMENSION"

Several classic methods for creating Special Effects—with and without an Optical Printer

8mm is on the verge, and by verge, I mean it is about 8 1/2 months pregnant, of delivering to us a great big, brand new opportunity to mold and shape something entirely new.

16mm FILM DIMENSIONS

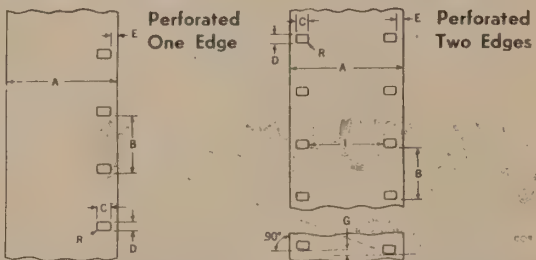

FILM	ASA STAND.	FILM DIMENSIONS (Inches)								
		A	B	C	D	E	G	I	L*	R
16mm, 2R-3000	PH22.5	0.629	0.3000	0.0720	0.0500	0.036	0.001	0.413	30.00	0.010
16mm, 1R-3000	PH22.12	0.629	0.3000	0.0720	0.0500	0.036			30.00	0.010
16mm, 1R-2994	PH22.109	0.628	0.2994	0.0720	0.0500	0.0355			29.94	0.010
16mm, 2R-2994	PH22.110	0.628	0.2994	0.0720	0.0500	0.0355	0.001	0.413	29.94	0.010

\*This dimension represents the length of any 100 consecutive perforation intervals.

"The Film Works" in San Francisco

Groot Productions and Patterson & Hall have formed "The Film Works," San Francisco's newest and possibly most complete establishment for "source-in-depth" creative film production for television, business and education. Offices are at 425 Bush Street, San Francisco, Calif. 94108, telephone 362-5230.

For the film-maker on a budget—a way to make equipment serve a double-duty purpose

Anyone who edits film may be interested in the mechanical 16mm system I use. It is simple and economical.

American Cinematographer Manual

Indispensable data book, used by american cinematographers. Expensive, because it is absolutely comprehensive, up to date, from Hollywood, and has no competitors.

American Cinematographer Manual  
Joseph V. Mascelli, A.S.C., ed.  
500 pp.

\$12.50 postpaid

from:  
The American Cinematographer Manual  
P.O. Box 2230  
Hollywood, California 90028  
or  
WHOLE EARTH CATALOG

eclair

More than 600 pocket-size pages of concise, practical, informative text, tables, charts, diagrams, drawings and listings of all the latest production equipment and filming techniques in use today!  
Key word printed on the edge of every right-handed page provides INSTANT INDEX for quickly locating desired data!

The Technique of Documentary Film Production  
1963; 268 pp.

\$10.00 postpaid

from:  
Communications Arts Books  
Hastings House, Publishers, Inc.  
151 East 50th Street  
New York, N.Y. 10022

If we see a man in medium shot and then take a closer look at him in close-up, he must be in the same position in both shots—or, to be more precise, he must be in the same position at the end of the medium shot as when we cut to him at the beginning of the close up. In real life this would automatically be so; when we film him we must somehow ensure that it is so despite the fact that, in changing our lens or camera position, there has been a lapse of time. On the face of it, this point appears obvious. It is all the more surprising, therefore, that many beginners fail to appreciate it and assemble their shots with serious continuity errors between them, thinking that the audience will not be bothered by them.

Avoiding Paper Rustle

There is, for instance, that very basic requirement of ensuring that the turning of pages or the rustling of the script is not picked up by the microphone. This is usually got around by mounting the pages of the script separately on cardboard. There is still the problem of how to attach the sheets to the boards. Rubber bands are commonly used, but they can become caught in the adjacent board and emit a loud "twang"! Paper clips are an alternative, but there is a great tendency for one board to become attached beneath the clip on the next just at the moment when it is necessary to move quickly to a fresh page. A possibility is to use an adhesive such as Cow gum, but this may take longer. An ingenious alternative is to type the script on blotting paper which will not, of course, rustle. The drawback here is that it is not easy to take a carbon copy when typing on blotting paper—unless the blotting paper is the carbon copy, in which event the commentator may not find it clear enough to read.



# The Techniques of Television Production

I'm coming to believe that good how-to writing mostly depends on good diagramming. Millerson has mastered that, so you're inclined to believe that he knows his television. Certainly he covers the ground in a thorough fashion: studio layout, TV picture and camera, TV lighting, sound, film reproduction, sets, make-up, organization, imagery, camera control, editing, sound composition, production method, titling, effects, and color. The book can make a more critical viewer of you. Or it can give you some skill to go with the power when you demand and get some control of the half-hour educational program about your scene.

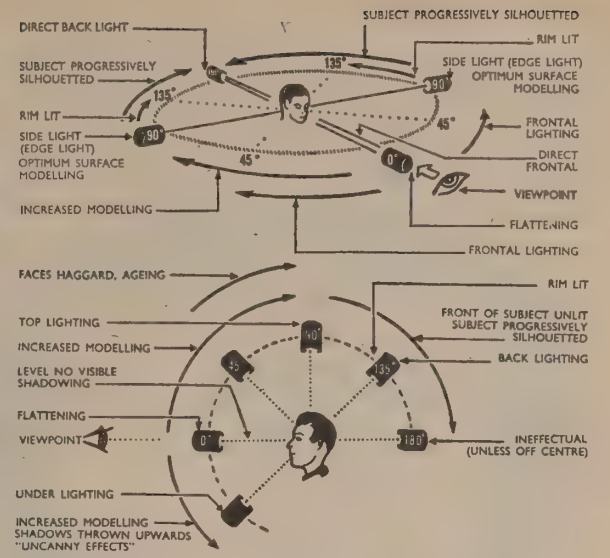
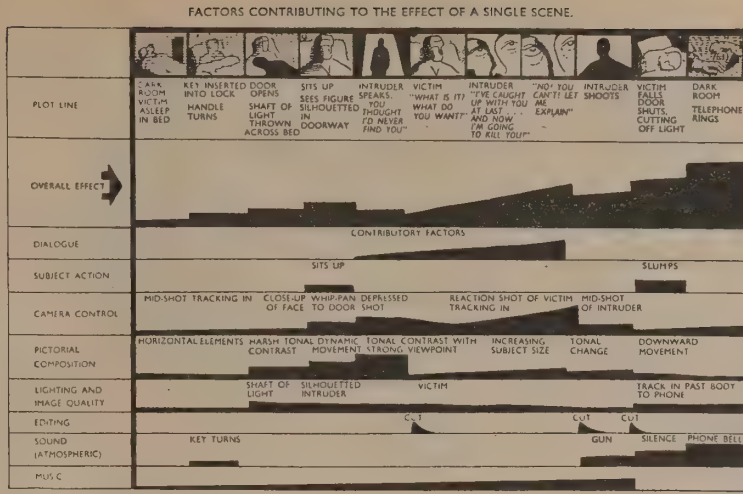

## INSTRUCTIONS TO SWITCHER (vision mixer)

Instructions	Meaning
Take one: Cut to One	Switch to Camera 1's picture.
Stand by to fade Two	Prepare to fade Camera 2's picture out.
Ready to fade Two	
Fade: fade out: fade to black	
Stand by to mix: dissolve Two	Turn transmitted camera's video-fader down from full, to zero.
Mix to Two: dissolve to Two	Warning before mixing-cue. Mix from present camera being transmitted, to Camera 2's picture.
Superimposing Three: ready to super Three	Warning before superimposition-cue.
Superimpose: add Three	Fade Camera 3's picture up, adding it to existing sources.
Take Two out: lose Two	Remove (usually fade) Camera 2's picture from transmission; leaving the rest.

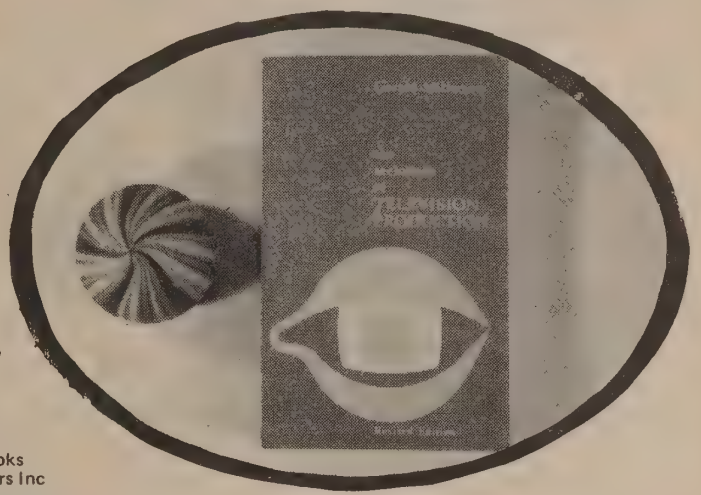
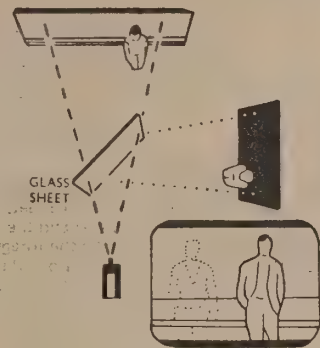

LIGHTING ANGLE. The lighting angle we choose depends on which particular features we want to display, e.g. roundness, surface-texture, relief.



CROWDS can be simulated by using selective viewpoints (left) and carefully positioned subjects crowded together along the lens axis (centre). Also by augmenting subjects with a background of a crowd scene (moving back-projection, photo-mural, painted cloth) or using dummy or cut-out foreground figures (right).

**The Technique of Television Production**  
 Gerald Millerson  
 1961; 1968; 440 pp.  
 \$7.20 postpaid from:  
 Communication Arts Books  
 Hastings House, Publishers Inc  
 10 East 40th St.  
 New York, N.Y. 10016

## Auto Repair Manual

Said to be the standard of the business, Chilton's Auto Repair Manual comes out yearly in the Fall (1969 is just out), but it covers American cars since 1960 (including Volkswagen). Covers indeed: in addition to sections on trouble shooting and repair of various units (alignment, brakes, carburetor, clutch, starter, steering, suspension, etc.), there is about 30 pages on each make of car (37 in all). If you're not interested in Detroit, Chilton publishes individual manuals authored by Harold T. Glenn on foreign cars, VW (\$3.95), trouble shooting (\$1.95), as well as a non-Glenn "Motorcycle Repair and Tune-up Guide" (\$3.95). [Hey, would somebody out there mind telling us the difference between Glenn's Auto Repair Manual (\$9.95) published by Chilton, and Chilton's Auto Repair Manual (\$11.00)?]



from:  
 Chilton Book Company  
 Attn. Customer Service Dept.  
 401 Walnut Street  
 Philadelphia, Pa 19106

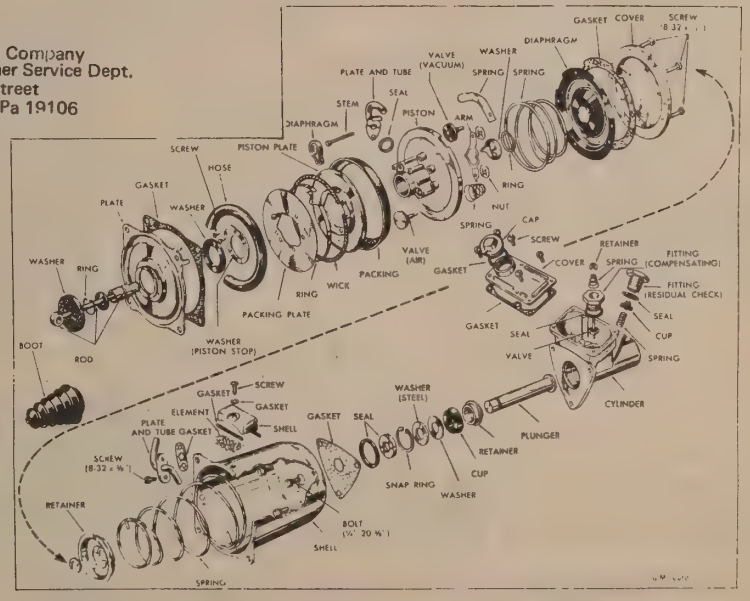

[Suggested by Jay Baldwin.  
 Reviewed by Know Nothing]

### JUMPING OUT OF HIGH GEAR

- Misalignment of transmission case or clutch housing.
- Worn pilot bearing in crankshaft.
- Bent transmission shaft.
- Worn high speed sliding gear.
- Worn teeth in clutch shaft.
- Insufficient spring tension on shifter rail plunger.
- Bent or loose shifter fork.
- End play in clutch shaft.
- Gears not engaging completely.
- Loose or worn bearings on clutch shaft or main shaft.

### STICKING IN HIGH GEAR

- Clutch not releasing fully.
- Burred or battered teeth on clutch shaft.
- Burred or battered transmission main shaft.
- Frozen synchronizing clutch.
- Stuck shifter rail plunger.
- Gear shift lever twisting and binding shifter rail.
- Battered teeth on high speed sliding gear or on sleeve.
- Lack of lubrication.
- Improper lubrication.
- Corroded transmission parts.
- Defective main shaft pilot bearing.

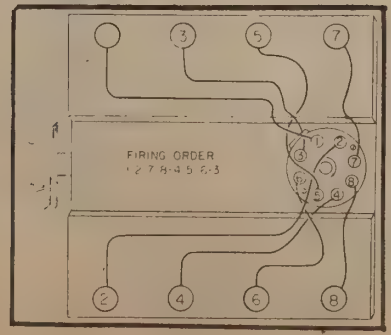

Firing Order



Books

What we have here is the first hip trade journal. "Books" is a scruffy newspaper made from somewhere inside the world of publishing. It pirates good stuff from new and interesting books almost as baldly as the CATALOG, and it revels in downtown gossip of who's happening. Good source of news about the intellectual wing of the current political-theatrical upwelling.

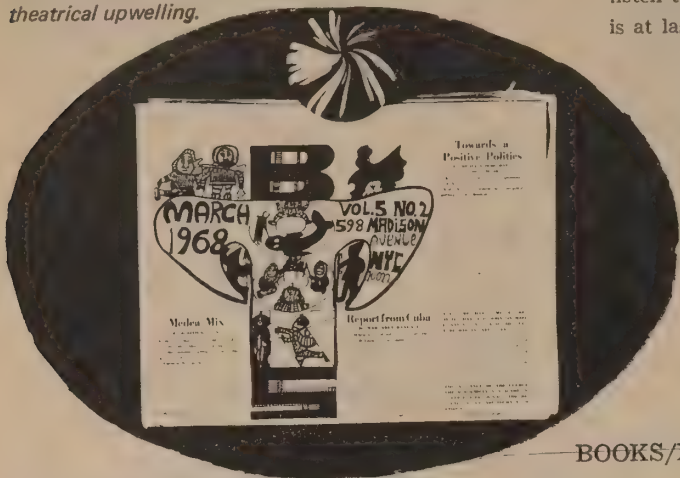

"Ho Chi Minh's Daughter"

"I have learned my English in bed. I mean it. Because I use to read many books, in bed. Because I use to listen to what my clients say, in bed."— is at last being published.

VIA I, Ecology In Design: The Student Publication. Selection of photographs prepared by graduate school of Fine Arts of the U. of Pennsylvania. Grossman \$5.00.

Birth of a Notion

Books  
Jerome Agel, ed.

\$3.00 for one year (monthly).

from:  
Books  
598 Madison Avenue  
New York, N.Y. 10022

The seminal book of 1969 will be Alvin Toffler's "Future Shock," published by Random House. No firm publication date has been set.

Future shock is a time phenomenon, the dizzying psychological shock suffered by people when they are forced to adapt and re-adapt repeatedly to an accelerating pace of changes in society. Hippies, Mr. Toffler writes, are already suffering from future shock.

Cass Elliot — I've never had my chemistry changed by a movie before as it was by "2001."

Vidal's "Myra Breckinridge," Bantam Books has purchased for \$1500 the 16-foot-high, 500-pound fiberglass statue in Hollywood that was photographed for the book cover and plans to tour it coast-to-coast, then offer it to a New York museum. The statue was used to advertise the Sahara Hotel of Las Vegas. Bantam considered a "Myra Breckinridge contest," with the winner getting a round-trip to Denmark, but decided...



The Blue Meenie

Arthur C. Clarke's "Childhood's End" and Robert Heinlein's "Stranger in a Strange Land" have been optioned for the movies . . .

BOOKS/March, 1968 5

—From "The Wind in the Willows"

"Now that I'm here, where am I?"

—Janis Joplin, West Coast blues-rock star after a stunning debut in New York, where it counts.

"The Poetry of Motion! The REAL way to travel! The ONLY way to travel! Here today — in next week tomorrow! Villages skipped, towns and cities jumped — always somebody else's horizon! O bliss! O poop-poop! O my!"

Subject Guide to Books in Print

Subject Guide to Books in Print  
Annually in the Fall; 2724 pp. (1967)  
\$18.25 postpaid

Subject Guide to Forthcoming Books  
\$7.50 for one year (bi-monthly)

from:  
R.R. Bowker  
1180 Avenue of the Americas  
New York, N.Y. 10036

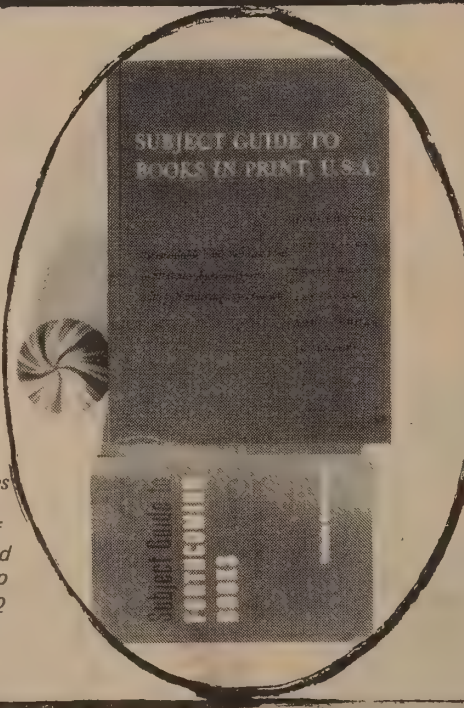

We use it; maybe you can. In one fat book are all the titles in print, along with cost and publisher, listed by subject category. Addresses or publishers are given in the front of the book. Outside of a library, there's no better way to find out what's available in a particular area. If you're trying to stay current in your field, the bi-monthly Subject Guide to Forthcoming Books may be preferable.

Electronics

Includes Radio & TV Technology

- A B C's of Electronic Test Equipment. Smith, D. A. rev. ed Aug. 1968 pap. 2.95 Sams
- Advanced Techniques for Troubleshooting with the Oscilloscope. Goodman, R. L. Nov 10, 1968. 7.95 pap. 4.95 GL. TAB Bks
- Advanced & Extra Class Amateur License Handbook. Pyte, H. S. 2nd ed. Aug. 1968. pap. 3.50 Sams
- Alain Resnais & the Theme of Time. Ward, J. Aug 9, 1968. 4.95 pap. 2.95 Doubleday
- Anglo-American Microelectronics Equipment Data. 1968-1969. 2 Vols. Ed. by Dummer, G. W. & Robertson, J. M. Aug. 1968. 46.00 ea; 90.00 set Pergamon.
- Antennas in Inhomogeneous Media. Galejs, J. Aug. 1968. 12.00 Pergamon.
- Art & Science of Photography. Newhall, B. et al date not set pap. 2.95 Century Hse
- Broadcast Station Operating Guide. Robinson, S. Sep 20, 1968. 9.95 pap. TAB Bks
- Choice of Weapons. Parks, G. (YA) Nov. 1968. pap. 0.75 Noble
- Classical Network Theory. Belevitch, V. Sep. 1968. 15.75 Holden-Day
- Closed-Circuit TV for Engineers & Technicians. Showalter, L. C. Oct. 1968. 8.50 Sams
- Color TV Servicing. Buchsbaum 2nd ed. Jul 10, 1968. 9.95 P-H
- Communications with Electricity-Electronics. Culpepper, M. A. (Eih) Nov 22, 1968. price not set. McKnight
- Computer Programming Principles, Vol. 2: Fortran. Wimmert, R. J. Sep 1, 1968. pap. 4.95x. HR&W
- Computer Programming Principles, Vol. 2: Machine-Assembly Language. Wimmert, R. J. Sep 1, 1968. pap. 4.95x. HR&W
- Data Acquisition & Processing in Biology & Medicine, Vol 5. Ed by Enlein, K. Aug. 1968. 16.00. Pergamon

- Electrical & Electronic Signs & Symbols. Middleton, R. G. Jul. 1968. pap. 4.50 Sams
- Electrical Installations Technology. Whiffield, J. F. Aug. 1968. 7.00 pap. 5.50 Pergamon
- Electronic Cable Handbook. Belden Manufacturing Company Engineering Staff 2nd ed. 1st ed. 1968. pap. 4.50 Sams
- Electronic Devices & Circuits, Vol. 1. Pridham, G. J. Aug. 1968. 7.00 pap. 5.00 Pergamon
- Electronics for the Beginner. Stanley, J. A. 2nd ed. Sep. 1968. pap. 3.95 Sams
- Electronics Handbook for the Electrician. Sands, L. G. Oct. 1968. 5.95 Chilton
- Equidensitometry. Lau, E. & Krug, W. Nov. 1968. 18.00 Focal
- Expansion Joints in Bridges & Roads. Koster, W. Nov. 1968. 29.50 Transatlantic
- Exposure Record. Adams, A. Jul 15, 1968. lea. spiral bdg. 4.95 Morgan
- Faces of Japan: A Photographic Study. Lensen, G. A. Nov. 1968. 30.00 Diplomatic
- Faces of Japan: A Photographic Study. Lensen, G. A. 1st ed. Nov. 1968. 27.50 Diplomatic
- Faults in Photography: Causes & Correctives. Fritsche, K. Sep. 1968. 12.50 Hastings
- Film Maker's Guide. Branston, B. Jul. 1968. 6.75. Hillary
- Five Girls. Haskins, S. Oct 1, 1968. pap. 1.45. Bantam
- From Electrons to Power. AC DC. Woolman, M. & Valentine, C. G. Jul. 1968. text ed. 9.20. Glencoe
- Fun with Tape. Staab, J. G. Aug. 1968. 5.95. A S Barnes
- Golden Web: A History of Broadcasting in the United States. Volume 2. 1933-1953. Barnouw, E. Oct 31, 1968. 9.00 Oxford U Pr.
- Gordon Parks: A Poet & His Camera. Parks, G. Intro by P. Kunhardt Jr. Pref by S. Spender. Nov 21, 1968. 8.95 Studio Viking Pr.
- Ham Radio Incentive Licensing Guide. Simon, B. Sep 30 1968. 6.95 pap. 3.95. TAB Bks
- Handbook of Modern Half-tone Photography. Noemer, E. F. rev ed. Aug. 1968. 11.80. Pagra Supply
- Handbook of Vacuum Physics. Pts. 4-6. Ed. by Beck, A. H. Aug. 1968. 6.00 Pergamon

Art Prints

Since 1949 UNESCO has been trying to update and internationalize the world of Art Prints. They have a central archives of prints, and a committee of experts who decide which prints to include in their catalogs. The criteria are: quality of print, significance of the painter, and importance of the painting.

There are two UNESCO print catalogs: Catalogue of Colour Reproductions of Paintings Prior to 1860 and the same of paintings 1860 to 1965. Both are understandably limited in scope by what quality prints are available. Paintings 1860 to 1965, the only one on hand to review, is further limited by the imbalanced outdated European standard used to select the 1590 prints presented. 225 painters are represented, allowing approximately 7 prints per painter. Yet there are 92 Picassos, 72 Renoirs, 61 Klees, 25 Manets, 50 Monets, 18 Kokoshkas(?) 18 Legers(?) and 36 Dufys(!) etc. Hence: 1 Dali, 1 Duchamp, 1 Ernst, 1 Wyeth, 0 De Chiricos. Further: questionable selection among 5 Magrittes and 6 Munchs. Not represented are contemporary Americans Albers through Zavorskas.



Out of place are three Australian aboriginal paintings.

Much is missing from this catalog yet it can still be useful. It lists only quality prints. Each entry includes the painter's name, place and dates of his birth and death, a black & white photo of the painting, its name, date, medium, size and the collection in which it rests. The printing process, printer (when possible) and publisher are given for each reproduction as well as the UNESCO archives number, dimensions and price (in currency of country where published when possible). Also there are lists of publishers and printers and information on purchasing prints.

Catalogs are trilingual in French/English/Spanish and all dimensions are given in both inches and centimeters.

If you want good prints for the classroom or other irritating empty space—try these catalogs. [Reviewed by Joe Bonner]

GAUGUIN

430 LA FEMME DU ROI (LA FEMME AUX MANGUES) / THE KING'S WIFE / LA ESPOSA DEL REY, 1896

Huile sur toile, 97x130 cm — Oil on canvas, 38 1/4 x 51 1/4 in.  
Gosudarstvennyj muzej izobrazitel'nyh iskusstv imeni A. S. Puškina, Moskva

Reproduction: Offset, 21,3x28 cm — Offset, 8 1/2 x 11 in.

Unesco Archives: G.268-69

Editions Est-Ouest

Editions Est-Ouest, Bruxelles, 50 FB

Catalogue of Color Reproductions of Paintings Prior to 1860

Catalogue of Color Reproductions of Paintings 1860-1965

1966; 561 pp.

\$7.00 each, postpaid

from:  
International Publications Service  
303 Park Avenue South  
New York, N.Y. 10010

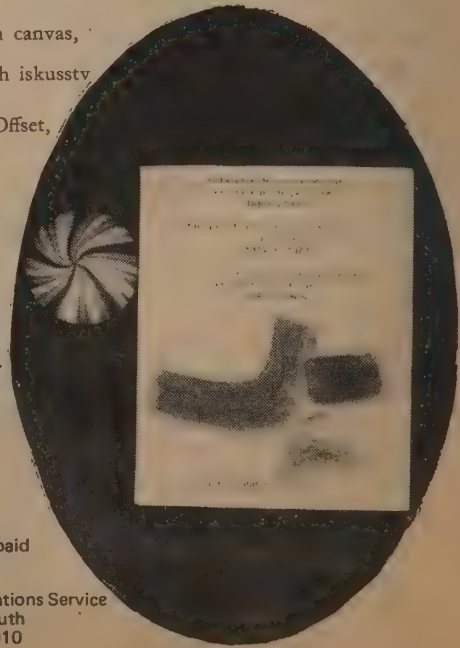

**The Modern Utopian**

Intentional communities by now constitute a realm of activity worth having a magazine. This is the magazine, and it is very good. Dick Fairfield, who edits *Modern Utopian*, clearly has knowledge of the traditions behind intentional communities as well as notions about their possible futures. His information network is broad, so reports of current communities are wide as well as deep. As we're going to press, *Modern Utopian* is organizing an information service for individuals wanting to find a community to suit them and vice versa.

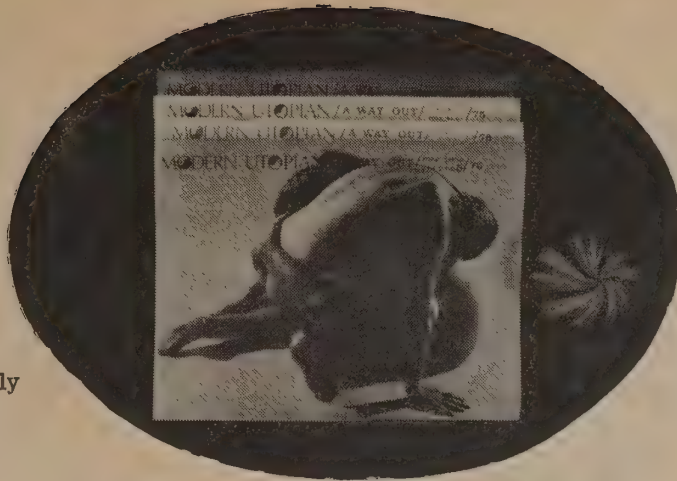

*The Modern Utopian / A Way Out*  
Dick Fairfield, ed.  
**\$4.00** for one year (bi-monthly)

from:  
The Modern Utopian  
2441 Le Conte Avenue  
Berkeley, California 94709

BEAUTIFUL NATURAL GRAIN CEREAL - PUT ALL THE GRAINS IN A LARGE CAN - MIX - THIS CAN WILL LAST 4 PEOPLE 2 MONTHS - EAT IT EVERY DAY AND STRENGTH WILL COME TO YOU - WARM MILK AND HONEY OVER IT - MILK AND SUGAR - COOK IT LIKE OATMEAL - FOR CAMPING ADD WATER

- 6 lbs. of OATS
- 6 lbs. WHEAT FLAKES
- 6 lbs. RYE FLAKES
- 3 lbs. WHEAT GERM
- 3 lbs. SUNFLOWER SEEDS
- 1 1/2 lbs. PUMPKIN SEEDS
- 4-6 lbs. RAISINS
- 3-5 lbs. DRIED FRUIT
- 3 oz. RICE POLISHINGS
- 2 oz. SOY LECITHEN
- 3 oz. GROUND CHIA SEEDS (USE BLENDER TO GRIND)
- 2 lbs. NUTS
- 1 lb. SOY FLOUR (OR CORN FLOUR)
- 3 lbs. SESAME SEEDS
- ORGANIC FAMILIA

ADD ANY SOFT CHEWABLE GRAINS YOU LIKE - KEEP ADDING TO IT - ALWAYS CHANGING

*eat and enjoy*

Starting a community farm is an incredibly difficult thing. We didn't fully realize this when we began. Setting up a new farm -- or rather, rehabilitating an old and neglected one -- was at least a season's work. Not to mention compensating for the work which should have been done the previous autumn.

**SOUTH AMERICA TAKE IT AWAY**

In the Chaco of Paraguay, fertile land is almost free, taxes are low, government interference is small. Some groups operating communities there, such as the pacifist Bruderhof, are granted a 10-year exemption from certain import tariffs, and permanent exemption from conscription by the military. *Immigrant Group Settlements in Paraguay* is a good book by a professor at Bethel College, a Mennonite school in Kansas.

The cool Brazilian highlands have less fertility than the Chaco, but the climate is better, as are the political and cultural environment. Land 300 miles north of the new capitol, Brasilia, sells for \$2 an acre, taxes are low, tariff exemptions are granted, and U.S. citizens have the same rights as Brazilians. Fall-out is less in the Southern Hemisphere. For free brochure on Brazil land, write Selig Bros. Real Estate Co., P.O. Box 26034, Indianapolis, Ind. 46224.

--Gerald Baker.

Dear Friends,  
I have spent over twenty years in what is now called the "Hippie Movement", living in short-lived communes based on an anarchistic freedom and long-lived communes based on religion, taking part in political activities such as CORE work in the early 50's and the political action era of the Sexual Freedom League, and writing for, drawing for and editing little literary reviews and underground newspapers. This experience has brought me, gradually and reluctantly, to certain conclusions that I'm pretty sure some of your readers will dispute, yet to me they seem inescapable. First, those communes based on freedom inevitably fail, usually within a year. Second, those communes based on authority, particularly religious authority, often endure and survive even against vigorous opposition from the outside world. (The best example of the strength of religious authoritarian communism is the monasteries and nunneries of the Catholic Church.) . . . How, then, can an intentional community possibly be superior to conventional society? If the intentional community hopes to survive, it must be authoritarian, and if it is authoritarian, it offers no more freedom than conventional society. I am not pleased with this conclusion, but it now seems to me that the only way to be free is to be alone.  
ORO, El Cerrito, Calif.

"Dinner begins with a song followed by a short meditative silence. Sometimes a record is played, or the news listened to. During dinner we report on the day's happenings at our jobs, things we've read, and discuss the news. Around dessert we share the day's mail. Then dishes and lunch-packing. Usually Connie and Rae--either separately or together--prepare dinner. The men usually either wash or rinse dishes. Connie packs lunches one week, Rae the next.

Planning, and even engineering, are therefore vital to the community. Skinner put an architect into the original planning group of his Walden II. Even if behavioral engineering is not to be a community concern, design must be considered, for defense against the state if for no other reason. But the real benefits are deeper. The established architecture of today, as exemplified by the code, has failed, and no longer creates viable environments for man. The new communities must design for a new life for man, and only through them can a new architecture of living and expanding be achieved.

Whether it is guarding a shrine, making electric music, applying Gestalt Therapy or feeding transient hippies, all viable communities have a conscious intent and meaningful function. As opposed to the lack of meaningful direction in today's American society, a conscious sense of purpose is the actualizing force if the community is to be more than a particularization of the social malaise it seeks to answer. Functions may change, sometimes with a rapidity which causes misunderstanding within the community; these changes, how they occur, and the control of change must be understood throughout the community.

**All Watched over by Machines of Loving Grace**

I like to think (and the sooner the better!) of a cybernetic meadow where mammals and computers live together in mutually programming harmony like pure water touching clear sky.

I like to think (right now, please!) of a cybernetic forest filled with pines and electronics where deer stroll peacefully past computers as if they were flowers with spinning blossoms.

I like to think (it has to be!) of a cybernetic ecology where we are free of our labors and joined back to nature, returned to our mammal brothers and sisters, and all watched over by machines of loving grace. The Realist



The Realist

*Community 41*

**The Realist Green Revolution**

If *The Realist* is the father of recent Underground newspapers, *Green Revolution* is the mother of community newsletters. Both are kind.

*The Realist*  
Paul Krassner, ed.  
**\$3.00** for 10 issues

*Green Revolution*  
Mildred Loomis, ed.  
**\$3.00** for one year (monthly)

from:  
The Realist  
595 Broadway  
New York, N.Y. 10012

from:  
School of Living Center  
Heathcote Road  
Freeland, Md. 21053

**Books On Community in the Heathcote School of Living Library**

- Island*, by A. Huxley, Bantam, 95¢.
- Walden Two*, by B. F. Skinner, Macmillan, \$1.95.
- Animal Farm*, by George Orwell, Signet, 75¢.
- California Utopian Colonies*, by R. V. Hinds, Yale Univ. Press, \$1.45.
- American Communities*, by R. V. Hinds, Corinth, \$1.45.
- Communitas*, by Paul Goodman, Vintage, \$1.25.
- Patterns of Anarchy*, by Krimmerman-Perry, Doubleday, \$1.95.
- Stranger in a Strange Land*, by R. A. Heinlein, Berkley, 95¢.
- Utopia*, by Sir T. More, Washington Square Press, 45¢.
- Harrad Experiment*, by Robert Rimmer, Bantam, 95¢.
- Compulsory Miseducation and Community of Scholars*, by Paul Goodman, Vintage, \$1.95.
- Go Ahead and Live!*, by M. J. Loomis, Philosophical Library (order from School of Living), \$4.00.
- Kibbutz, Venture in Utopia*, by M. E. Spiro, Schocken, \$1.95.
- Young Church in Action*, by J. B. Phillips, Macmillan, 95¢.
- To the Finland Station*, by Edmund Wilson, Doubleday, \$1.95.
- Brook Farm*, by L. Swift, Corinth, \$1.95.
- Brave New World*, by A. Huxley, Bantam, 75¢.
- Brave New World Revisited*, by A. Huxley, Perennial, 50¢.
- Republic*, by Plato, Modern Library, \$1.95.
- Looking Backward*, by E. Bellamy, Signet, 75¢.
- 1984*, by George Orwell, Signet, 75¢.
- Anthem*, by Ayn Rand, Signet, 60¢.

The Green Revolution



IV. America a nation so incredibly wealthy in 1968 that all morality is based on EXCESS: true American career counselors now ask only one question. "Do you want to produce garbage or do you want to collect garbage?" Industrialist or politician? Fishfarm or junkyard? The young people want no part of it, of course, what with garbage their natural matrix & medium. Produce it? Collect it? They want to fuck in it! The career counselors build marvelous constructions of seduction & mystery, they trans-substantiate symbol money into sex into power into death insurance into pleasure. But it's just THINGS, it's garbage, it's overflow & the young people know it. They throw the career counselor out the window. Who's going to collect the garbage? who knows? who cares? Let's use it to act out our fantasies, use it for unimaginable gratifications. The Realist

**Kibbutz: Venture in Utopia**

*This book is a straight forward description on one Kibbutz. It is the history, the problems, and the moral codes of a community which began in 1920 and has grown steadily since that time. Over a span of several generations it has grappled with problems, both economic and social, which are similar to problems faced by the community movement in the United States today.*

*The book examines critically and sympathetically the issues of property, marriage, education, comfort, and communication as it has been dealt with over the various periods of this Kibbutz.*

*While the book is of limited practical value as a how-to-do-it text, it offers a long term perspective on the difficulties and advantages of the community way of life.*

[Reviewed by James Fadiman]

This is a community which was founded, for the most part, by middle-class intellectuals who deliberately chose to be workers. . . . Instead of aspiring to "rise" in the social ladder, they aspired to "descend". . . . This Tolstoyan attitude toward work could be evolved, it is not hazardous to say, only by romantic, urban intellectuals.

...the moral postulates of Kiryat Yedidim. . . are important not only because they constitute the basis for the social structure of the Kibbutz, but because they provide a clue to an important premise of its living: the premise that life is serious. It is serious because the realization of these values, rather than immediate pleasure or self-seeking, is taken to be the purpose of living.

The notions of the movement were simple. They included a revolt against tradition; a love of nature; a love of nation, which seemed to consist of a vague mystique of the "folk"; self-expression; emphasis on the emotional aspect of life; the gospel of "joy in work."

But this emphasis on youth and on the equality that exists between the young and the old create a potentiality for a condition of inequality—an inequality in which the young assume the superior, and the old the inferior, status.



**Kibbutz: Venture in Utopia**  
Melford E. Spiro  
1956, 1963; 266 pp.

**\$2.25** postpaid

from:  
Schocken Books, Inc.  
67 Park Avenue  
New York, N.Y. 10016  
or  
WHOLE EARTH CATALOG

His job becomes more than a job and more than a way of making a living. It becomes a sacred task, a calling, in the religious sense of the term, dedicated, not to the greater glory of God but to the welfare of the group.

Instead of cooking and sewing and baking and cleaning and laundering and caring for children, the woman in Kiryat Yedidim cooks OR sews OR launders OR takes care of children for eight hours a day. She has become a specialist in one aspect of housekeeping. But this new housekeeping is more boring and less rewarding than the traditional type.

The kibbutz, it will be remembered, was originally conceived as a means to an end—the creation of the new man. Instead of the selfish, aggressive personality created by urban capitalism, there would emerge, as a result of the new social order, a kindly, altruistic personality. This end has not been achieved.

**Dune**

*A more recent Hugo Award winner than Stranger in a Strange Land, Dune is rich re-readable fantasy with clear portrayal of the fierce environment it takes to cohere a community. It's been enjoying currency in Berkeley and saltier communities such as Libre. The metaphor is ecology. The theme revolution.*

Too late, Jessica saw what was happening: the old woman was dying and, in dying, pouring her experiences into Jessica's awareness as water is poured into a cup. The other mote faded back into pre-birth awareness as Jessica watched it. And, dying-in-conception, the old Reverend Mother left her life in Jessica's memory with one last sighing blur of words.



**Dune**  
Frank Herbert  
1965; 544 pp.

**\$.95** postpaid

from:  
Ace Books, Inc.  
1120 Avenue of the Americas  
New York, N.Y. 10036

or most book stores.

**Groups Under Stress**

*This is a psychological study of the behavior of the three 10-man diver teams who spent 14 days 250 feet down in the Pacific in SEALAB II. The teams lived and worked in a 12'x57' cylinder under high hazard and high public visibility conditions. Their performances were exemplary, and this book seeks to 1) Explain the high performance level and 2) Improve methodology for such psychological studies in the field.*

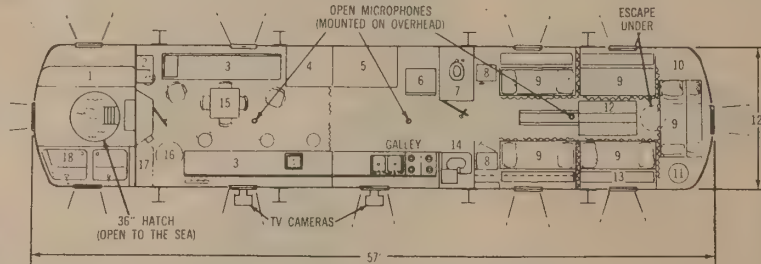

SEALAB II. Interior arrangement: Top removed looking down. 1. Swim gear stow. 2. TV. 3. Lab bench. 4. Fan room. 5. Electric power and light. 6. Reefer. 7. Head. 8. Locker. 9. 2-Berths. 10. Stow. 11. CO<sub>2</sub> can. 12. Table. 13. Bench. 14. Lav. 15. Table and chairs. 16. Water heater. 17. Can stow. 18. Tub and shower.

Subjects under high fear found the task significantly more enjoyable than those in a low fear state. It was reasoned that individuals resolved their dissonance about being in the threatening situation by concluding that it was really a rewarding and enjoyable experience.

The pattern of correlations is highly consistent and indicates that men from smaller towns reacted more favorably to the stressful conditions present.

On one occasion, a diver, in his squeaky Donald Duck voice, said "I have a message for the earth people. Fuck you!"

**42 Community**

*The book is technical, but it may be useful to groups who wish to improve their performances on one frontier or another, or to leaders who are interested in highly motivated teamwork, or to anyone wishing to analyse group doings.*

**COSTS AND REWARDS IN EXOTIC ENVIRONMENTS**

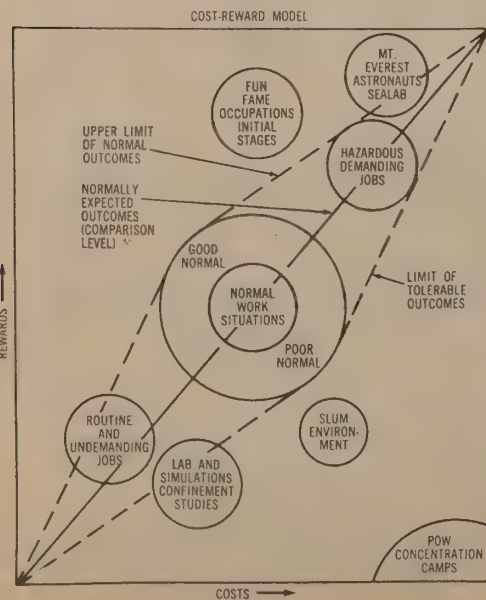

The question is why men are attracted to dangerous and demanding situations and why they make successful adjustments and perform well in highly stressful situations; correspondingly, why they reject, make poor adjustments and perform poorly in less stressful situations.

Then suddenly I realized that we made it. It was a real sense of well being, by golly, something like the Northwest Passage on a very tiny scale. We made it and even though it was only 250 feet from the habitat it was a real accomplishment. It was very pretty. It wasn't pretty as far as the scenic value, but it was beautiful in that it was what we were fighting to get to. The canyon rim.

People were nicer to me than they were on the surface. And I was nicer to them than I am on the surface. This SEALAB bunch, we have a hell of a high esprit de corps. We all respect each other. And this is something. Even though you hate a guy's guts, you respect him.

I personally was amazed at how well we did get along under such cramped conditions. It seemed to me everybody just went out of their way to be nice. You were bumping into people and knocking their stuff over and they were bumping into you and knocking your stuff over. It seems to me that everybody was just overly polite about it because they realized this condition existed and if dissension ever once did get started it would spread like wildfire.

Q. You censored your emotions?  
A. I censored my emotions. I don't know about the rest of the fellows. I sure did.

Firstborns reported significantly higher fear and lower well being while logging less diving time and making fewer sorties from SEALAB.

The significance of group support is well summarized in the sentiment expressed by a member of an Antarctic wintering over party who said: "If the rest of the guys get fed up and stop talking to you. . . that is worse than when they go off and leave you in a crevasse" (Rohrer, 1960)

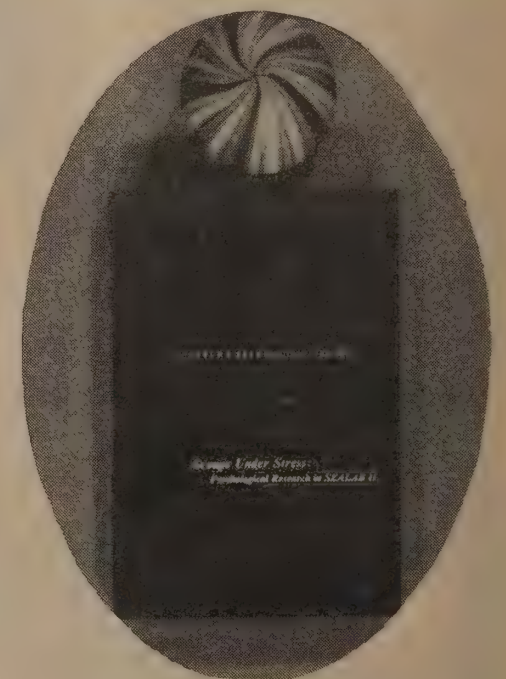

**Groups Under Stress—Psychological Research in SEALAB II**

Roland Radloff, Robert Helmreich  
1968; 259 pp.

**\$5.00** postpaid from:

Appleton-Century-Crofts  
440 Park Avenue South  
New York, N.Y. 10016  
or  
WHOLE EARTH CATALOG



## Government Publications

Relatively expensive access to phenomenally inexpensive information. If you or your group don't have money and do need technique, this may be your best source. Many of the government publications are outstanding. By and by we hope to have reviews of many specific good ones in the CATALOG. One drawback: the government grinds fine but very very slow—shipments take forever.

Inventions Wanted by the Armed Forces and Other Government Agencies: Cumulative Vol. 2 [List]. Natl Inventors Council, 1964. 62 p. Free from the Council. This hopeful inventory contains enough ideas to keep all of us hoping for some time.

Understanding the Atom Series. Atomic Energy Comm., 1963-67. Free from the Commission.

This extraordinarily handsome and informative group is published by the Division of Technical Information of the AEC. With some exceptions (recognizable by their titles), all of the group are intended to be as nontechnical as anything in this field can be. The entire series deals with every aspect of the subject, except the military; moreover, the series is aimed at several levels of understanding and background. Each of the titles is excellently illustrated. All carry reading lists. Since a great many of the titles have been issued very recently and were received too late by the compiler to permit individual annotation, only this broad introductory note is possible. The titles are recommended for school use and for the general public. The generous policy of the AEC, in making these very fine booklets freely available, deserves mention. Requests should be addressed to:

United States Atomic Energy Commission  
P.O. Box 62  
Oak Ridge, Tennessee 37830

Complete sets of the group are available free to schools and to public libraries, and to teachers who can make them available for reference or for use by groups.

Bark Canoes and Skin Boats of North America. E.T. Adney and H.I. Chapelle. Natl Museum, Bull. 230 (1964). 242 p. il. \$3.25  
SI 3.3:230

Of great historical interest. Also tells you (with plans) how to make these canoes.

Manual of Septic Tank Practice. Public Health Serv. 1960. 91 p. il. 40¢  
FS 2.6:Se 6/2

A fine detailed guide to proper maintenance and repair.

Controlling Mosquitoes in Your Home and on Your Premises. J.A. Fluno. Agr. Dept., Home and Garden Bull. 84 (1962). 12 p. il. 10¢  
A 1.77:84

## The Armchair Shopper's Guide

This cheerful book is an uncommonly practical compendium of access. Listed here are all of the major and many of the minor mail order shippers in the world. To a large extent the shippers carry items not available locally. Each source is very well described and compared with its competitors. The Armchair Shopper's Guide is more general than us, and geared to wealthier readers, but if you use the WHOLE EARTH CATALOG very much, you can almost certainly use the Shopper's Guide.



### The Armchair Shopper's Guide

Delphine C. Lyons  
1968; 218 pp.

**\$1.50** postpaid from:  
Essandess Special Editions  
Simon and Schuster, Inc.  
630 Fifth Avenue  
New York, N.Y. 10020  
or  
WHOLE EARTH CATALOG

Culpeper House, Ltd., 21 Bruton St., Berkeley Square, London W.1, England (catalog free): This distinguished firm is owned by the British Society of Herbalists, so its standards of purity and quality are high.

Here you will find one of the largest available collections of herbs and herbal preparations for all purposes, including many types and blends not easily available here, at prices generally well below American levels. Medicinal preparations include all kinds of herb teas and blends at about 40¢ to 50¢ per 2-ounce pack; tonics and remedies, pills and ointments (slippery elm and marshmallow cream is around 60¢; corn and wart paint costs 60¢). Among culinary products are flavorings, herbs and spices (including combinations and blends of their own), most costing about 50¢ per ounce, with a few exceptions such as cardamons and mace blades, which hit a top of around \$1.20 per ounce). Oils, vinegars, and such esoteric items as carrageen moss and tree bark are also available.

In addition, there's a line of herbal and floral perfumes and toiletries, with such delightful names as Blue Champak, Sussex Violets, Syringa, or Sweet Beans (which suggest, they say, "a beanfield after a shower of rain")—plus potpourris and pomanders and, if you're brave, herbal cigarettes at around 40¢ for a packet of twenty.

Stechert Hafner, Inc., 31 East 19th Street., New York, N.Y. 10003 (catalog free): Featured here are scientific, mathematical, and medical books, many of which are also published under the aegis of this distinguished house.

Then a really splendid source, The Guitar Maker, 8665 West 13th Ave., Denver, Colo. 80215 (brochure free) has do-it-yourself guitar, sitar, dulcimer, Irish harp, and balalaika kits, beginning as low as \$8 for the dulcimer, and \$9 for the balalaika. For faint hearts, they'll sell the finished instrument at from around two and a half to three times the price of the kit.

W. Atlee Burpee Co., 18th & Hunting Park Ave., Philadelphia, Pa 19132 (catalog free): Probably the best known of all American seed houses, Burpee's was founded in 1876, at a time when America imported almost all its seeds from Europe. Mr. Burpee—and, later, his famous cousin Luther Burbank—started a tradition of creating new flowers and vegetables through scientific methods, which the firm continues today under his son's direction. Every year several new varieties of plants are offered.

The familiar catalog with its handsome full-page color illustrations offers a comprehensive listing of seeds—about one-third are vegetables and the rest are flowers—plus garden supplies. A special feature is a page listing types of flowers most appropriate for various purposes, including "easy-to-grow" types for the amateur or unlucky gardener.

Every gardener, from the strictly amateur to the case-hardened professional, knows about Hyponex all-purpose plant food. However, some people don't know that the same firm, Hydroponic Chemical Co., Copley, Ohio 44321 (brochure free) manufactures nine other plant food formulas, as well as special foods for particular plants. Don't let the firm's name fool you. Although their plant foods are, of course, useful in soilless gardening, they're meant for all kinds of plant culture, indoors and out. In addition, Hydroponic offers a whole line of garden and houseplant supplies, many of which are difficult to find locally. It's the only place I know of where you can get sand in small quantities—quarts are less than a dollar postpaid.

† Merchandise shipped postage free.

## How to Get 20% to 90% Off on Everything You Buy

Well, yeah. Except the book smells of self-improvement. Somehow if you beat your neighbor for bargains it makes you a better person and this a better world. Sure.

There's nothing unique in this book, but all the corner-cutting techniques are here. The main advice is: trade you, services or talents or whatever for what would otherwise cost you money. Most of the information won't be new to you, but the ideas that are will more than save you the price of the book—if you take the trouble, which all bargain-finding comes down to.

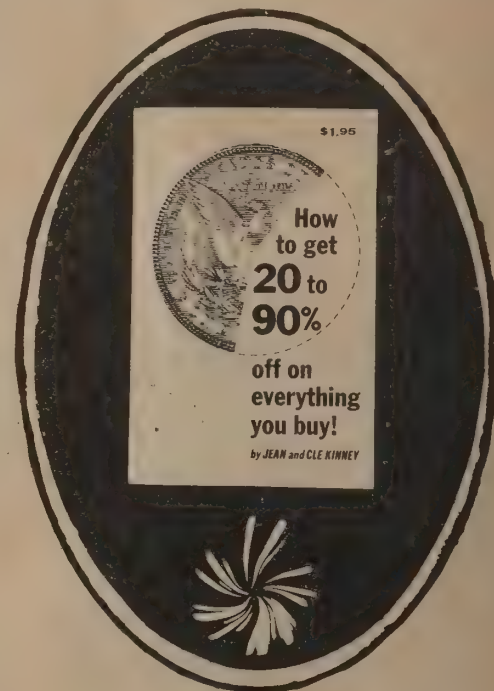

Here are five don'ts to keep in mind when bargaining:

1. Don't try to bargain at a chain store. The store has its prices set at the central office.
2. Don't try to bargain with a clerk in a privately owned store. Only the owner or a strong head of a department is a decision maker.
3. Don't try to cut the price of merchandise that has a set price in all stores. These "fair trade" items have prices set at the manufacturer's home office. Store owners who fiddle with these prices can lose their franchise.
4. Don't pretend to be an expert when buying from someone who knows more about the merchandise than you do.
5. Don't knock the merchandise!

### How to Get 20% to 90% Off on Everything You Buy

Jean and Cle Kinney  
1966; 255 pp.

**\$1.95** postpaid from:  
Parker Publishing Company, Inc.  
Prentice-Hall, Inc.  
Englewood Cliffs, N.J. 07631



### A Popular Guide to Government Publications

W. Philip Leidy  
1968; 363 pp. 3000 items

**\$12.00** postpaid from:  
Columbia University Press  
Stock Department  
Irvington-on-Hudson, N.Y. 10533  
or  
WHOLE EARTH CATALOG

Home Poultry Flock. Agr. Dept., Leaflet 497 (1965). 8 p. il. 5¢  
A 1.35:497

A simple guide for the small scale producer.

Wood Handbook: Basic Information on Wood as a Material of Construction, with Data for its Use in Design and Specification. Agr. Dept., Agr. Handbook 72 (1955). 528 pp. il. \$2.25  
A 1.76:72

A good deal of the information here will be of interest to anyone working with common woods for building or carpentry.

Recipes [Navy—Marine Corps Recipe Serv.]. Navy Dept., Supplies and Accounts Bur., 1963. 738 cards, 5" x 8". \$8.25 per set.  
D 212.2R 24/963

Meant, of course, for very large servings indeed.

Anthropology as a Career. W.C. Sturtevant. Smithsonian Inst., 1963. 20 p. 23¢. Purchase from the Institution.

Family Guide: Emergency Health Care. Civil Defense Off., 1963. 60 p. il. Free from the Office.

The advice here is not intended to substitute for professional medical care; covering a wide range of illnesses and ailments, it tells you what to do in emergencies—everything from a toothache to childbirth.

Farming Terraced Land. P. Jacobson and W. Weiss. Agr. Dept., Leaflet 335 (1961) [1963]. 14 p. il. 15¢  
A 1.35:335

Excellent illustrated guide to techniques involved.

44 Community

**Innovator**

The people who produce and read *Innovator* are very dubious about Society's chances just now. They expect an *Atlas Shrugged* sort of collapse, and they are preparing for it by defining and becoming proficient at a 'libertarian' way of life: philosophic and bodily survival amid order or chaos. Recently, *Innovator* has shifted emphasis toward bodily survival; carrying information on self-protection, nomadic techniques, community techniques, secure communications, and so forth.



*Innovator* is published quarterly. *Free Trade*, a supplement devoted to ads and correspondence, comes out monthly. [Suggested by Tom Duckworth]

**\$1.00** *Innovator* for one year.  
**\$4.00** *Innovator* and *Free Trade* for one year.

from:  
 Box 34718  
 Los Angeles, California 90034

**The Retreater's Bibliography**

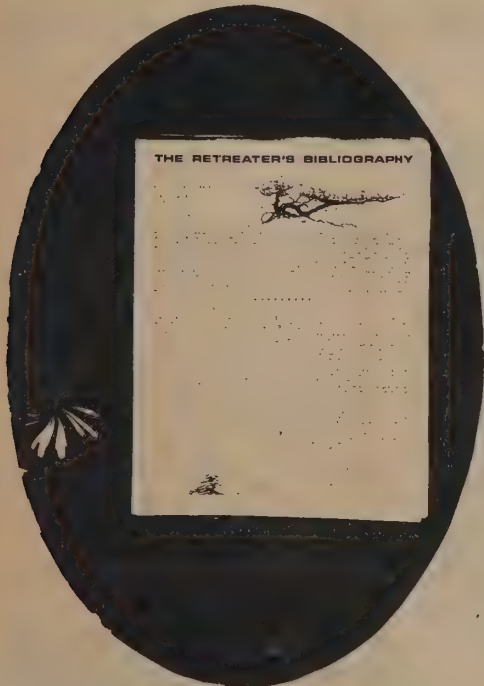

Listed here are titles, costs, sources, and some capsule reviews of books relevant to living outside a system. Some of the categories overlap with *WHOLE EARTH CATALOG* listings, and we've found that sometimes we have more complete information, sometimes the Stephens do.

*Retreater's* categories include: *Camping and Survival, Finding a Proper Location, Food Supply and Domestic Animals, Building Your Own Home, Medicine, Education and Retreat Library, Recreation, Protection and Hunting, Land Mobility, Water Mobility, Waste Disposal, and General.*

*The Retreater's Bibliography*  
 Don and Barbie Stephens  
 1968; 18 pp.

**\$9.50**

from:  
 Atlantis Enterprises, Ltd.  
 5020 El Verano Ave.  
 Los Angeles, California 90041

**The Book of Survival**

*The Book of Survival* is hilarious to read aloud, which is fine, because the admonitions sink in via the laugh, and, next time you're running from an enraged bull, you remember about flinging down your jacket.

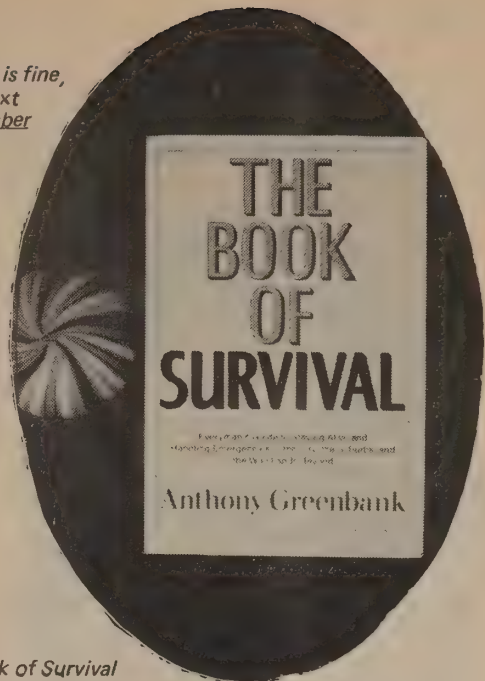

*The Book of Survival*  
 Anthony Greenbank  
 1967; 223pp

**\$5.98** postpaid from:  
 Harper and Row  
 49 East 33rd Street  
 New York, NY 10016

or **WHOLE EARTH CATALOG**

**CREATURES FROM OUTER SPACE (STEPPING FROM FLYING SAUCER)**

Avoid rapid forceful movement.  
 Use no shrill sounds.  
 Breathe quietly.  
 Avoid giving a direct menacing gaze.

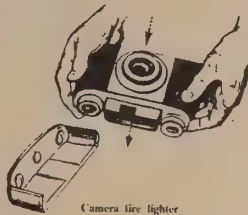

Camera fire lighter

**DOGS**

Ordinary village dog in other countries is often dangerous. Semi-starved and savage, its bite can be fatal (if dog has rabies). Signs—glazed eyes/foaming mouth/staggering.

Stone them to keep at bay if they attack you.

With other big dogs try the following deterrents, in this order:

- (a) Hit on nose **HARD** and **FAST**.
- (b) Brace forearm in front of you, offering it to dog. When seized jam it to back of jaws and instantly bring over your other arm (palm flexed and facing floor) so bony edge of forearm forces into back of dog's neck as you force the head backwards and over the arm with a quick jerk. Rolling action.

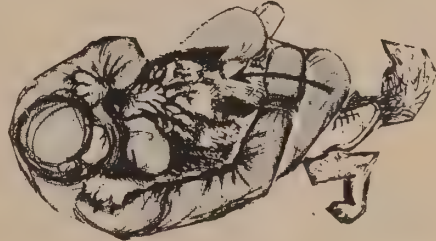

Wolf fight

When lying on the ground and being kicked try to keep rolling, shielding parts being kicked with arms. **BUT** always protect head as priority. Clasp base of skull with both hands, bring wrists across ears and side of head and press elbows together. Bring knees up, crossing ankles to save genitals.

In all attacks it pays to shout/gasp/yell more than you need: Feign pain. Especially when on receiving end (lying on ground and being kicked). Attacker may be satisfied sooner when you appear in agony.



Kidney and head protection

**PRECOLLISION ACTION WHEN NOT STRAPPED IN**

1. DO OPPOSITE OF NATURAL INSTINCT TO PUSH AWAY FROM CRASH
2. FLING YOURSELF TOWARDS POINT OF IMPACT...
3. WRAPPING ARMS ROUND HEAD...
4. TWISTING SIDEWAYS AND LYING WITH FLANK ACROSS FRONT



Rope climbing using friction knots.

**FIGHTING DRUNK**

Humor.

If involved in brawl, drunks can offer astoundingly strong grip. Hit hard in stomach and this may make him sick.

**EMRGENCY CHILDBIRTH**

Happens anytime. Don't panic. Not unique situation. Let nature handle it with you helping it along.

Above all . . .

1. DON'T PULL BABY OR ITS CORD OR AFTERBIRTH ATTACHED TO OTHER END OF CORD.
2. TIE CORD AS SOON AS BABY IS DELIVERED.
3. CUT CORD ONLY IF NO HELP LIKELY. IF HELP ON WAY, TIE CORD BUT LEAVE AFTERBIRTH ATTACHED.
4. KEEP BABY WARM. PLACE BETWEEN MOTHER'S LEGS...



Survival still

**Nomadics 45**

**The Survival Book**

*The Survival Book is the best we've seen of the military survival manuals. It was prepared in the late '50s by Allen, Nesbitt and Pond for the Air Force (downed pilots particularly). Mr. Allen tells us that if we customers hassle the publishers, Van Nostrand, they'll come out with a paperback edition.*

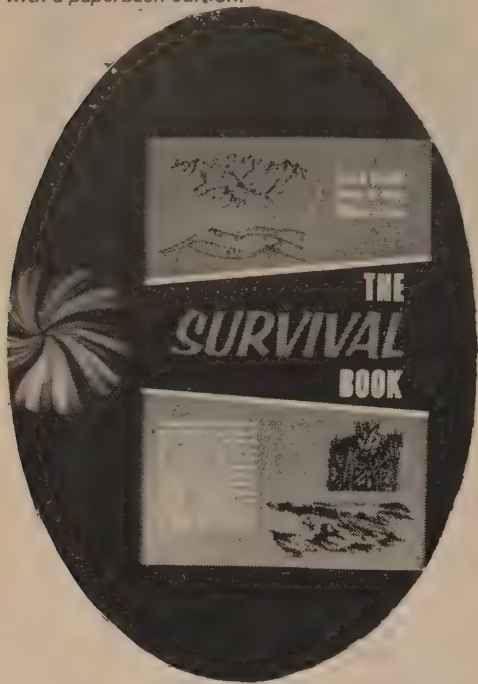

The fruit of all cactus plants is good to eat. Some cactus fruit is red, some yellow when ripe, but all are soft. Any of the flat leaf cactus plants like the prickly pear can be boiled and eaten as greens (like spinach) if you peel or cut off the spines first.

**The Survival Book**

Paul Nesbitt, Alonzo Pond, William Allen  
1959; 338pp

**\$8.50** postpaid from:  
D. Van Nostrand Company, Inc.  
120 Alexander Street  
Princeton, NJ 08540  
or **WHOLE EARTH CATALOG**

One of the authors once gave a 50-cent Swiss jackknife to a Tuareg noble in the Sahara. Later he received courtesies out of all proportion to the demands of hospitality. Finally the noble explained. "When you first came here you gave me a knife that closes. All my life I have wanted a knife that closes. You are my friend. Anything I have is yours."



Fig. 7-1. Major Deserts of the World.

**DO'S AND DON'TS FOR THE TRAVELER IN ARABIAN DESERTS**

Here are a few of the most important don't's. In general they apply to the deserts everywhere.

- Don't reprimand an offender in front of other people.
- Don't draw sand pictures or maps with your foot—stoop down and draw with your right hand.
- Don't swear at a native.
- Don't expose the soles of your feet to others. Sit tailor fashion or on your heels.
- Don't ask about a man's wife.
- Don't throw a coin at a man's feet. That is insulting.
- Don't try to gamble. It is forbidden.

And here are a couple of Do's worth remembering.

- Do have patience when dealing with desert people.
- Do act friendly.

Deserts are quite healthy places. Dry air is not favorable to bacteria. Wounds usually heal rapidly in the desert, even without treatment. Except in some oases of the Sahara, malaria does not exist in the desert. Venereal diseases, however, are prevalent in both the Gobi and Sahara, and are much more common in Mongolia than in Africa. But unless you lose all sense of proportion as to your immediate situation, you will not become involved in this aspect of desert life.

Give careful thought to the selection of equipment you will carry on the walkout. A 50-pound pack is a heavy load; 20 to 30 pounds is much more reasonable. The four most important equipment items for jungle travel and living off the land are the machete, the compass, the first-aid kit, and the parachute.

The highways of the jungle are the trails and the streams; use them if you have to do any extended travelling. The beds of small streams are usually used as trails by the natives, because it is easier to wade in shallow water than to push through thick undergrowth.

TABLE 1-1

**CONDITIONS AT WHICH EXPOSED FLESH FREEZES**

Wind Velocity, MPH	Temperatures, °F
43	20
26	15
18	10
14	5
13	-0
9	-5
7	-10
6	-15
5	-20
4	-25
3	-30
2	-40

**EXPECTED DAYS OF SURVIVAL AT VARIOUS ENVIRONMENTAL TEMPERATURES AND WITH VARYING AMOUNTS OF AVAILABLE WATER**

	Max. daily in shade temperature, °F	Available water per man, U.S. quarts					
		0	1	2	4	10	20
NO WALKING	120	2	2	2	2.5	3	4.5
	110	3	3	3.5	4	5	7
	100	5	5.5	6	7	9.5	13.5
	90	7	8	9	10.5	15	23
	80	9	10	11	13	19	29
	70	10	11	12	14	20.5	32
	60	10	11	12	14	21	32
50	10	11	12	14.5	21	32	
WALKING AT NIGHT AND RESTING THEREAFTER	120	1	2	2	2.5	3	
	110	2	2	2.5	3	3.5	
	100	3	3.5	3.5	4.5	5.5	
	90	5	5.5	5.5	6.5	8	
	80	7	7.5	8	9.5	11.5	
	70	7.5	8	9	10.5	13.5	
	60	8	8.5	9	11	14	
50	8	8.5	9	11	14		

**Survival Arts of the Primitive Paiutes**

*Survival Arts of the Primitive Paiutes is a rare book: it shows in exhaustive well-illustrated detail how one tribe managed its daily survival. I wish someone would do a similar book on Eskimos.*



**Survival Arts of the Primitive Paiutes**

Margaret M. Wheat  
1967; 177pp

**\$10.00** postpaid

from:  
University of Nevada Press  
Reno, Nevada

or **WHOLE EARTH CATALOG**

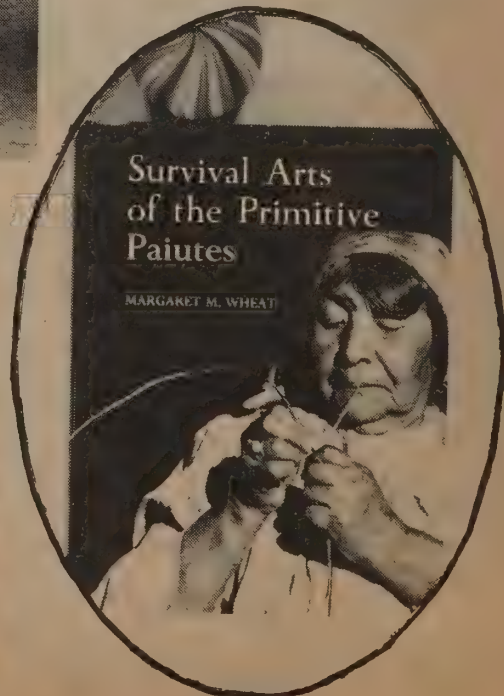

When the boat was completed, Jimmy stepped in the center to form a deeper hollow. The finished boat was eight-and-a-half feet long but so light that it could easily be lifted with one hand.

Shoveling hot coals from the breakfast fire onto the small, brown pinenuts in the winnowing tray, she began immediately to bounce and turn them, keeping them in constant motion to protect the basket from becoming scorched.

When the nuts hissed and popped somewhat like popcorn, she knew they were cooked. This first roasting leaves the meat soft and translucent.

To play the game, two people on one side each concealed a pair of sticks or "bones" within their closed fists. One bone of each pair was plain, the other ornamented. The guesser on the opposing team had to choose in which hands the unornamented sticks were hidden. If the guess were correct, his side was awarded a tally stick. If not, his side lost a stick. The side winning all ten tally sticks claimed all the bets. The singers opposing the guesser shouted, waved, and beat the logs to confuse him, but he sat quietly, apparently oblivious to the distractions, concentrating on his choice. It is remarkable how often a good guesser won. Winners were never congratulated, nor were losers ever consoled. The game is still played in the Great Basin with stakes often running into hundreds of dollars.

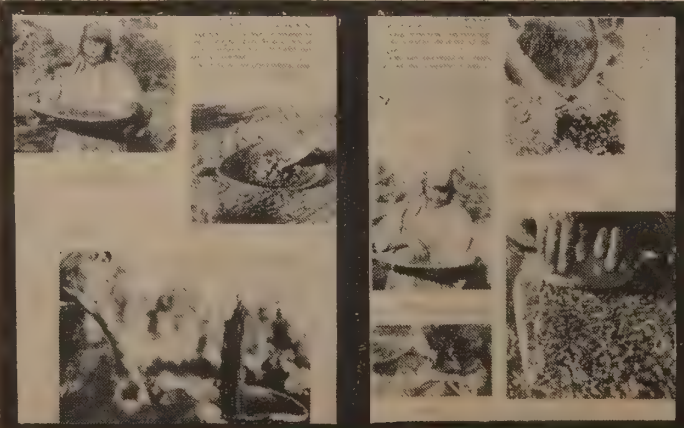

46 Nomads



**Camping and Woodcraft**

When friend Roland goes camping he takes his Bible and his Kephart. I generally leave home the Bible.

How could anything written in 1916 still be so useful? One, it is a masterwork. Two, in Kephart's day when you went camping you really disappeared, so there's a valid nostalgia factor. But the main thing is, the book survives on its wealth of specific practical lore. Game: find the information that is outdated, sort it from the information that is correct and available nowhere else.

**Camping and Woodcraft**  
Horace Kephart  
1917, 1921, 1967; 479 pp.  
**\$6.95** postpaid

from:  
The Macmillan Company  
866 Third Avenue  
New York, N.Y. 10022  
or  
WHOLE EARTH CATALOG



The charm of nomadic life is its freedom from care, its unrestrained liberty of action, and the proud self-reliance of one who is absolutely his own master, free to follow his bent in his own way, and who cheerfully, in turn, suffers the penalties that Nature visits upon him for every slip of mind or bungling of his hand. Carrying with him, as he does, in a few small bundles, all that he needs to provide food and shelter in any land, habited or uninhabited, the camper is lord of himself and of his surroundings.

Men working hard in the open, and exposed to the vicissitudes of wilderness life, need a diet rich in protein, fats (especially in cold weather), and sweets. This may not agree with theories of dieticians, but it is the experience of millions of campaigners who know what their work demands. A low-protein diet may be good for men leading soft lives, and for an occasional freak outdoorsman, but try it on an army in the field, or on a crew of lumberjacks, and you will face stark mutiny.

**Muddy Water.**—I used to clarify Mississippi water by stirring cornmeal in it and letting it settle, or by stirring a lump of alum in it until the mud began to precipitate, and then decanting the clear water. Lacking these, one can take a good handful of grass, tie it roughly in the form of a cone six or eight inches high, invert it, pour water slowly into the grass, and a runnel of comparatively clear water will trickle down through the small end.

**Trees and Lightning.**—I have never seen, nor heard of, a beech tree that had been struck by lightning, although beeches are plentiful on many battle-scarred mountains where stricken trees of other species can be noted by the score.

One glance at a camper's fire tells what kind of a woodsman he is. It is quite impossible to prepare a good meal over a heap of smoking chunks, a fierce blaze, or a great bed of coals that will warp iron and melt everything else.

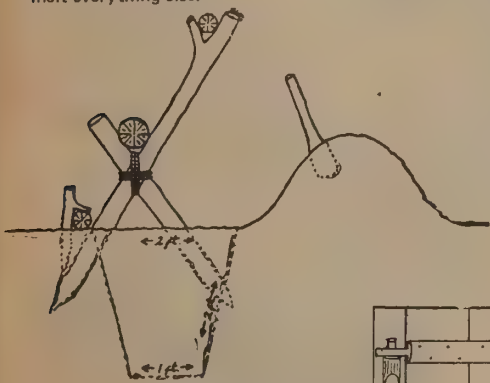

Fig. 113—Latrine

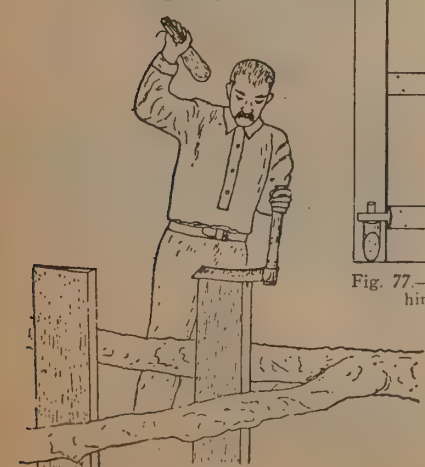

Fig. 49.—Splitting with a Froe

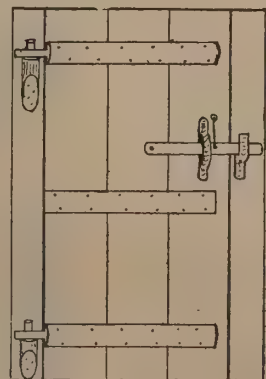

Fig. 77.—Cabin door (wooden hinges and latch)

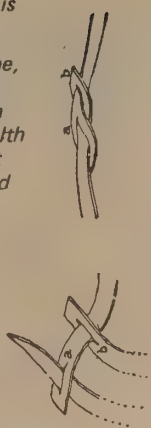

Fig. 185.—Splicing things



Fig. 68.—A Masked Camp

In Alaska, all animals leave for the snow-line as soon as the mosquito pest appears, but the enemy follows them even to the mountain tops above timber-line. Deer and moose are killed by mosquitoes, which settle upon them in such amazing swarms that the unfortunate beasts succumb from literally having the blood sucked out of their bodies. Bears are driven frantic, are totally blinded, mire in the mud, and starve to death. Animals that survive have their flesh discolored all through, and even their marrow is reduced to the consistency of blood and water. The men who penetrate such regions are not the kind that would allow toil or privation to break their spirit, but they become so unstrung from days and nights of continuous torment inflicted by enemies insignificant in size but infinite in number, that they become savage, desperate, and sometimes even weep in sheer helpless anger.

**BENDING WOOD.**—Small pieces of green wood can be bent to a required form by merely soaking the



Fig. 54.—Spanish Windlass (for bending wood)

pieces for two or three days in water, but if it is desired that they should retain their new shape, they should be steamed.

Rabbits are unfit to eat in late summer, as their backs are then infested with warbles, which are the larvae of the rabbit bot-fly.

**Green Corn.**—If you happen to camp near a farm in the "Roasting-ear" season, you are in great luck. The quickest way to roast an ear of corn is to cut off the butt of the ear closely, so that the pith of the cob is exposed, ream it out a little, impale the cob lengthwise on the end of a long hardwood stick, and turn over the coals.

**Skilligalee.**—The best thing in a fixed camp is the stock-pot. A large covered pot or enameled pail is reserved for this and nothing else. Into it go all the fag-ends of game—heads, tails, wings, feet, giblets, large bones—also the left-overs of fish, flesh and fowl, of any and all sorts of vegetables, rice, or other cereals, macaroni, stale bread, everything edible except fat. This pot is always kept hot. Its flavors are forever changing, but ever welcome. It is always ready, day or night, for the hungry varlet who missed connections or who wants a bite between meals. No cook who values his peace of mind will fail to have a skilly simmering at all hours.

A woodsmen, on the contrary, walks with a rolling motion, his hips swaying an inch or more to the stepping side, and his pace is correspondingly long. This hip action may be noticed to an exaggerated degree in the stride of a professional pedestrian; but the latter walks with a heel-and-toe step, whereas an Indian's or sailor's step is more nearly flat-footed. In the latter case the center of gravity is covered by the whole foot. The poise is as secure as that of a rope-walker.

It is not nearly so much the "make" of rifle as the load it takes that determines the gun's shooting qualities. So, choose first a cartridge, then a gun to handle it.

A more highly prized kinnikinick is made from the leaves of the bear-berry or uva-ursi (*Aretostaphylos-uva-ursi*), called sacaommis by the Canadian traders, who sell it to the northern Indians for more than the price of the best tobacco.

**Light Weight Camping Equipment and How to Make It**

It's all here: design, patterns, assembly techniques, light weight materials, and sources of the materials. Because of good information on what's needed for various environments, it's a useful book even if you aren't making your own stuff. An indispensable book if you are.

[Suggested by Roland Jacopetti]

**Light Weight Camping Equipment**

Gerry Cunningham  
Margaret Hansson  
1959; 130 pp.

from:  
Gerry  
PO Box 5544  
Denver, Colorado 80217

**\$2.50** 1 lb. 2 oz shipping weight

**Parka**

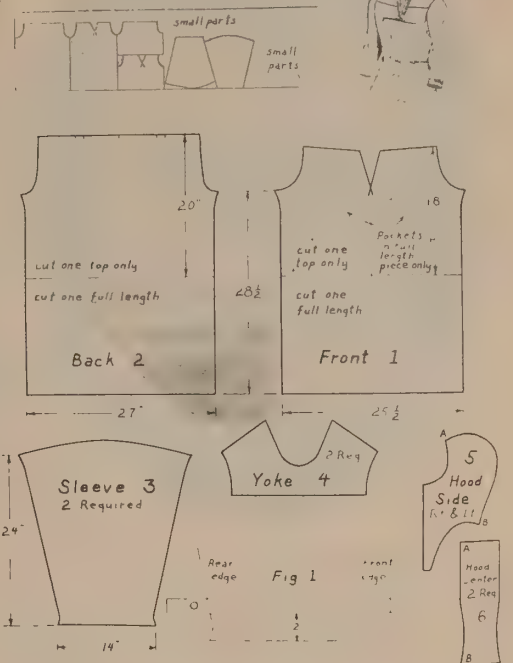

Here is a list of sources of supply for the materials described. Following the addresses, the suppliers will be listed separately under various materials headings with the specific items they can supply.

- GERRY PO Box 5544, Denver, Colorado 80217
- HOLUBAR, 1215 Grandview, Boulder, Colorado—catalog available
- RECREATIONAL EQUIPMENT INC., 523 Pike St., Seattle 1, Wash. catalog available
- THOMAS BLACK & SONS, Scottish Industrial Estate, Port Glasgow, Renfrewshire, Scotland—catalog available.
- TRAILWISE (The Ski Hut), 1615 University Ave., Berkeley 3, California—catalog available.
- SEARS ROEBUCK—local store or mail order catalog
- MONTGOMERY WARD—local store or mail order catalog
- Tent and awning suppliers, yard goods shops, leather wholesalers, luggage shops, marine outfitters, sailmakers, shoe manufacturers and repair shops, harness and saddle shops, mattress and bedding manufacturers, army surplus stores, hardware stores, dry goods departments, handicraft shops, notions departments.

**Backpacking**

A well-regarded inexpensive book on backpacking, kept fairly up to date.

[Suggested by Roland Jacopetti]



**Backpacking**  
R.C. Rethmel  
1964; 120 pp.

**\$2.15** postpaid

from:  
The Alamogordo  
Printing  
Company  
Alamogordo,  
New Mexico

# Bean's Maine Hunting Shoe

The Bean catalog is the model for the **WHOLE EARTH CATALOG**. Mr. Bean had a directness and integrity that shows through his catalog, his products, his service. The catalog has excellent items, especially outdoor clothing. An uncommonly pleasant company to do business with.

catalog Free from: L.L. Bean, Inc., Freeport, Me. 04032



Mr. Bean first developed this boot in 1912. He was tired of coming home with wet and sore feet from wearing the heavy leather woodsman boots then in common use. Rubber boots were clammy feeling and too clumsy for all day walking. He decided to combine lightweight leather tops with all rubber bottoms, incorporating the best features of both types of footwear and doing away with the disadvantages. He called his new boot the Maine Hunting Shoe.

The practical advantages of this design were readily apparent to hunters and woodsmen. For bare ground walking it was light in weight, snug fitting, had a cushioned innersole and a non-slip, chain tread outsole. For wet going and walking on snow, the waterproof bottoms were ideal. Mr. Bean invented the split backstay to eliminate chafing and by keeping all parts as light and flexible as possible he had a boot that could be used all day in perfect comfort. The Maine Hunting Shoe was an immediate success.



	6 in.	8 in.	10 in.	12 in.	14 in.	16 in.	
Elk-tanned:	\$16.00	\$17.00	\$19.00	\$20.00	*	*	Postpaid
Oil grain:	\$16.85	\$17.85	\$19.85	\$20.85	\$23.85	\$26.85	

\*14 in. and 16 in. heights come with brown oil grain tops only. For lacing hooks add 50c.

# Bean's Folding Sled

Strong enough to hold 1,000 pounds, yet weighs only 10 pounds. Originally designed to haul game into camp but is very useful for ice fishing, skating parties and for carrying food and equipment to camp. In case of accident may be used for hauling injured.

Length 48", width 18 1/2", height 6 1/2". Dimensions when folded — length 65 1/2" x 8 3/4" x 5".

May be carried on back seat of automobile.

When not in use may be folded and hung on wall, taking very little space. Price. \$16.00 postpaid.



## Recreational Equipment

Organized as a cooperative in 1938, Recreational Equipment, Inc. has grown to a membership of 79,000, with 2000 items listed in their catalog. These items are available at prices well below any other suppliers (with the exception of a few items, we're told). They are particularly strong on mountaineering equipment. Lifetime membership costs \$1.00.

(Suggested by Roland Jacopetti)

from: Recreational Equipment, Inc. 1525 Eleventh Avenue Seattle, Washington 98122



Nomadic 48



**Adjustable Tent Poles.** Lightweight aluminum 2-piece telescoping poles. Folding down to average 4'. Ideal for tarps, tent awnings, etc.

E459C22	6' length, 18 oz.	1.85
E459C23	7' length, 20 oz.	2.10
E459C24	8' length, 22 oz.	2.45

**[C] Collapsible P-88 Tent Pole.** A four-section pole used with McKinley or Camper tents. Extends to 88" and collapses to 25" x 1 1/8" diameter. Weight 2 3/4 oz.

E657C4 4.95

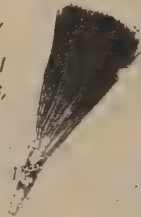

### CO-OP CRUISER PACKS

The Cruiser contoured aluminum frame is the latest improvement in pack frames incorporating the strength and lightness of aluminum plus a contoured shape that makes backpacking a pleasure. We have designed a packbag made from a special 9 oz. waterproof nylon that is the heaviest weight pack cloth available, and is exclusive with us.

**Cruiser Pack Frame.** Made from tubular aluminum with heavy web back bands, padded shoulder straps and waist strap. Exclusive with us is the extra top bar for more rigidity.

Senior size frame, 15" wide, 31" long, for most adults, 2 3/4 lbs.

C546A6 10.00

**Senior Co-op Cruiser Bag.** The bag is 6" x 15" x 21" deep with a center pocket 1 1/2" x 10" x 8" deep, two side pockets 2" x 5" x 6" deep and two other pockets on the side which are 2" x 5" x 11" deep. All Cruiser bags attach to the frame by two cups suspended on the top rung and by two straps at the bottom, and are doubly reinforced at all stress points.

C678A10 Red or Sage nylon, 1 3/4 lbs. 12.95

C678A11 Red or O.D. cotton, 2 lbs. 9.95

**[C] Velcro Tape Closure.** The pull-apart closure that takes the place of a zipper. Although sold separately, both halves are needed for a closure. Grey color.

N315B14	1" hook, per foot	.35
N315B15	1" pile, per foot	.35
N315B16	2" hook, per foot	.70
N315B17	2" pile, per foot	.70

**Mountaineering Medicine,** a concise, handy guide to treatment of all sorts of ills and injuries in the mountains. By Dr. Fred Darville.

R389A75 1.00



### DYNAMIC ROPE

In recent years, the Europeans have developed a new climbing rope using a solid core of parallel strands of nylon surrounded by a woven sheath. This has been found to be very strong and easy to handle, having less tendency to kink in use. Called "Dynamic," it has an elasticity of about 80% at rupture, thus giving greater protection to the climber during a fall. The tensile strength is, however, somewhat less. This new rope has been given the stamp of approval by the U.I.A.A. (Union International des Associations d'Alpinisme), who, through their testing, have set standards for maximum safety to climbers. Note: 9mm rope is recommended for double-line use.

**[B] Mammut Dynamic Rope.** Swiss made, red.

9mmx120', 5 lbs.	B218A22	20.95
9mmx150', 6 lbs.	B218A21	24.95

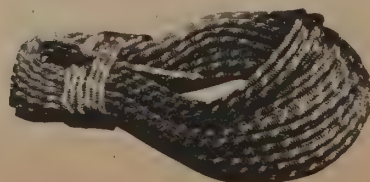

### BULK PACKED FREEZE-DRIED FOOD

These larger quantities are suitable for expeditions. They must be re-sealed after only partial use to prevent spoiling.

**3 Quarts in Polybags.** Packed in cardboard cartons.

Corn, whole kernel, 16 oz.	K404A13	2.95
Peas, garden, 16 oz.	K404A14	3.50
Strawberries, 8 oz.	K404A15	5.50
Peaches, 8 oz.	K404A16	4.50
Beef Patties, #10 tin, 1 3/4 lbs.	K404A33	9.75

### #2 1/2 SEALED TINS

Alaska King Crab, net weight 4 3/4 oz. cooked.....K404A18 4.25



**[A] Sierra Cup.** Stainless steel, all-time favorite, wire handle, nesting, 3 oz.  
H449C37 1.00

**[B] Nesting Aluminum Cup.** With folding wire handle, Swiss made.  
3" diameter H206C22 .55  
3 1/2" diameter H206C23 .60

**[C] Bob Lane Cup.** Unique stainless cup, folds completely flat, does not leak, sturdy, weight only 3/4 oz.  
H536C7 1.25



Mount Kennedy, 14,000'. In 1965, our men and equipment were on the first ascent of the peak named for the late President, and on the subsequent mapping research done in the area.

L.L. Bean cont.

## Heavy Duty Belt

For hunters, fishermen and guides who require a solid leather belt for hard service. A fancy dress belt looks out of place on heavy hunting pants.



Made of high grade genuine cowhide with brass plated buckle  
Two colors: Light Tan. Black. Sizes 24 to 48.

Width 1 1/4". Price, \$1.80 postpaid.



vented leather insole. Firm heel counters, bellows tongue and elasticized laces for snug, non-binding fit.

Color, Sand Suede.

**Men's Ankle Height (above):**

Sizes 7 to 13. Whole and half sizes. (No size 12 1/2.)

Medium width.

Price, Men's Ankle Height Wallabees, \$21.95 a pair postpaid.

**Ladies' Low Cut (at right):**

Sizes 5 to 10. Whole and half sizes.

Medium width.

Price, Ladies' Low Cut Wallabees, \$19.95 a pair postpaid.

## Wallabees

(For Men and Women)

A new design by Clarks of England for complete walking comfort. Fit perfectly on the first wearing.

Special "Nature Form" lasts fit the natural contours of the feet. Do not restrict them in any way yet provide firm support.

Glove leather uppers of full grained European calfskin suede. Extra thick, soft and supple. Wedge type soles of Plantation crepe rubber have a resilience not found in synthetic crepes.

Moccasin construction with hand sewed toe piece. Molded, orthopedic-type arch support enclosed in sponge rubber and

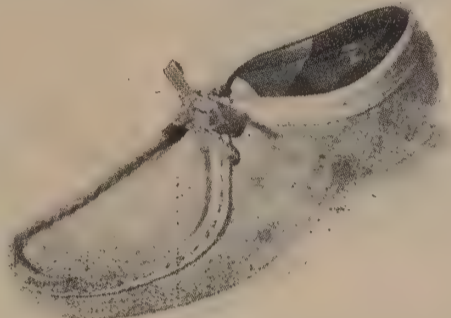

## Bean's Insulated Boot Pant

Constructed same as Mackinaw of 21 oz. wool lined with quilted, foam rubber insulation. Extra warm, not bulky and hard wearing. Four deep, strong pockets with flaps on rear ones. Watch pocket, riveted suspender buttons and knit cuffs. Weight about 2 1/4 lbs. Dry cleanable.

Color: Bright Red and Black Plaid.

Men's sizes 30 to 50. Regular inseam.

Price, \$23.50 postpaid.



## Bean's Improved Sandwich Spreader

Professional quality of high grade stainless steel with mirror finish. Beautifully grained rosewood handle. Brass rivets. Blade is stiff enough to dig out thick spreads or for turning. Flexible enough for easy spreading and frosting. Sharp serrated edge cuts sandwiches, cheese, vegetables, etc. Overall length 7 1/2". Blade 3 1/2".

Price, \$1.25 postpaid

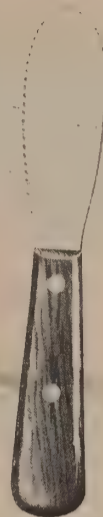

## Gerry Outdoor Equipment

The solidest reputation for innovative design in camping equipment belongs to Gerry Cunningham. (Now there's a statement that can be challenged. Do it.) Gerry packs, tents, parkas, sleeping bags, kiddie carriers, make up a well crafted well distributed line.

Gerry catalog Free

from:

Colorado Outdoor Sports Corporation  
P.O. Box 5544  
Denver, Colo. 80217

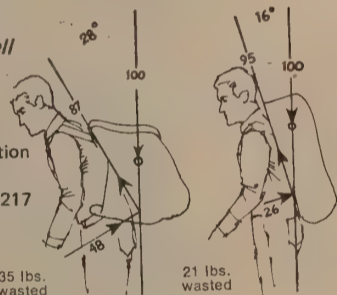

35 lbs. wasted

21 lbs. wasted

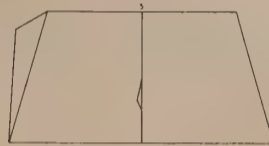

**Durability.** Crumpled-up newspaper will insulate. It will compress easily for packing. But once compressed, it will never regain its original thickness. Fine goose down, however, can be compressed tightly for months on end, yet it will always puff up to its original thickness within half an hour. Other materials tend to wear out, and lose thickness after each cycle of compression and release. Remember that thickness is warmth. So fluff up your bag as soon as the tent is up. Then fluff it up again before you crawl in. For more information on this subject, send for my free booklet, "How to Keep Warm."

**Dead air.** All modern insulating materials depend on dead air to keep you warm. Any material that intercepts air at 1/4" intervals or closer will insulate sufficiently. There is no miracle insulation. If it deadens the air, one material is as good as another.

**Thickness.** The amount of insulation depends on thickness. To get a good night's sleep at 0° F, you need about 2 1/2 inches of dead air all around your body. Thickness can vary, but for every thin spot you need a compensating thick spot. Our Gerry sleeper thicknesses are measured under the same pressure of .034 oz./sq. inch as used in the Fed. Std. 148(a) Filling Power Test for Down (see Fig. 1). They are not fluffed up and then scanned across the top of the tubes.

Most manufacturers brag about how much down they put into a bag. We brag about how little we use. Comfort ranges for each sleeper are for temperatures at which even a person who sleeps cold will be warm.

## Kaibab boots

*Kaibab boots are the real thing: traditional Indian desert moccasins. Made of deerskin and horsehide, they are light, attractive, and durable — just the right amount of improvement over bare feet. Unfortunately there are innumerable imitations of Kaibabs, all terrible. The giveaway is the seam between sole and top: if the sewing is visible on the outside the moccasins are frauds and will fall off your feet in a few weeks. Real Kaibabs will last six months of steady use, and when you finally come through the soles, you can send the tops to Tucson for new soles (\$12.00) and get another six months. (One warning. Kaibabs on wet slick sidewalk are sudden death.)*



49 Nomadics

Kaibab boots

\$18.75 mens

\$17.75 ladies

from:  
Kaibab Buckskin  
271 Nottt Stone  
Tucson,  
Arizona 85703

## Foam pads

Lighter than an air mattress • Warmer than an air mattress • Can't leak and let you down • Compact — carries in same stuff sack as your sleeping bag • Pillow pocket at head end • Removable waterproof cover facilitates airing and drying.

### 1 Shortie 20-Pound Camp

Number: N609 Weight: 1 lb. 2 ozs.  
Size: 36" long x 20" wide x 1 1/2" deep  
Shipping Weight: 2 lbs.

\$8.00

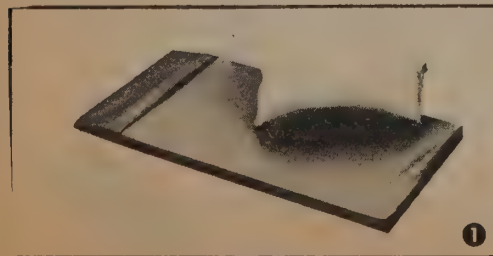

## Gerry Kiddie seat

2 Lightest of all frame carriers • Aluminum tubing • Tough canvas duck seat supports baby snugly high • Can be used as car seat with adapter strap.

Number: P952

Weight: 1 lb. 3 ozs. Shipping Weight: 2 lbs. 10 ozs.

\$11.00

	lb.	oz.
<b>his</b>		
Vagabond pack/frame	2	0
Wilderness sleeper	4	2
Shortie foam pad	1	2
Year-round tent/poles	5	0
1 1/2 qt. pot, lid,		
cup, spoon	..	10
3 lb. food	3	0
Poncho	..	14
<b>TOTAL WEIGHT</b>	<b>16</b>	<b>12</b>
<b>hers</b>		
Vagabond pack/frame	2	0
Wilderness sleeper	4	2
Shortie foam pad	1	2
1 1/2 qt. pot, lid,		
cup, spoon	..	10
Aid kit, cord, flashlight	..	9
Poncho	..	14
1 lb. food	1	0
<b>TOTAL WEIGHT</b>	<b>10</b>	<b>5</b>



After long hard wear

## Hot Springs

It seems incredible that there would be such a book. Here are map locations of all the known hot springs in the world, along with information on temperature, rate of flow, mineral content, and whether commercial or wild. You could travel the rest of your days from spring to spring, stopping at the Tatapani springs, on the west bank of the Sunkasi river ("3 springs forming small pool") 50 miles northwest of Mt. Everest, or the Hamman Ouled Sidi Abdeli ancient Roman baths, still flowing at 500 liters/minute, 81 F, 50 miles southwest of Oran, Algeria.

Published by the U.S. Geological Survey for a song, this directory fails to mention the plastic ice-water afterlife that awaits those who mess up wild hot springs.

Thermal Springs of the United States and Other Countries of the World—A Summary

Gerald Waring  
1965; 383 pp.

\$2.75 postpaid

from:  
Superintendent of Documents  
U.S. Government Printing Office  
Washington, D.C. 20402  
or  
WHOLE EARTH CATALOG

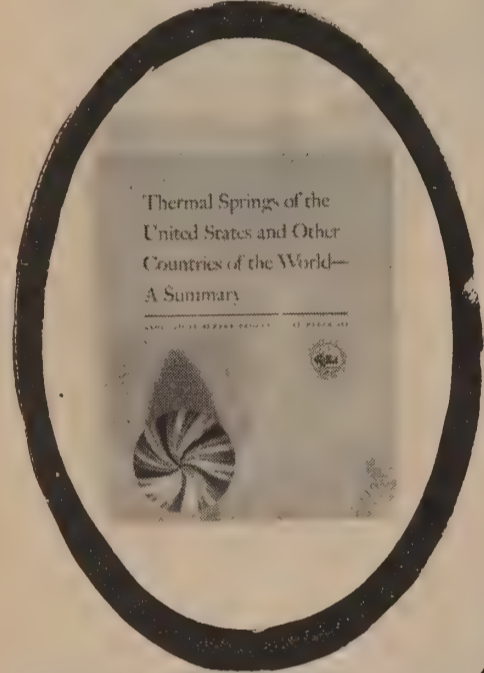

The Explorers Trademart Log



Most periodicals that have anything to do with exploring are about it, for people who don't do it: useless. This magazine is for explorers, by explorers. The span of subject matter includes backpacking, diving, sailing, flying, spelunking, prospecting, archeology, photography, treasure hunting, mountaineering, and conservation. The magazine is new and growing. Somewhat jolly in tone, it is full of specific gossip on tools, access, and current explorations.

[Suggested by Mack Taylor]

The Explorers Trademart Log

\$3.00 per year (monthly)

from:  
Explorers Trademart, Ltd.  
P.O. Box 1667  
Annapolis, Md. 21404

## Thermal springs and wells in Argentina—Continued

No. on fig. 15	Name or location	Temperature of water (°C)	Flow (liters per minute)	Total dissolved solids (ppm)	Principal chemical constituents	Associated rocks	Remarks and additional references
55	El Saladillo de los Colorados	34	Moderately large	4,560	Na, SO <sub>4</sub> , Cl	Precambrian(?) strata	1 main spring and several small flowing wells.
56	Surgente de Copal de Guayapa, 15 km southwest of Patquia.	22	Large	8,270	Na, SO <sub>4</sub> , Cl	do.	Flowing well. Water used for drinking by cattle.
57	Tatoritas, in La Rioja	26		400; 356	NaHCO <sub>3</sub>	Paleozoic strata	Water used for bathing.
58	Pismanta, 8 km west of Jachal.	40; 45			Na, SO <sub>4</sub> ; free H <sub>2</sub> S	Paleozoic limestone	2 main springs. Water contains much Fe <sub>2</sub> O <sub>3</sub> and Al <sub>2</sub> O <sub>3</sub> . Ref. 912.
58	Quebrada de Huaco (Hedionda)	21-25	100	2,300-2,868	Na, SO <sub>4</sub> ; much free H <sub>2</sub> S	Paleozoic limestone	Several springs. Deposits of sulfur. Water used for bathing. Ref. 905.
59	El Volcan	27.1		Moderately high	Na, SO <sub>4</sub> , Cl; free H <sub>2</sub> S	Tertiary(?) deposits	Water used locally.



Figure 15. California and Nevada showing locations of thermal springs. (Courtesy from ref. 115)

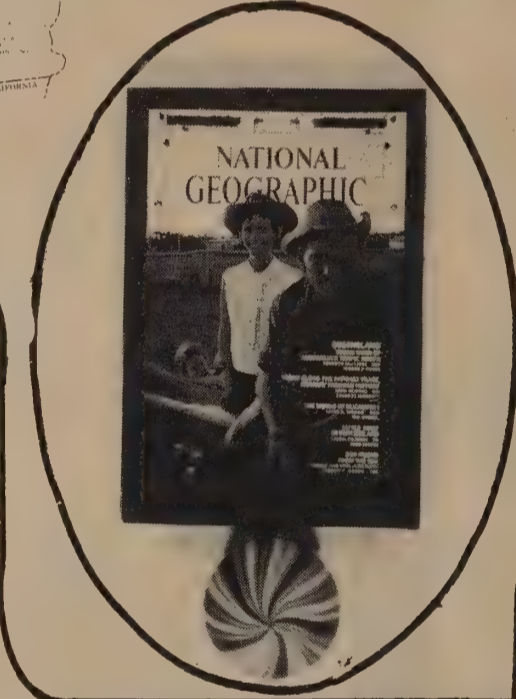
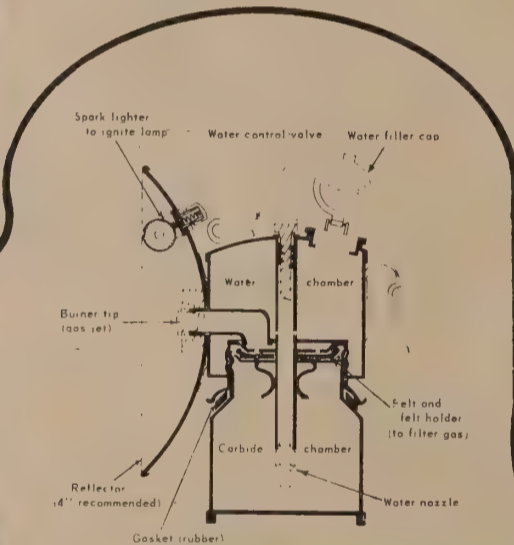
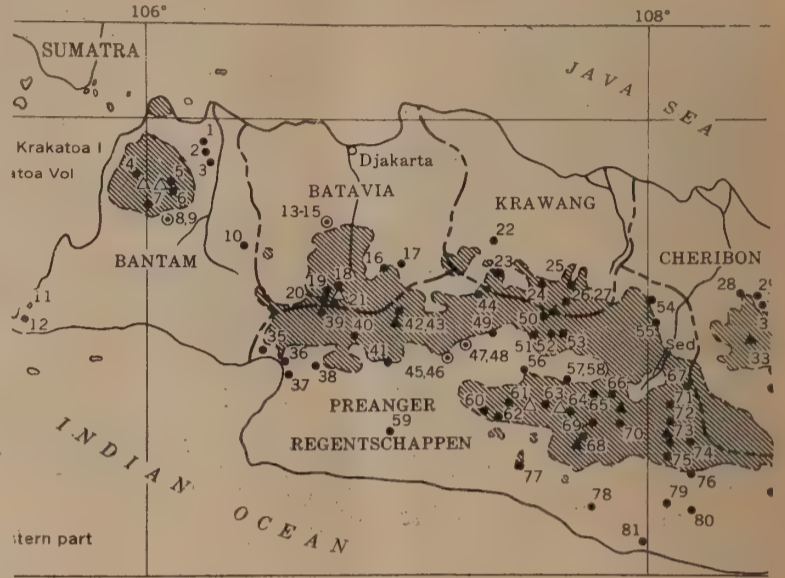

National Geographic

Everyone knows about National Geographic. This is just a reminder, or a tribute. Long live.

National Geographic

\$7.50 annual membership (\$9 outside U.S.)  
12 issues

from:  
The Secretary  
National Geographic Society  
Washington, D.C. 20036



## Ship Out on a Freighter

DAVE COLLINS

The Viet Nam war has opened sea-going jobs for Americans with or without experience. All you need is good health, American citizenship, and a yen for far away places. Far East in this instance.

The "angle", and it is an angle, derives from the emergency crewing situation experienced by the Military Sea Transportation Service. M.S.T.S. is the ocean transportation organization for the Department of Defense. Approximately two thirds of the employees are military personnel. All ship's personnel are civilian merchant seamen of the non-union variety. Herein lies part of the "angle". No union means no seniority preference, therefore no waiting. It also means no job security and no union contract, however that shouldn't bother the casual seaman, because the pay and everything else is the same.

The other part of the "angle" involves a thing called the Merchant Mariner's Document which is a

prerequisite to employment on any American ship. Only during emergency situations will the M.S.T.S. accept applications from persons without a document. Viet Nam is just such an emergency and while it lasts the M.S.T.S. is helping new seamen to obtain their cards.

The Merchant Mariner's Document is issued by the Coast Guard and stays with the holder beyond his employment with M.S.T.S. Once you have it you can use it from then on, regardless of who you work for. By the way, non-union jobs do exist, and the man, who is on the scene, and has his "ticket" (M.M. Document), can usually find work. You can join the union, of course, and go for the long term benefits, however unions are in business for the career seamen and are not in the business of accommodating sometime sailors.

The no-budget voyagers of this country, have in the past, usually had to "go foreign" in order to

work their way to the far corners and exotic parts of the world, but now, for a little while, it can also be a money making proposition. Moreover, the money comes in double helpings anywhere within one hundred miles of Viet Nam. The shipping turn around in Viet Nam has in the past been notoriously slow due to poor port facilities, so this has meant hundreds of dollars extra to even the lowliest seamen. The extra money is in the nature of a hazardous duty compensation. It must be admitted though that the war has not been at all dangerous for the merchant seamen.

Anyone with a few months to spare and the necessary nautical desire can address initial inquiries to: Commander, Military Sea Transportation Services, Naval Supply Center, Oakland, California 94625.

Bon voyage!

**Sierra Club**

Sierra Club is currently going global in its considerations, publishing gorgeous books on non-U.S. wildernesses, promoting Earth national park, etc.

We aren't listing their exhibit-format books simply because they aren't strictly tools. They do publish useful specific-locale books and if you're a member you get discounts on them. Other services to members include the monthly Sierra Club Bulletin and organized access to local and global wild places plus having a hand in obstructing dumb progress.

- \$14.00** first year individual membership; \$9.00 subsequently.
- \$18.50** first year for husband and wife; \$13.50 subsequently.
- \$8.50** first year for member 12 to 21; \$3.50 subsequently.

from:  
Sierra Club  
Mills Tower  
San Francisco 94104



**The Narrow Road to the Deep North**

Following the example of the ancient priest who is said to have travelled thousands of miles caring naught for his provisions and attaining the state of sheer ecstasy under the pure beams of the moon, I left my broken house on the River Sumida in the August of the first year of Jyōkyō among the wails of the autumn wind.

Determined to fall  
A weather-exposed skeleton  
I cannot help the sore wind  
Blowing through my heart.

After ten autumns  
In Edo, my mind  
Points back to it  
As my native place.

*The Narrow Road to the Deep North and Other Travel Sketches*  
Bashō  
1689; 1966; 167 pp.

**\$1.75** postpaid

from:  
Penguin Books, Inc.  
3300 Clipper Mill Road  
Baltimore, Md. 21211



**Trout Fishing in America**

There was nothing I could do. I couldn't change a flight of stairs into a creek. The boy walked back to where he came from. The same thing once happened to me. I remember mistaking an old woman for a trout stream in Vermont, and I had to beg her pardon.  
"Excuse me," I said. "I thought you were a trout stream."  
"I'm not," she said.

A little way from the shack was an outhouse with its door flung violently open. The inside of the outhouse was exposed like a human face and the outhouse seemed to say, "The old guy who built me crapped in here 9,745 times and he's dead now and I don't want anyone else to touch me. He was a good guy. He built me with loving care. Leave me alone. I'm a monument now to a good ass gone under. There's no mystery here. That's why the door's open. If you have to crap, go in the bushes like the deer."  
"Fuck you," I said to the outhouse. "All I want is a ride down the river."

*Trout Fishing in America*  
Richard Brautigan  
1967; 112 pp.

**\$1.95** postpaid

from:  
City Lights Books  
1562 Grant Avenue  
San Francisco, California 94133  
or  
WHOLE EARTH CATALOG

Sacred

To the Memory  
of

John Talbot

Who at the Age of Eighteen  
Had His Ass Shot Off  
In a Honky-Tonk

November 1, 1936

This Mayonnaise Jar  
With Wilted Flowers In It  
Was Left Here Six Months Ago

By His Sister  
Who Is In  
The Crazy Place Now

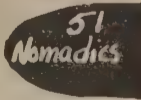

**Toward a Theory of Instruction**

We were going to carry Jerome Bruner's *Toward a Theory of Instruction* (\$3.95, Harvard University Press) here on account of his reputation, but on reading it I can't believe there isn't something better. If there is something better that you know about, would you tell us. If there isn't, would you mind reviewing this gentlemanly book? Fill this space, win a prize (\$10).

**The Black Box**

Officially, the name of this learning device is "The Inquiry Box." It was developed for Science Research Associates by Richard Suchman. It is a black wooden box (13 x 13 x 2"). On one side there are 3 small rectangular holes, the opposite side has one hole, and the remaining sides have 2 holes each. You don't know what's going on inside but something is. For example, there may be a string coming out of one hole and a rod sticking out of another hole. If you pull the string, the rod jumps. By pulling and pushing the things that stick out and by poking around inside with a stick you're supposed to figure out what arrangement of pulleys, pegs, springs and strings is inside.

There are an inexhaustible number of ways to arrange the insides with the components provided (see illustration). One kid can set up the "mystery arrangement" for another. You can set it up for them, they can set it up for you. And this certainly isn't limited to children. It's not at all a dull game for adults.

The Inquiry Box was designed for the teaching of theory building and theory testing to children. The teachers handbook gives you a very specific procedure to use the box by, but if you want to order (or make) just the box, you can learn a lot from it using it any way you please.

[Suggested by Dick Suchman, Reviewed by Jane Burton]

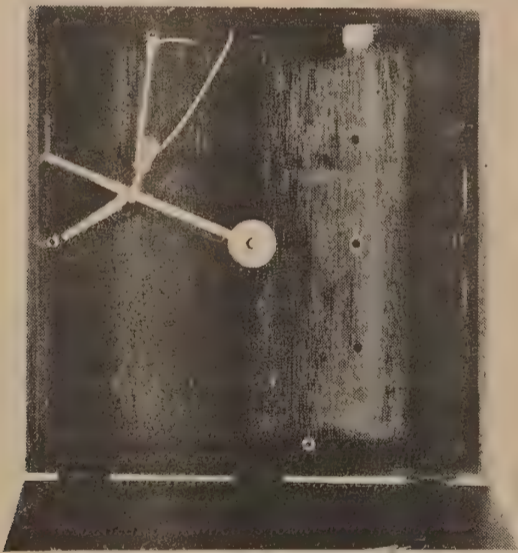

*Inquiry Box set*

**\$19.96** Shipping Weight 4 1/2 lb.

from:  
Science Research Associates, Inc.  
259 East Erie Street  
Chicago, Illinois 60611

**INQUIRY box theory sheet**

Science Research Associates, Inc., 259 East Erie Street, Chicago A Subsidiary of IBM **SRA**

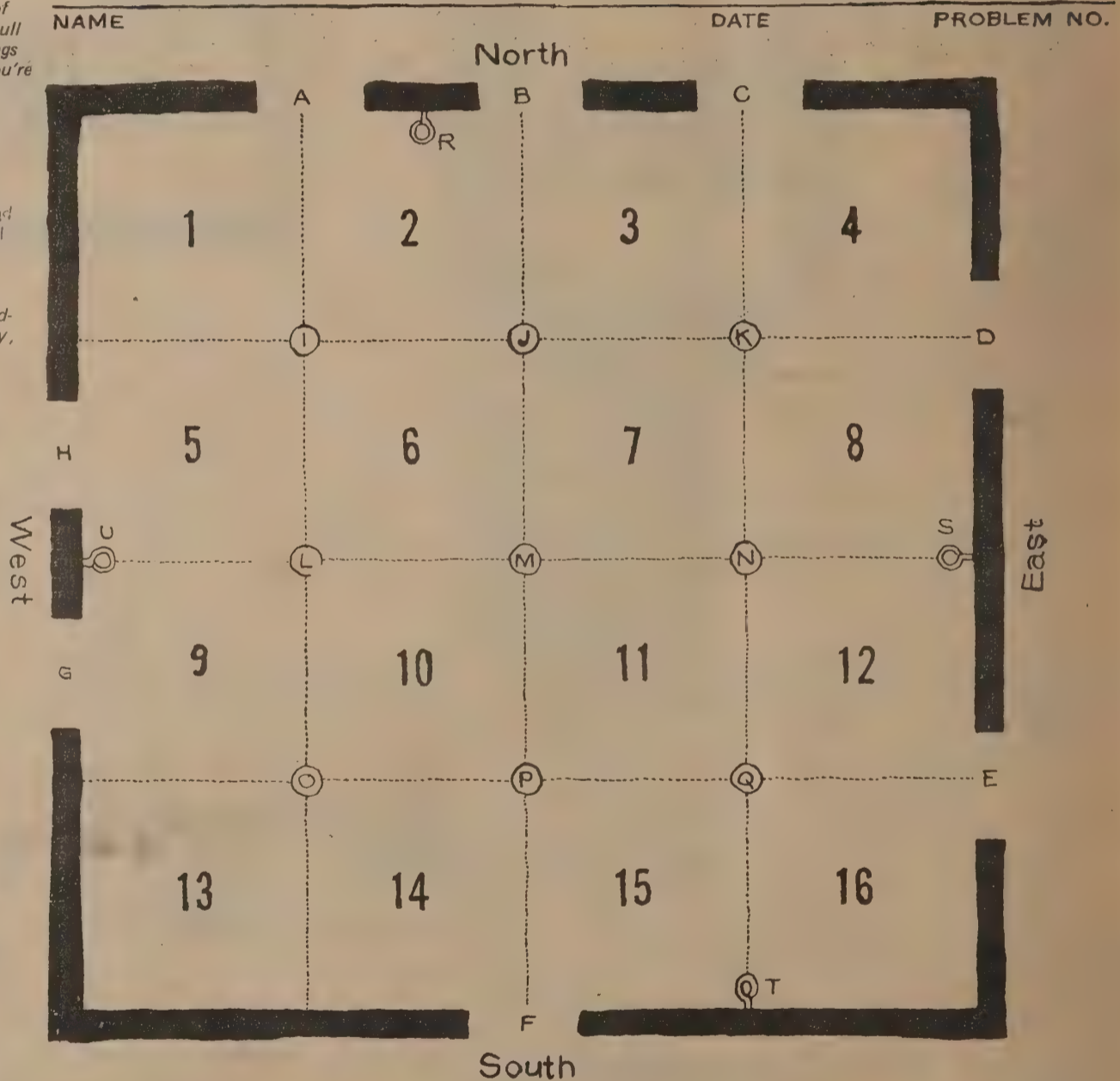

**POSSIBLE LINKAGE COMPONENTS**

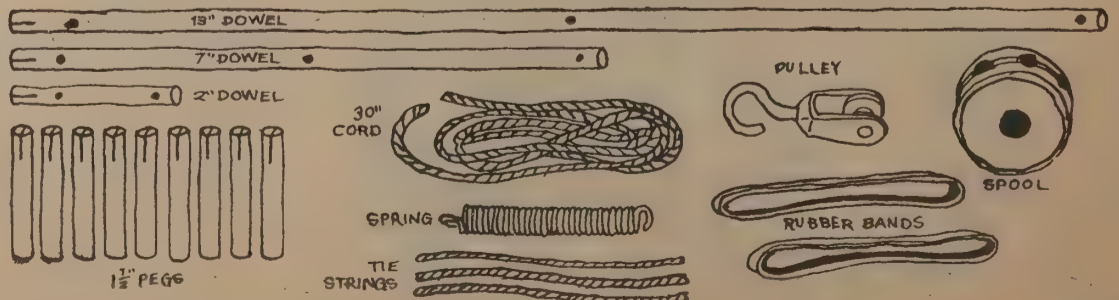

© 1967, Science Research Associates, Inc. All rights reserved. Printed in U.S.A.

Reorder No. 3-9383

**THIS Magazine is about Schools**

This is a double-good magazine about schools. Made in Toronto it's global in context and it's superbly written and edited. Everything else we've seen on education looks stale and sad next to it.

[Suggested by Jane Burton]

Until the cops attacked, the construction of the barricades was a bit like a celebration. There was an extraordinary atmosphere. If the police had retreated, there would have been a marvelous explosion of joy, everybody would have celebrated the liberation of the Quarter. We'd even thought about bringing along some orchestras. But the darker it got, the more the barricades got reinforced and multiplied, the more we realized that the attack of the cops, if it took place would provoke a massacre. That's why I agreed to go to the Rector's (Roche of the Sorbonne), not to discuss anything but to explain to him what was going to happen if the cops didn't withdraw.

Then to the accompaniment of loud boos and hisses, with only a scattering of applause, the vice-president of the Ontario Union of Students tore up his Bachelor of Arts diploma and marched out of the building.

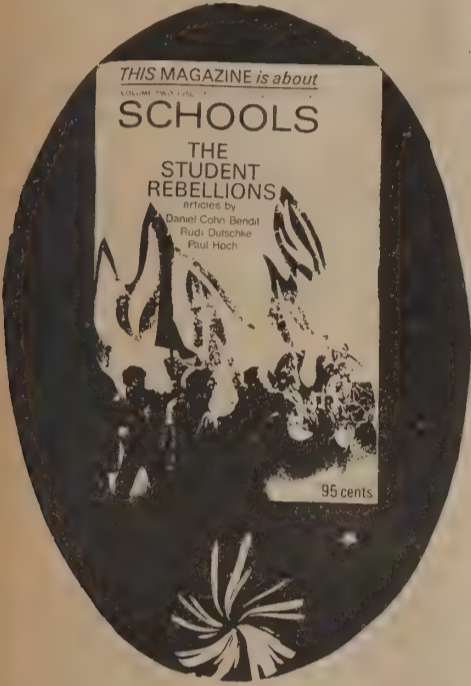

\$3.50 for one year (quarterly)

from:  
THIS Magazine is about Schools  
P.O.Box 876, Terminal A  
Toronto 1, Ontario, CANADA

Mr. Spelina's voice rises to a crescendo; he has not finished, but he has outdone himself, and he is outdoing the class. Delight has turned to confusion, and panic is spreading in the ranks. The French are holding fast, but the Spanish, with the exception of Mr. Ameller, are going under; Miss Fanaras has gone under. Mr. Cayo Junior is thinking about his girl-friend, and Mr. Rodriguez has decided to abandon English.

The lesson to us is: do not learn crafts from famous artists, but rather from competent technicians. Avoid like the plague teachers who talk a lot about self-fulfillment, self-realization, togetherness in creativity, or centering of your soul (that's for potters).

**THE HARD LIFE**

prepares children for the illogicalities and hardships of our present-day regimented existence. WAR BUSINESS TABOOS. points out the drawbacks of organized efficiency. FORCED TO READ SET BOOKS. shows how boredom can arise from enforced activity and lead to inactivity. DOZING IN CLASS. satisfies a child's need for simplified, structured surroundings. YOU KNOW WHERE YOU ARE.

permits nervous teachers to avoid personal relations with children. RETREAT TO THE STAFF ROOM.

**THE SOFT LIFE**

prepares children for life as active individuals. TRY IT MY WAY. points out the drawbacks of organized inefficiency. CAN'T FIND MY BOOK. shows how boredom may arise from freedom, also, and lead to activity. MUSTN'T WASTE OPPORTUNITIES. satisfies a child's need for diversity in exploratory play. THIS IS JUST A MODEL. permits teachers to get to know children well, on equal terms. NO TALKING DOWN.

**THE HARD-SOFT LIFE**

enjoys the advantages of the hard and soft. CONTRAST. shows how environment affects people and their work. GRAPH PAPER AEROPLANES. allows children to learn how to get the best of both hard and soft worlds. COMPUTERGRAPHIC PAINTING. demonstrates the need to work in an intermediate zone. DRAMA IN A FRAME. permits teachers to teach the way they like best. CHALKDUST FOR ME.

One of the students looked at President Harris Wofford and asked: "If we join your Socratic seminar, will you come and drop acid with us?"

A geography teacher from Whitby spoke of how he started off teaching knowing so little about geography that he used to call it geometry.

The hard-soft school might look something like this:

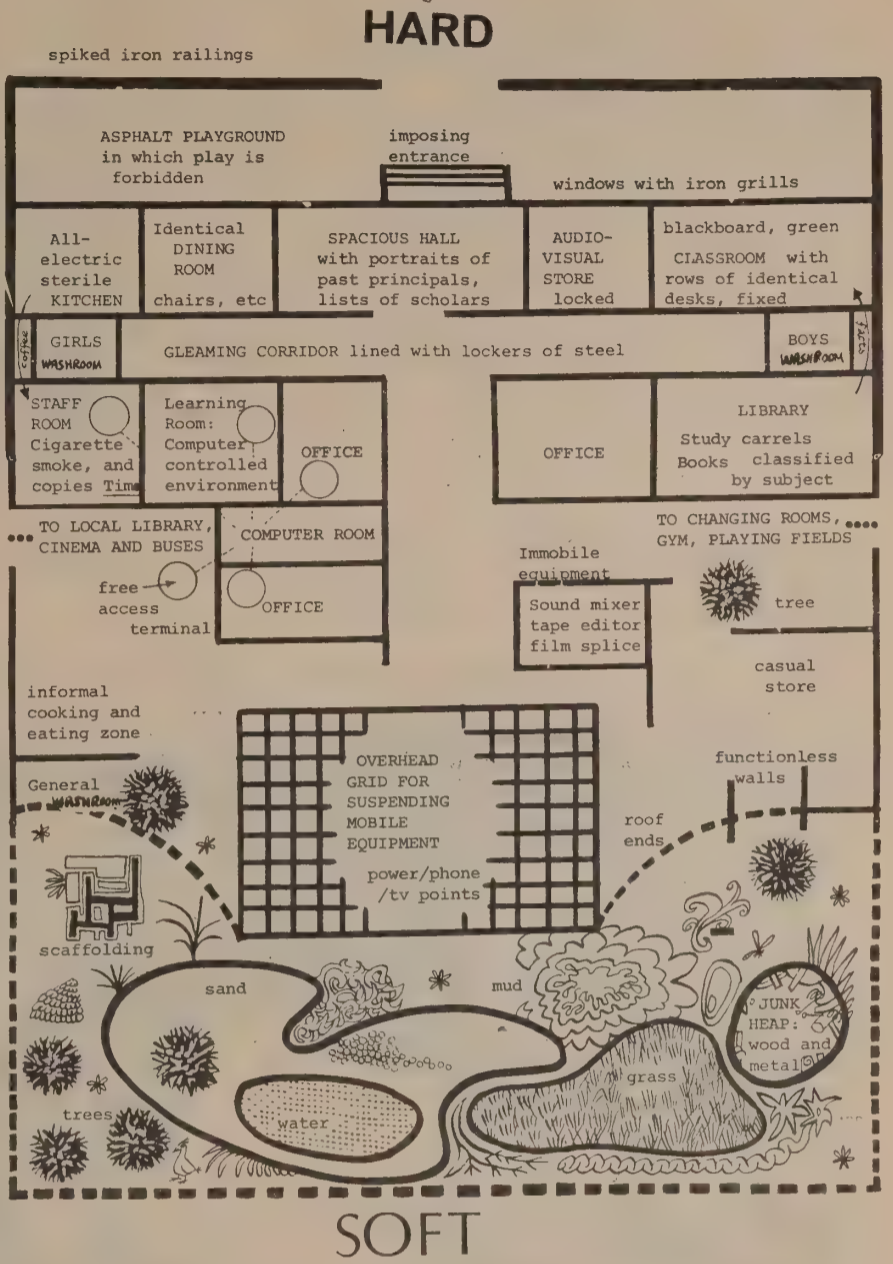

**Cuisenaire Rods**

The first rod is a small wooden cube with a 1 centimeter side. The second is twice as long with the same cross section. The third is three times as long as the first. Each length has its own color. With these rods, a child can learn arithmetical operations and mathematical relationships even though he recognizes no mathematical symbols. (Children are capable of grasping mathematical concepts before they have the mechanical ability to write. Therein lies one of the great advantages of Cuisenaire rods.) For example, if a child puts the first (white) and the second (red) rods end to end he can see that together they are equal in length to the third (green) rod. Once he realizes that a white and a red always equal a green, he has learned something quite general about addition and equality. If, later, the numeral '1' is associated with the first rod, '2' with the second rod and '3' with the third, he will be in a position to grasp at once that  $1 + 2 = 3$ . But the rods have no absolute numerical value so that if the value '1' were assigned to the third rod rather than the first, the truth  $1/3 + 2/3 = 1$  would also be forthcoming as 'proved' by the general rule that the child discovered with the rods.

What is happening here is that algebra (the general case) is being learned before arithmetic (specific cases), as logically, it should be.

discovering mathematical relationships with

## RODS

- Fig. 1: A staircase-like arrangement of rods.
- Fig. 2: A grid-like structure of rods.
- Fig. 3: A large grid of rods.
- Fig. 4: A diagram showing a rod divided into four equal parts.
- Fig. 5: A diagram showing a rod divided into three equal parts.

This is undoubtedly one of the best pieces of teaching equipment ever invented. But it is important that you don't show children the truths that the rods demonstrate. They must be allowed to discover these themselves or it won't work. Mathematics with Numbers in Color, books A,B,C,D are a worthwhile purchase if you don't feel sure of how to use the rods. Also, For the Teaching of Elementary Mathematics will give an idea of what's going on when a child learns (as opposed to memorizing) math.

chase if you don't feel sure of how to use the rods. Also, For the Teaching of Elementary Mathematics will give an idea of what's going on when a child learns (as opposed to memorizing) math.

Catalog Free.  
Basic classroom kit (for 25 children), includes above books. \$57.50  
Cuisenaire Home Mathematics Kit \$12.50

[Suggested by Virginia Baker  
Reviewed by Jane Burton]



ita shærz wifh cuisenaire rods a hie repuetæshon for chænjig the formerly grim tō the nou-delietfwil. Uezuealy kids lernig tō reed and riet or disceridzd nœ end bie the illodzick ov normal inglish spelling. With the ita affabet, it's mor lodzickl and consistint. Riten lærgwidz becumz a tōl insted ov a drag; the kids commens reedig and rietig on thær oen tiem, læter on thær mæk the shift tō normal ideetick spelling without pertickuelar stræn. Wun ov thæs jeneræshons mæ not bother tō shift.

ita has other applicæshons ie beleev. for wun, yō can heer riten lærgwidz better with it. An ita translæshon ov FINNEGAN'S WAKE wōd bēe a reeal servis.

[A BETTER INFORMED REVIEW OF THIS SUBJECT IS NEEDED]

There's plenty of workbooks, manuals, library materials, etc. available from: Initial Teaching Alphabet Publications, Inc. 20 East 46th Street New York, N.Y. 10017

The best how-to-do-it introductory text I've seen is "The ITA Handbook for Writing and Spelling" item No. 9-013. If you can get it by itself, it costs \$1.50.

Promotional literature is free.

devised in ingland bie sir jæms pitman and introdused in 1963 in the uenieted stæts, the inishial tæchig alfabet (i t a) is used as a transishonal tæchig tōl tō help pœpl lern tō reed. it has 44 symbols, eēh representig wun sound, which tæk cær ov the fœnetic irreguelæritis ov the tradishonal alfabet. after haviḡ lerned tō reed with i t a, the beginner transfers with ees tō the tradishonal alfabet.

The second yeer ov eksperimentæshon with i t a in this cuntry has shœn remarkabl effectivness, not œnly in meny first græds, but aulsœ in remeedial reedig, kindergarten reedig rediness, and adult illiterasy classes.

From back cover of *Winni-the-paw*

\$2.95 postpaid

published by E. P Dutton  
201 Park Ave South  
New York, N.Y. 10003

thær wox nœ wind tō blæ him neerer tō the tree sœ thær hee stæd. hee cōd see the huny, hee cōd smell the huny, but hee cōdn't kwiet reech the huny.

after a littl whiel hee cauld down tō yō. "Cristofer robin!" hee sed in a loud whisper.

"hallo!"  
"ie thigk the bees suspect sumthing!"  
"whot sort ov thig?"

"ie dœn't nœ. but sumthing tells mee that thær suspifshius!"

"perhaps thær thigk that yō'r after thær huny?"

"it mæ bee that. yō never can tell with bees."

thær wox anuther littl sielens, and then he cauld down tō yō agæn.

"Cristofer robin!"  
"yes?"



LIFE Science Library



LIFE Science Library from: Time-Life Books, Inc. Retail Sales Dept. 540 N. Michigan Ave. Chicago, Illinois 60611

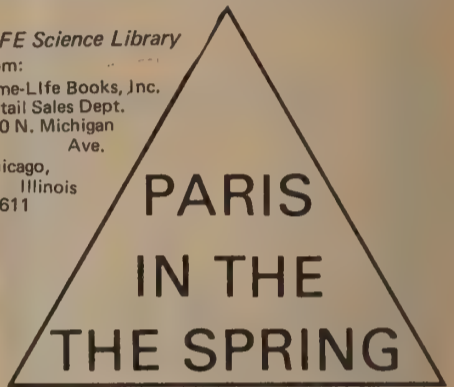

WHAT'S WRONG WITH THIS PHRASE? At first glance, seemingly nothing. But with closer reading the repetition of the word THE becomes obvious. Because we generally read rapidly in word patterns rather than slowly a word at a time, it is easy for the eye to skip over the extra THE and register the familiar phrase "correctly."

Learn by leaving books around. These books anyway. They get picked up randomly, glanced into, and hours later you're still there on the john or wherever helplessly engrossed in diagrams explaining the design of musical instruments.

Rumor was, a few years ago during one of the Time-Life shuffles, that a lot of the best people there had gone into Time-Life books. I believe it. This series is well edited, illustrated, and authored. *Man and Space*, for example, is by Arthur C. Clarke; *Water*, by Luna Leopold and Kenneth Davis.

Most popular science books are badly behind the times. This series puts special emphasis on recent developments.

The books are only available by mail from Time-Life Inc.

A book comes every month or so, with a bill for \$3.73, and you either send the book back or pay up. Some are better than others, but we haven't sent one back yet.

While the outermost reaches of Jupiter's atmosphere are extremely cold, the internal temperature is probably quite high, due to a "greenhouse effect," in which the atmosphere acts as an insulator to hold in heat from the sun. Water might exist there, permitting the formation of the "organic soup" which sparked the first earthly seeds of life. It is now believed, in fact, that Jupiter's hydrogen-ammonia-methane type of atmosphere is what existed on the primitive earth in the days when life made its first appearance.

Although Jupiter's cloud cover is constant, most of the cloud markings we see there are quite transient, and disappear after a few days or weeks. However, there is one puzzling formation which has remained visible, on and off, for at least 130 years. This is the famous Great Red Spot, an oval shaped mass lying parallel to the planet's equator and not far from it, in the Southern Hemisphere. The Great Red Spot is considerably larger than our entire earth, yet it drifts around Jupiter like a gigantic raft; it has made several revolutions of the planet during the century that it has been under intense observation. The most popular theory holds that the Great Red Spot is a huge meteorological disturbance.

Kaiser Aluminum News

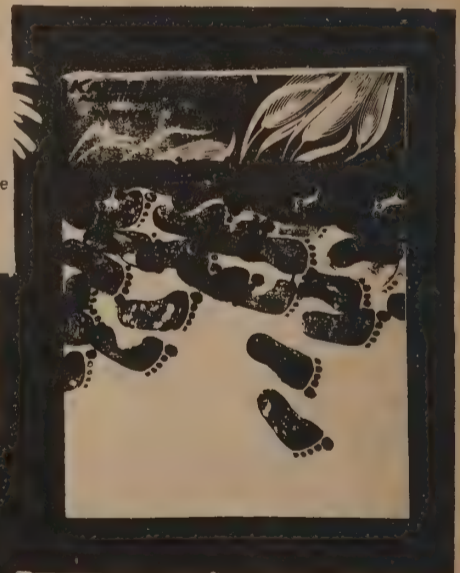

Don Fabun is doing very well at his job of making Kaiser appear comprehensive and futuristic. The Kaiser Aluminum News that he edits comes out several times a year, each issue devoted to one large topic, such as communication, transportation, food crisis, etc. They are excellent compendiums of current thought, vividly illustrated and laid out. Best of all, they're free if you write Kaiser for single copies.

Inquire for their list at: Public Affairs Department Kaiser Aluminum and Chemical Corporation Kaiser Center 866 Oakland, California 94604



PIECES OF A PICTURE

The object of this perception test is to fill in the missing pieces so that a familiar picture appears. If the test remains puzzling at normal reading distance, try it again from three or four feet before looking at the answer below.

A horse and rider.

Light and Vision

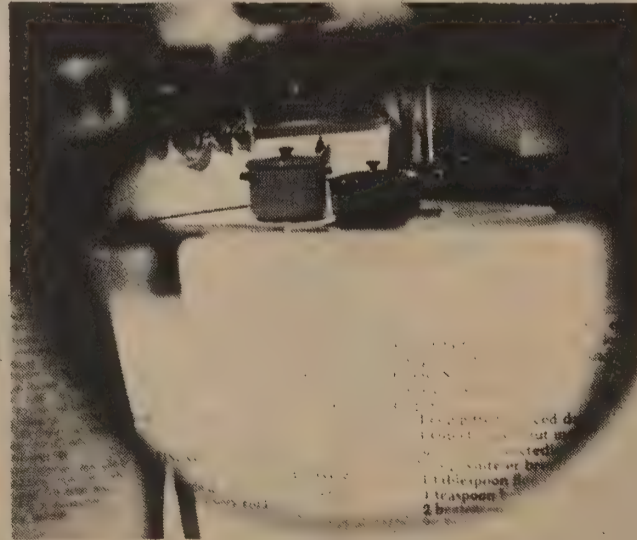

TWO LENSES IN ONE

Bifocals—introduced to America in the 18th Century by Benjamin Franklin—help older people with rigid lens structure to focus at both near and far distances. The upper half of the spectacle lens gives slight correction for distant viewing. The lower half is for close-up work; it provides the increased refraction needed to compensate for the increasing rigidity—and the inability to focus—of the aging lens.

Light and Vision



The Road to Kwashiorkor

It is the custom in many of the diet-deficient areas that children are not weaned until the second or third year of life. They thus may receive enough calories, but insufficient protein. The result is a disease called "kwashiorkor" which may disable the child for life and frequently is fatal. The child shown above in a "before" and "after" sequence demonstrates the dramatic "improvement" that takes place when sufficient protein is fed to a child suffering from kwashiorkor.



This book grew out of a smaller volume called *Suggestions for Science Teachers in Devastated Areas* whose production was sponsored by UNESCO right after World War II. It was meant for use in schools whose buildings and labs had been destroyed and soon found its way into the hands of people who had never had these things to begin with. Thus it solves the problem of schools, communities—people—who want to do 'live' science without money or equipment. There isn't any experiment in it which would be too costly for any of us to do. The book tells you how to put together the equipment you need: real clever ways of making glass cutters, balances, burners, telescopes, microscopes, etc. A lot of what you need to do the experiments is just stuff you'd have around the house. The rest can be gotten [very low cost stuff] at the drugstore, hardware, junk yard, etc.

Also the book is unusually well written. There's no bullshit in it and it doesn't talk down to the reader. Just very straightforward instructions with illustrations that are highly readable. In most cases you aren't told the outcome of the experiment, an aspect which makes you much more interested in doing it. [Jane Burton]

700 Science Experiments for Everyone  
1958; 250 pp

\$4.00 postpaid

from:  
Doubleday & Company, Inc.  
501 Franklin Avenue  
Garden City, L.I., N.Y. 11531  
or  
WHOLE EARTH CATALOG  
or  
Edmund Scientific

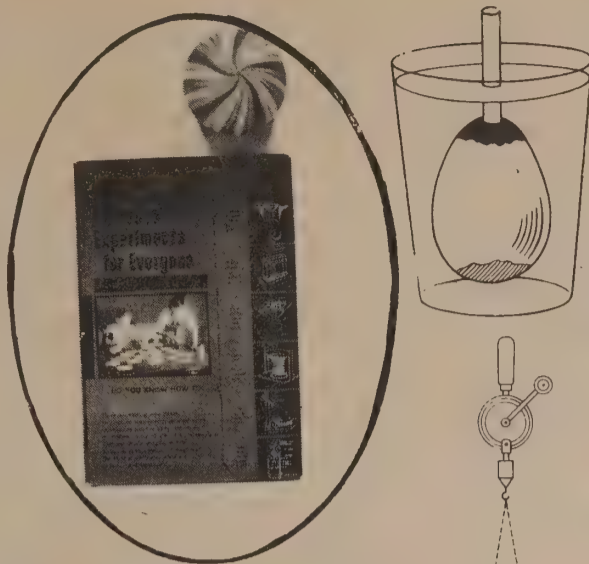

**An egg osmometer**

Place some dilute hydrochloric acid or strong vinegar in a shallow dish, such as a saucer, to a depth of about one centimetre. Hold the large end of an egg in the acid until the shell has been eaten away on the end leaving the thin membrane exposed. Rinse the acid from the egg. With a sharp instrument work a small hole through the shell at the other end. Insert a soda straw or a length of glass tubing through the hole into the interior of the egg. Seal the opening around the tube with household cement or sealing wax. This must be absolutely tight. Place the osmometer in a glass of water and let it stand for a few hours.

**Making smoke prints of leaves**

Smoke prints of leaves may be easily made by following the four steps shown in the diagrams.

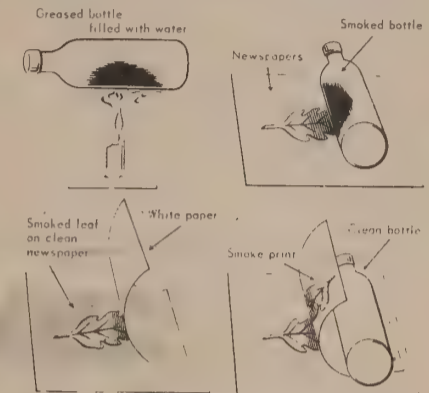

Cover the side of a smooth, round bottle with a thin layer of grease or vaseline. Fill the bottle with cold water and cork it tightly. Hold the bottle over a candle flame until it is covered evenly with soot. Place a leaf, vein side up, on a layer of newspaper and roll the sooty bottle over the leaf. Remove the leaf and lay it vein side up on clean newspaper. Cover the leaf with a sheet of white paper. Next, roll over the white paper and leaf with a clean round bottle or other roller.

**A model illustrating how an eclipse appears**

The sun is represented by an opal electric bulb shining through a circular hole 5 cm in diameter in a piece of blackened cardboard. The corona is drawn in red crayon around this hole. The moon is a wooden ball 2.5 cm diameter mounted on a knitting needle. The observer views the eclipse through any of several large pin holes in a screen at the front of the apparatus. The corona only becomes visible at the position of total eclipse. The moon's position is adjusted by a stout wire bicycle spoke attached to the front of the apparatus.

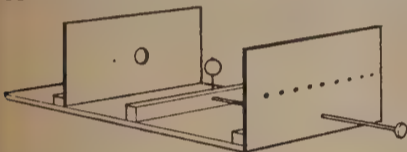

**Another way to show that water pressure increases with depth**

Find a tall tin can. Punch holes up the side of the can about 3 cm apart. Put a strip of adhesive or plastic tape over the row of holes and fill the can with water above the top hole. Hold the can over a sink and strip the tape from the holes beginning at the bottom. Observe the streams and note the distances travelled outwards from the can.

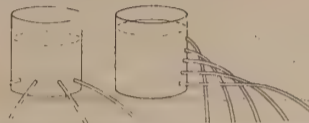

**Water pressure is the same in all directions**

Punch holes around the base of a tall tin can with a nail. Cover the holes as above with a strip of tape. Fill the can with water and strip off the tape while holding it over a sink. Observe and compare the distance the streams shoot out from the holes all around the can.

**A simple rotation machine**

Secure a breast-drill or hand-drill such as the one shown in the diagram. Clamp a small screw eye or cup hook in the chuck of the drill. Attach a 30 cm length of light string near the point end of a spike. Make a loop in the other end of the string and attach it to the screw eye in the chuck of the drill.

Now rotate the drill steadily by crank. Observe how the centrifugal force affects the suspended spike.

Edmund Scientific

Edmund is the best source we know of for low-cost scientific gadgetry (including math and optics gear). Many of the items we found independently, such as Dr. Nim, 700 Science Experiments, Geo-D-Stix, Spilhaus Space Clock, etc., turned up in the Edmund Catalog, so we were obliged to recognize that in this area we've been preceded. They list 4,000 items, they ship, and their catalog is free.

Order from:  
Edmund Scientific Company  
100 Edscorp Building  
Barrington, N.J. 08007

**"HOMEBUILT TELESCOPES"**  
Shows you how to make a reflecting telescope mirror with surface accuracy to a millionth of an inch. It will save you as much as \$40.00 on the mirror alone, based on the cost of a finished 6" mirror. 1/4-wave quality. Detailed instructions on: Grinding the curve, forming the curve, finding the focal length, testing the curve, smoothing the curve, polishing, correcting techniques, parabolizing, etc. Also mechanical construction of the telescope itself. 36 pages (8 1/2" x 11").  
No. 9066 75c Postpaid

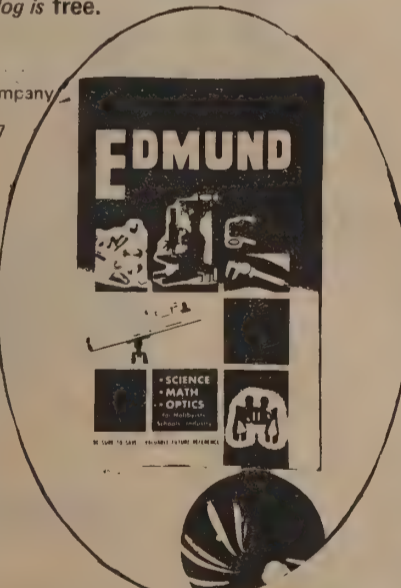

**HAVE FUN WITH SCIENCE OF SOAP BUBBLES**

Create endless complex shapes, study and enjoy their fascinating behavior. Learn about liquid skins, pressures, jets, electrical conduction and the membrane theory of stress distribution. Chemist designed kit includes special, longer-lasting, lower-cost bubble formulation (makes several gallons). Sticks with poly connectors and wire bending jig to make bubble frames, plus 190-pg. book on subject by C. V. Boys. Complete instructions.  
No. 70,742 \$6.00 Ppd.  
Formulation only. No. 40,782 \$3.00 Ppd.

**FASCINATING... WORLD'S SMALLEST LAMPS**

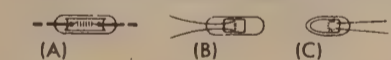

Their unique physical size (.016" to .124" in diam.) and electrical characteristics make them ideal for applications where power and space requirements are set at the absolute minimum. Slightly out of military specifications for aerospace use, but fully suitable for use by the experimenter or hobbyist. All have pigtail leads. May be used for transistor indicators, optical point sources, illuminated jewelry, medical and industrial light probes, modulated light sources, pointer and meter scale illuminators, read out devices, model railroad illumination.

Lamp	(A)	(B)	(C)
Volts	1.5	1.5	5
Current, milliamperes	15	30	55-120
Diameter, inches	.016	.030	.124
Length, inches	.065	.080	.250
Light Output, millilumens	60	160	300-1800
Life Expectancy, Hours	1,000	1,000	4,000-16,000
Lead Diam., mils	3	4	7-10
Lead Length, in. (Min.)	3/8	3/8	1/2-1/4
Lead Material	platinum	platinum	copper
Stock No.	40,689	40,690	40,691
Price, Postpaid	\$4.25	\$4.25	\$2.10

**"THINK STICKS" THE MODERN KITS FOR INDUSTRIAL, EDUCATIONAL, FUN USES... VISUALIZE IN 3 DIMENSIONS**

Here is the ideal visualizing and demonstration tool for teachers; learning aid for students in mathematics, physics, chemistry, design, and architecture. Excellent for Science Fair projects. Hobbyists and artists find them fascinating and extremely useful.

In mathematics, Think-Sticks Kits are used to construct geometric figures ranging from triangles and cubes to such multiple sided figures as icosahedrons and dodecahedrons. In design classes, models are made to determine functional and esthetic efficiency. Architectural and engineering instructors mock up girders, trusses, towers, frameworks; and demonstrate the nature and effect of stress. The State University of Washington, for example, is now using these in its Architectural and Engineering Laboratories.

Professional uses aside, Think-Sticks open new horizons of fun, knowledge and experimentation for any youngster. Ease of use and durability make Think-Sticks much superior to old-fashioned wood or metal kits. 1/8" diameter plastic or birch sticks fit smoothly into 1" polyethylene joints having 1/8" sleeves—form rigid structures. (Connectors can now be bought separately. T-connector supplied only with KIT No. 70,211.) Complete instructions included. Money-back guarantee.

**KIT No. 70,209.** Ideal introductory set. 220 pieces... 5, 6, & 8-sleeve connectors; 2, 3, 4, 5, 6, and 8" colored Think-Sticks. For all geometric structures and many artistic designs.  
\$3.00 Postpaid

**KIT No. 70,210.** Ideal for assembly of models, transmission towers, and for anyone with advanced interests. 370 pieces including 5, 6, 8-sleeve connectors; 2, 3, 4, 5, 6, 8, 10 and 12" colored Think-Sticks. Complete kit.  
\$5.00 Postpaid

**KIT No. 70,211.** Adequately fills the needs of schools, architects, designers, any group at the professional level. 452 pieces include 5, 6, and 8-sleeve; and T-connectors. (T-connector allows Think-Stick to pass clear through); 2, 3, 4, 5, 6, 8, 10 and 12" colored Think-Sticks; and long length of unpainted Think-Sticks which can be cut to any size required for your own designs.  
\$7.00 Postpaid

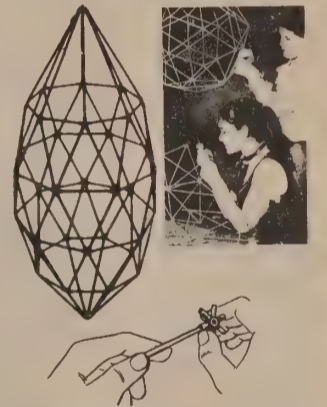

**SEPARATE CONNECTORS, UNPAINTED STICKS**

No.	Type	Pkg. of	Price
P-60,108	(A) 5-sleeve	50	\$2.45 Ppd.
P-60,109	(B) 6-sleeve	50	2.45 Ppd.
P-60,110	(C) 8-sleeve	50	2.45 Ppd.
P-60,111	(D) T-conn.	50	2.45 Ppd.
P-60,112	24" Sticks	100	2.00 Ppd.

**THE WORLD'S MOST INFORMATIVE CLOCK**

CREATED BY DR. ATHELSTAN SPILHAUS  
SPILHAUS SPACE CLOCK

Dr. Spilhaus, one of America's leading scientists, took 5 years to develop this space-age astronomical clock. It is the modern counterpart to the old fashioned orrery. Large top dial has 5 transparent overlay discs. Four, rotating independently, combine with the fixed disc to capture the depth of the night sky and automatically show you 19 up-to-the-minute pieces of information related to time, the moon, sun, stars and tides.

- Read Top 8 1/2" Dial for . . .
1. The horizon and the visible heavens
  2. The sun's position in the sky
  3. Moon's position
  4. Position of the stars
  5. Relative positions of sun, moon & stars
  6. Day, month, year. A perpetual calendar
  7. Meridian solar-time of sun, moon & stars
  8. Sidereal or star time (used with tables)
  9. Current phase of the moon
  10. Time of daily sunrise and sunset
  11. Mean time of moonrise and moonset
  12. Mean time of star-rise and star-set
  13. Current time of high or low tide
  14. Current stage of the tide
  15. Mean solar time
- Lower Left 4" Dial shows . . .
16. Ordinary or zone time
- Lower Right 4" Dial shows . . .
17. 24-hour time
  18. Universal or Greenwich Mean Time
  19. Time in major cities of USA and world (L.M.T.)

**HOME SCHOOL OFFICE STORE LIBRARY CLUB ROOM**  
Illuminated Dials



A SPACE AGE INFORMATION CENTER—An up-to-the-minute encyclopedia of the skies for the home . . . for amateur astronomers, space enthusiasts, fishermen, boat and aircraft owners, shore residents, teachers, scientists.

**No. 1202 \$250.00** Trans. Chg. Coll. Learning  
Also available nationally through selected dealers.

**Harness the Incredible Heat of the Sun for Experimenting... MAKE A 2,000° SOLAR FURNACE**

An ideal project for your next Science Fair. Think of it, your friends will be amazed that you can harness the incredible heat of the sun for experimenting or for such projects as the following.  
• With the solar furnace, you can use the sun for soldering and brazing.  
• Temper small flat springs • Fire enamel on jewelry  
• Make a barbecue grill for cooking hot dogs, hamburgers.  
Focus the noonday Sun on a newspaper and it will burst into flame in half a minute. For only a few dollars you can build a simple, easy-to-make Solar Furnace from this Edmund Fresnel Lens and some scrap parts. It will develop temperatures of 2000° within the area of the focus spot. See the complete description of Fresnel lenses on page 93.  
This particular Fresnel lens is approx. 11 1/4" square. It is 1/4" thick and has an effective speed of about f/1.5. Only the lens is furnished, not the wood and other parts for the furnace. Included is our 14-page instruction booklet on solar energy and solar furnaces. Lens and booklet described above.  
No. 70,533 \$6.00 Postpaid  
Solar Energy and Solar Furnaces instruction and idea booklet only. No. 9053 40c Ppd.

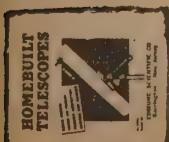
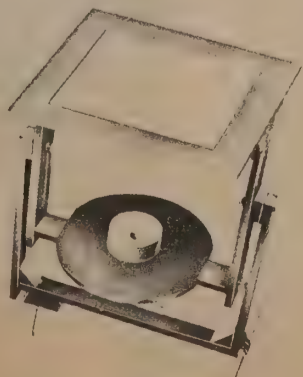

## WFF 'N PROOF

The WFF 'N PROOF games came out of the ALL project (Accelerated Learning of Logic) at Yale Law School. This project was established in 1960 to develop materials to teach mathematical logic to elementary school students. The authors' first principle in designing the games was that they be fun to play.

The primary aim of WIFF 'N PROOF is to encourage a favorable attitude toward symbol manipulation activities in general and, incidentally, to teach something about mathematical logic and provide practice in abstract thinking.

[From the introduction to the WIFF 'N PROOF manual.]

WFF 'N PROOF is a series of 21 games. The first ones can be played by children (starting around age eight), the last ones are difficult enough to interest logicians. The first game can be bought separately under the name of just 'WFF'. It is the best game and children always like to play it. In it you learn what a WFF (well formed formula) is, and there is no nicer way of doing that. The rest of the games teach you about constructing logical proofs. They are more tedious and a good teacher can find ways of doing this which are more fun. There's no harm in getting the whole set, however, and using it as long as it works.

[Reviewed by Jane Burton]

WFF \$1.50 postpaid

WFF 'N PROOF \$6.50 postpaid

from:  
WFF 'N PROOF  
P.O. Box 71  
New Haven, Conn 06501  
or most book stores

Also worth investigating from WFF 'N PROOF are:  
Tac Tickle \$1.25 postpaid (We play it in bed)

Th: REAL Numbers Game \$1.25 postpaid

On - Sets: The Game of Set Theory \$4.50 postpaid

Equations \$3.50 postpaid

The Propaganda Game \$5.50 postpaid

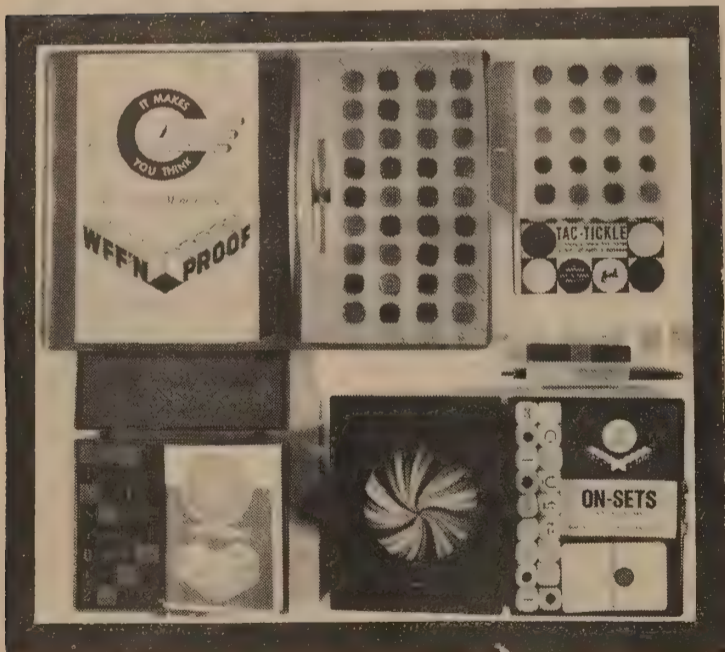

## Dr. Nim

Arrange 15 matches in 3 rows with 3 in the first row, 5 in the second row, and 7 in the third row.

```

  | | | | |
  | | | |
  | | | | |
  
```

This is a game for two players. You win by forcing your opponent to pick up the last match. When it's your turn, you play by taking as many matches as you like from any row (you may take the whole row if you like) but from one row only. This is the game of NIM and is actually a logical puzzle, for the first player can always win once he knows the winning strategy. The puzzle is to figure out that strategy.

Dr. Nim is a simple but amazingly clever computer which is programmed to play a perfect game of NIM with you. But Dr. Nim goes second so it is possible to beat him. He will win every time, however, until you figure out the winning strategy.

Dr. Nim is played with marbles instead of matches and the marbles are taken off the board by being released by a mechanical trigger. When it is Dr. Nim's turn to play you press the trigger once for him and then, if it's in his best interest to release more marbles, he will do so by running the marble over the trigger.

There's a good manual that comes with the game which tells you a little about computers and computer logic. It's the best way I know to give kids (or grown-ups) an idea of how computers work.

[Suggested and reviewed by Jane Burton]

from the Manual:

Man has a stream of consciousness, an identity, he thinks about himself, he philosophizes one minute and proceeds to solve a problem the next. He has a huge recognition memory that functions effortlessly. Having met a person only once, for example and seen him from only one angle, he recognizes him again in a different position. Of course, he has difficulty recalling his name, but his memory seems to be designed primarily for recognition, not recall. If he goes into a movie in the middle, he recognizes immediately the point at which he came in because he recognizes that he has seen and heard this part of the film before. Yet he cannot recall what the actors are going to say next. When they say the next sentences, he recognizes immediately that he has seen and heard them before, however.

from:  
Edmund Scientific Co.  
100 Edscorp Building  
Barrington, New Jersey 08007

Dr. Nim

\$3.50 postpaid

or some toy stores



## We Built Our Own Computers

Time was, kids built their own radios. Now it's rockets and computers, and so much the better. Once you've built one computer you have a far more sophisticated relationship with all computers. This British text, prepared by five school boys who indeed built their own computers, is an excellent introduction to hands-in technique

[Suggested by Jane Burton]

We Built Our Own Computers

ed. A. B. Bolt

\$1.95 postpaid

from:  
Cambridge University Press  
32 East 57th St.  
New York, N. W. 10022



## Electric Logical Computer Exeter

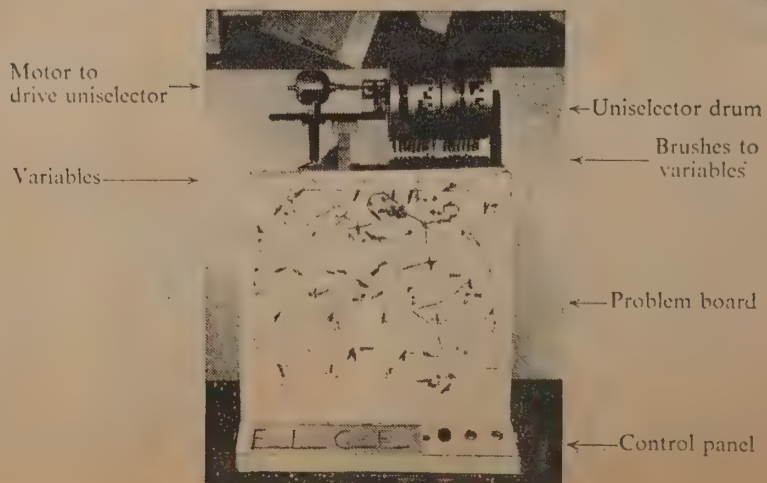

**American Boys Handy Book**

Dan Beard's *American Boys Handy Book* was first published in 1882. Out of print for a long time, Tuttle has finally reprinted it. This is barefoot-boy-with-cheek-of-tan stuff, detailed lore on how a boy may make his own world. Extraordinary book, highly recommended for funky schools or communities, especially if woods are handy.

[Suggested by Arthur Brand]

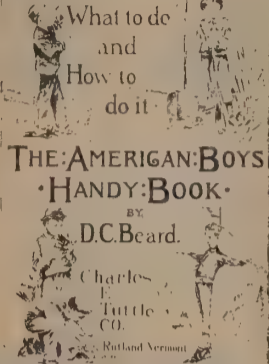

The Paper Pitfall.

Over the top of an earthenware jar fasten a piece of writing

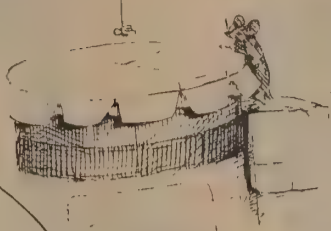

**The American Boys Handy Book**

D. C. Beard  
1882; 391 pp.

\$3.95 postpaid

from:  
Charles E. Tuttle Co., Inc.  
Rutland, Vermont 05701

OR  
WHOLE EARTH CATALOG

**Pioneer Posters**

Cheap, good, educational, weird. They're a whole other kind of history than book history and better posters than most posters. Immense variety.

Catalog \$0.10

from:  
Pioneer Historical Society  
Harriman, Tennessee 37748



- C140—TRAVEL POSTER—1854—boats traveled inland & connected with railroads, illustrated 17" x 11" 25g
- C141—LINCOLN ELECTION BROADSIDE—picture Lincoln & Copperhead snake, unusual 17" x 11" 20g
- C142—LINCOLN—pencil sketch 3/27/65 shortly before death, fine study 10g
- C143—BILL OF SALE—SLAVE—1667—Mass. colony—very early document 20g
- C144—BALLAD—1844—handbill. Famous murder Rhode Island, unique worthy framing 35g
- C145—RECIPE—how make bad husband, good 1795 almanac 10g
- C146—STEAM MOTOR CAR—Handbill—1888—illustrated—oddy 15g
- C147—STEAM BUGGY—1870 handbill, illustrated. Will outspeed horse 15g
- C148—STEAM WAGON—1867—illustrated, one of the earliest autos 25g
- C149—HISTORIC NEWS—set of 4 front pages—1. 1863; 2. Lincoln shot; 3. Spanish-Amer. War; 4. 1931 Depression prices. Entire set 50g
- C150—AUCTION SALE LOTS—1843—Brooklyn—large—rare 40g
- C151—PLEDGE OF ALLEGIANCE—signed by G. Washington at Valley Forge 1778, rare 20g
- C152—GETTYSBURG ADDRESS in Lincoln's handwriting 15g
- C153—MENU—May 2, 1865, black border. A Nation in Tears, mourns Lincoln 15g
- C154—TEXAS DECLARATION INDEPENDENCE—1836—13 x 9 1/2 25g
- C155—TEXAS RECRUITING immediately armed & 25g
- C156—GEN'L GRANT to LI 25g
- C157—GEN'L LEE orders 25g
- C158—COMMISSION appo 1775—rare 25g
- C159—MAYFLOWER COMP Plymouth 25g
- C160—BILL OF SALE—181 by Gov. Price, 17 x 1 1/2 25g
- C161—WASHINGTON SILH made from life, rare 25g
- C162—LINCOLN FUNERAL casket advertised w/ Rare oddy 35g
- C163—AMER. REVOLUTIONI Phila. Coffee House, 1 25g
- C164—STAR SPANGLED B —Rare 15g
- C165—MORMON BROADSII strations—circulated 25g
- C166—INTEGRATION PROE future—all negro exc all negro football t toons only 25g
- C167—PATENT MEDICINE tiffle-table of cures, headache—use magne 25g
- C168—CUSTERS LAST S1 white, pat. medicine 25g
- C169—PAT. MEDICINE P medicine on horse 1 Circa 1840 18 1/2 25g
- C170—BROADSIDE—dated France, in English, 2 25g
- C171—BROADSIDE—dated rare 65g
- C172—JULY 4th POSTER—parody of celebration Civil War period 25g
- C173—AUCTION POSTER— 25g

**NEW COMPANY RULES**

- Office employees will daily sweep the floors, dust the furniture, shelves and showcases.
- Each draftsman will bring in a bucket of water and a scuttle of coal for the day's business.
- Draftsmen will each day fill lamps, clean chimneys, trim wicks. Wash the windows once a week.
- Make your pens carefully. You may whittle nibs to your individual taste.
- This office will open at 7 A.M. and close at 8 P.M. daily, except on the Sabbath, on which day it will remain closed.
- Man employees will be given an evening off each week for courting purposes, or two evenings a week if they go regularly to church.
- Every employee should lay aside from each pay a goodly sum of his earnings for his benefits during his declining years, so that he will not become a burden upon the charity of his betters.
- Any employee who smokes Spanish cigars, uses liquor in any form, gets shaved at a barber shop, or frequents pool or public halls, will give me good reason to suspect his worth, intentions, integrity and honesty.
- The employee who has performed his labors faithfully and without fault for a period of five years in my service, who has been thrifty and attentive to his religious duties, and is looked upon by his fellow men as a substantial and law abiding citizen, will be given an increase of five cents per day in his pay, providing a just return of profits from the business permits it.

**AT THE PRINCESS**

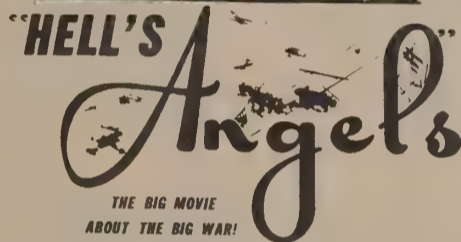

THE BIG MOVIE ABOUT THE BIG WAR!  
DIRECTED BY HOWARD HUGHES  
STARRING Ben Lyon, Jean Harlow, James Hall  
Saturday Is Positively the Last Day

**A GRAND EXHIBITION OF THE EFFECTS PRODUCED BY INHALING NITROUS OXIDE, EXHILERATING, OR LAUGHING GAS!**

WILL BE GIVEN AT The Harmon Hall  
Saturday Evening, 15th 1846.

30 GALLONS OF GAS will be prepared and administered to all in the audience who desire to inhale it.

MEN will be invited from the audience, to protect those under the influence of the Gas from injuring themselves or others. This course is adopted that no apprehension of danger may be entertained. Probably no one will attempt to fight.

THE EFFECT OF THE GAS is to make those who inhale it, either LAUGH, SING, DANCE, SPEAK OR FIGHT, &c. &c.

according to the leading trait of their character. They seem to retain consciousness enough not to say or do that which they would have occasion to regret.

N. B. The Gas will be administered only to gentlemen of the first respectability. The object is to make the entertainment in every respect, a genteel affair.

Those who inhale the Gas once, are always anxious to inhale it the second time. There is not an exception to this rule.

No language can describe the delightful sensation produced. Robert Southey, (poet) once said that "the atmosphere of the highest of all possible heavens must be composed of this Gas."

For a full account of the effect produced upon some of the most distinguished men of Europe, see Hooper's Medical Dictionary, under the head of Nitrogen.

- C193—BROADSIDE, 1750, Mass.—Murderer speaks on execution day; Ballad; oddy 40g
- C194—MASS. BAY COLONY, 1711—Orders soldiers not to desert—Impt. 35g
- C195—NEW ENGLAND PROCLAMATION—Oct. 17, 1706 THANKSGIVING day, gives reasons 50g
- C196—MASS. BAY COLONY, 1711—warning about desertion 35g
- C197—1703 POSTER—Queen orders colonies not to trade France, Spain. Rare 50g

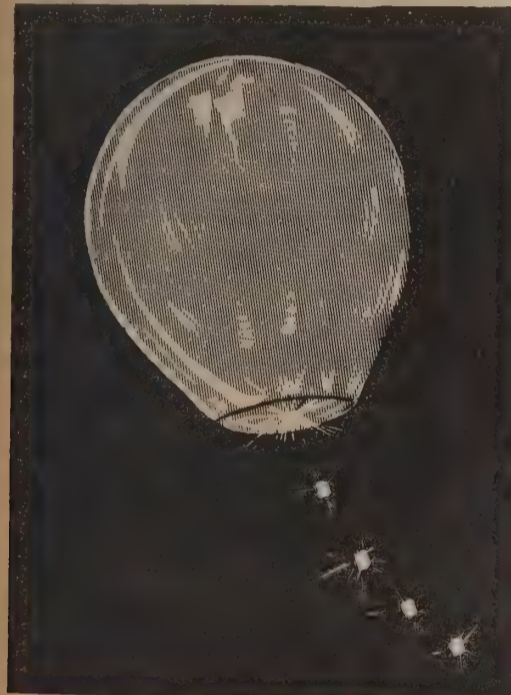

FIG. 100. Top View of Hoop and Cross Wire. Wick-ball. Side View of Hoop showing Wick ball hung in place.

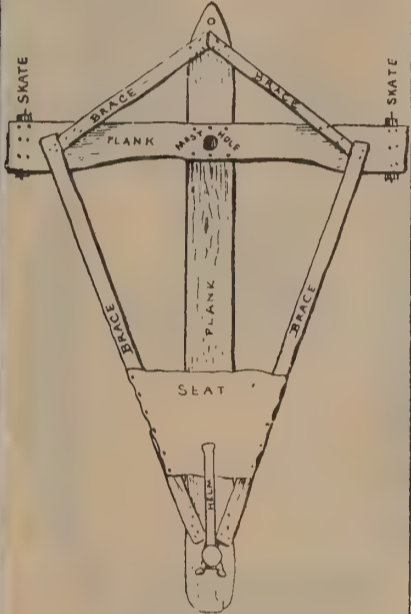
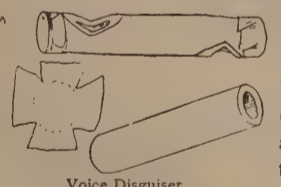

FIG. 188.—Top View of Ice-Boat.

**The Voice Disguiser**

is made of a piece of corn-stalk about three inches long. After removing the pith cut a notch near each end, as shown in the illustration, upon opposite sides of the corn-stalk; upon the ends stretch a piece of fish-bladder, or any thin membrane; a piece of thin tracing-paper will answer. With a large pin make a hole in each piece of membrane, as shown at A in the illustration. Now cover the notch, cut into the corn-stalk, with your mouth and laugh; the noise you produce will set you laughing in earnest. By placing your mouth over either of the notches and talking or singing, the voice is so changed as to be perfectly disguised, and if you sing a song through this instrument it sounds like some one playing on a comb covered with paper. The voice disguiser is very handy in Punch and Judy or puppet shows.



Voice Disguiser.

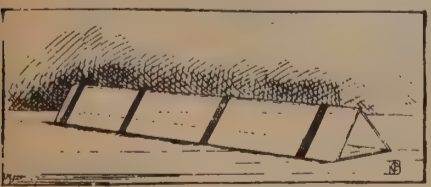

FIG. 213—Kaleidoscope.

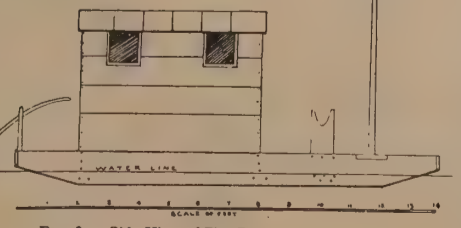

FIG. 8x.—Side View of Flat-Boat.

Set a seat in front of the rowlock with a hole in it for the "jack-staff" to pass through. The jack-staff should be made so that it can be taken out and put in at pleasure. This can be done by ...

**1d Reward Posters**

On fine finish white paper, suitable for framing. 12 posters, all different at 50 cents each, or the entire set of 12 posters for only \$2—while supply lasts.

! CLOSE

The following are limited Learning 57

- 36—CUSTER'S LAST SHOT—Inclu

**Sense Relaxation**

Becoming comfortable with touch requires patience and awareness. Experience what your attitudes are, how you touch, what your feelings are. Slowly, if you desire, you can change these reactions and allow yourself to enjoy touching not only others, but the floor, yourself, paper, food, trees, animals, flowers, life.



This is a book which is an experience while it teaches you how to have additional experiences. It is a combination of simple straight forward how-to-do-it prose broken by puns (to slow down your reading) plus sensual photographs of every exercise. Your first time through this book you will only glance at the words; the pictures are so compelling. The second and third times through you will read individual sections to find out what the pictures suggest. Finally you will begin to use this book to add touch, relaxation and pleasure to your life. This book gives very specific and easily followed exercises for individuals, couples, and groups to tune in to their own bodies and to all their senses. Gunther gives suggestions and techniques to energize, to tranquilize, and above all to increase awareness. It is a beautifully designed and executed book.

[James Fadiman]



**Sense Relaxation — Below Your Mind**

Bernard Gunther, photographed by Paul Fusco 1968: 191 pp.

from: Collier Books 866 Third Avenue New York, N.Y. 10022

\$2.95 postpaid

or most book stores.



Most people are half breathers, keeping residual air in their lower lungs; they are unable to take a full deep breath even if they want to. To breathe deeper you must exhale more. Yelling gets out all the old air and some of those held-in feelings; let yourself be open-air.

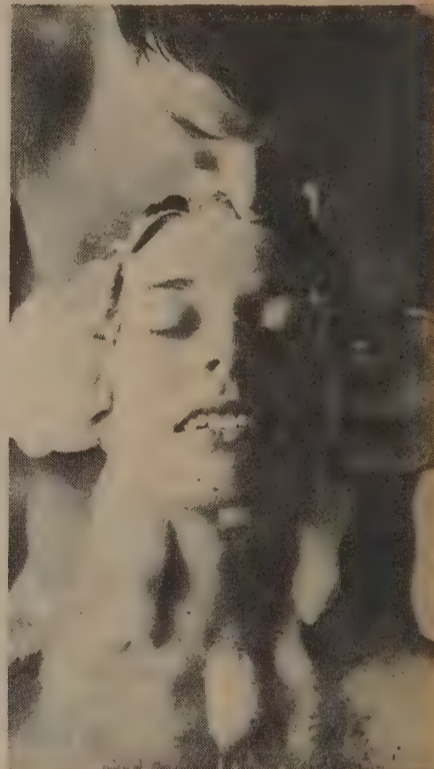

**Zen Flesh, Zen Bones**

A Collection of Zen and Pre-Zen Writings compiled by Paul Reps

101 Zen Stories  
The Gateless Gate  
10 Bulls  
Centering

Whose Zen do you like, Suzuki's, Blythe's, yours? Reps is best at yours.

**Zen Flesh, Zen Bones**

ed. Paul Reps 1961; 175 pp.

\$ .95 postpaid

from: Doubleday & Company 501 Franklin Ave. Garden City L.I., N.Y. 11531 or WHOLE EARTH CATALOG



If you like sweets and easy living, skip this book. It is about men tremendously intent on being reborn, on satori, enlightenment. It can happen to you. In a flashing moment something opens. You are new all through. You see the same unsame world with fresh eyes.

- 5. Consider your essence as light rays rising from center to center up the vertebrae, and so rises livingness in you.
- 6. Or in the spaces between, feel this as lightning.
- 7. Devi, imagine the Sanskrit letters in these honey-filled foci of awareness, first as letters, then more subtly as sounds, then as most subtle feeling. Then leaving them aside, be free.
- 8. Attention between eyebrows, let mind be before thought. Let form fill with breath-essence to the top of the head, and there shower as light.
- 9. Or, imagine the five-colored circles of the peacock tail to be your five senses in illimitable space. Now let their beauty melt within. Similarly, at any point in space or on a wall—until the point dissolves. Then your wish for another comes true.
- 63. When a moonless raining night is not present, close eyes and find blackness before you. Opening eyes, see blackness. So faults disappear forever.
- 68. Pierce some part of your nectar-filled form with a pin, and gently enter the piercing.

**What is Zen?**

One answer: Inayat Khan tells a Hindu story of a fish who went to a queen fish and asked: "I have always heard about the sea, but what is this sea? Where is it?" The Queen fish explained: "You live, move, and have your being in the sea. The sea is within you and without you, and you are made of sea, and you will end in sea. The sea surrounds you as your own being."

Another answer:

**Meditation Cushions and Mats**

Started by Alexandra Jacopetti, the Dharma Pillow Works has recently been sold to The San Francisco Zen Center. The product is the same, traditionally designed softness for your hard edges.

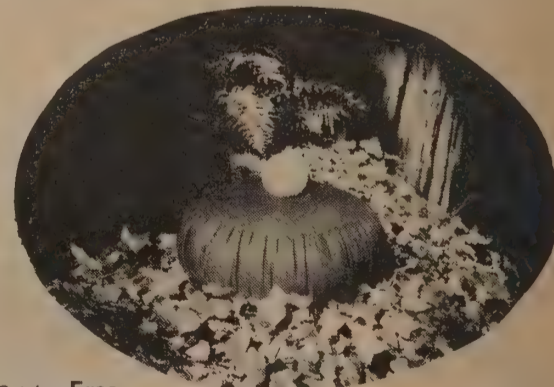

Catalog Free.

Zafu \$4.25 complete \$2.25 unstuffed Available in 5-6" height, 4-5" height, or to order. Fabric is traditional black cotton or to order.

Zabuton (mat for added height and ease on knees) \$5.75

Also available: double Zabuton, baby mat, yoga mat, sleep mat, camping mat.

Groups, etc. purchasing six or more items get a 12% discount.

Order from Dharma Pillow Works 455 Fourteenth Street San Francisco, Ca 94103

## Self Hypnotism

*One of the things that intrigues me most about hypnotism is that no one knows how it works—which accounts for some of its disrepute. No common factors, for example, have been found to pre-distinguish susceptibles from non-susceptibles. Black box business*

*Lecron doesn't talk about any of this. He's concerned with how you can detect and de-suggest old imprinted hang-ups and suggest in new ones you like better. (One subject suggested herself larger breasts, and got them.)*

*Possibly the most general use of this book is its clear delineation of a simple avenue in—a meditative technique without much dogma. There's a lot of hypnosis books; this is the best we've seen.*

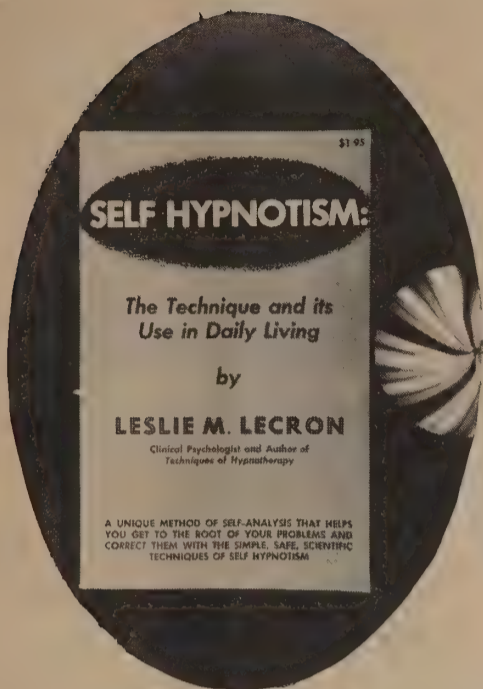

### Self Hypnotism

Leslie M. Lecron  
1964; 220 pp.

**\$1.95** postpaid

from:  
Prentice-Hall, Inc.  
Englewood Cliffs  
New Jersey 07631  
or  
WHOLE EARTH CATALOG

## Psycho-cybernetics

*This strange and gaudy volume will probably turn you off if you associate wisdom with subdued writing or humble exposition. However, if you can overcome your initial resistance to the high-pressure, breezy style and the sometimes excessive claims, it will be worth the effort. Dr. Maltz has outlined perhaps the easiest program of personality development and modification in print. It is easy because it contains nothing but the suggested exercises and the understanding that the motivation to change is still the most powerful tool.*

*This is not a book to read. It is a kit of tools to use in gaining control of your nature for whatever ends you desire. The author has made it clear that there is no virtue in being obscure or even in being poetic if it detracts from getting the reader off his ass and doing something about himself.*

*There is an assumption of a higher self or a core to one's being which tends toward realization or whatever term you prefer but understanding of this inner nature is not vital to using the book.*

What we need to understand is that these habits, unlike addictions, can be modified, changed, or reversed, simply by taking the trouble to make a conscious decision—and then by practicing or "acting out" the new response or behavior.

Simple? Yes. But each of the above habitual ways of acting, feeling, thinking does have beneficial and constructive influence on your self-image. Act them out for 21 days. 'Experience' them and see if worry, guilt, hostility have not been diminished and if confidence has not been increased.

So, why not give yourself a face lift? Your do-it-yourself kit consists of relaxation of negative tensions to prevent scars, therapeutic forgiveness to remove old scars, providing yourself with a tough (not a hard) epidermis instead of a shell, creative living, a willingness to be a little vulnerable, and a nostalgia for the future instead of the past.

*If the above puts you off than this is not the book for your use. If this totally western way of dealing with yourself interests you, this book is far better than most of the other pop-enlightenment books around.*

[Suggested and reviewed by James Fadiman]

### Psycho-cybernetics

Maxwell Maltz, M.D.  
1960; 256 pp.

**\$2.00** postpaid

from:  
Melvin Powers  
8721 Sunset Boulevard  
Hollywood, Ca. 90069

or **\$1.00** postpaid

from:  
Essandess Special Editions  
Simon & Schuster  
630 Fifth Avenue  
New York, N.Y. 10020

or most book stores

Now that you are comfortable you will listen closely to my voice and will follow all the suggestions given. This will teach you how to enter hypnosis and how to produce it yourself. Your eyes are now closed. Take another deep breath, hold it a few seconds and let it out.

The more you can relax, the deeper you will be able to go into hypnosis. Let all your muscles go as loose and limp as possible. To do this start with your right leg. Tighten the muscles first, making the leg rigid. Then let it relax from your toes up to your hip. Then tighten the muscles of the left leg. Let that leg relax from the toes up to the hip.

Let the stomach and abdominal area relax; then your chest and breathing muscles. The muscles of your back can loosen—your shoulders and neck muscles relaxing. Often we have tension in this area. Let all these muscles loosen. Now your arms from the shoulders right down to your finger tips. Even your facial muscles will relax. Relaxation is so pleasant and comfortable. Let go completely and enjoy the relaxation. All tension seems to drain away and you soon find a listlessness creeping over you, with a sense of comfort and well-being.

As you relax more and more, you will slip deeper and deeper into hypnosis. Your arms and legs may develop a feeling of heaviness. Or instead you may find your whole body feeling very light, as though you are floating on a soft cloud.

Now imagine that you are standing at the top of an escalator such as those in some stores. See the steps moving down in front of you, and see the railings. I am going to count from ten to zero. As I start to count, imagine you are stepping on the escalator, standing there with your hands on the railing while the steps move down in front of you taking you with them. If you prefer, you can imagine a staircase or an elevator instead. If you have any difficulty visualizing the escalator or staircase or elevator, just the count itself will take you deeper and deeper.

(Slowly) TEN—now you step on, and start going down. NINE—EIGHT—SEVEN—SIX. Going deeper and deeper with each count. FIVE—FOUR—THREE. Still deeper. TWO—ONE—and ZERO. Now you step off at the bottom and will continue to go deeper still with each breath you take. You are so relaxed and comfortable. Let go still more. Notice your breathing. Probably it is now slower and you are breathing more from the bottom of your lungs, abdominal breathing.

In a moment you will notice your hand and arm are beginning to lose any feeling of heaviness and are becoming light. If you are right-handed, it will be your right arm, if left-handed, it will be the left.

The arm is getting lighter and lighter. It will begin to lift. Perhaps just the fingers will move first, or the whole hand will start to float up. It will float toward your face, as though your face was a magnet pulling it up until the fingers touch your face someplace. Let's see where that will be. The arm begins to bend at the elbow. It is floating upward. If it has not started of its own accord, lift it voluntarily a few inches to give it a start. It will continue to go up of its own accord with no further effort. It floats on up toward your face, higher and higher. The higher your hand goes the deeper you will go. The deeper you go, the higher the hand will go. Lifting, lifting, floating up higher and higher. Going higher and higher. Now if it has touched your face let your hand go down to any comfortable position. If it has not touched yet, it can continue to float up until it does touch. You can forget about the arm while I tell you how you can put yourself into hypnosis whenever you may wish to do so.

You will use much the same method being used now. When you have made yourself comfortable, you will merely close your eyes and drift into hypnosis. But in your first three or four practice sessions it would help you if you first lit a candle and when you have made yourself comfortable would look at the flickering flame for two or three minutes. Then close your eyes.

Then you will think to yourself the phrase, "Now I am going into hypnosis." Then repeat to yourself the words, "Relax now" three times, saying them very slowly. As you do this you will slip off into hypnosis. You say nothing aloud, you merely think these words. When you have done this, take another deep breath to help you relax more and go through the relaxation just as you have done before. Tell your muscles to relax as I have done.

When you have finally relaxed your arms, imagine the escalator, elevator or staircase. Now you should count backward from ten to zero, including the zero. Count slowly. In your first four practice sessions repeat the count three times, as though going down different levels. With practice you need only count once.

Whenever you are ready to awaken all you need to do is think to yourself, "Now I am going to wake up." Then count slowly to three and you will be wide awake. You will always awaken refreshed, relaxed and feeling fine.

While you are in hypnosis if something should happen so you should awaken, you will do so instantly and spontaneously—something such as the phone ringing or a real emergency like a fire. You will awaken instantly and be wide awake and fully alert. Actually this would happen without such a suggestion being necessary, for your subconscious mind always protects you.

Now I will count to three and you will be wide awake. If convenient you should then go through this formula for self-hypnosis and put yourself back in. You will remember the formula and go through it exactly as given. Now, awaken as I count. ONE. Coming awake now. TWO—almost awake. THREE—now you are wide awake. Wide awake.

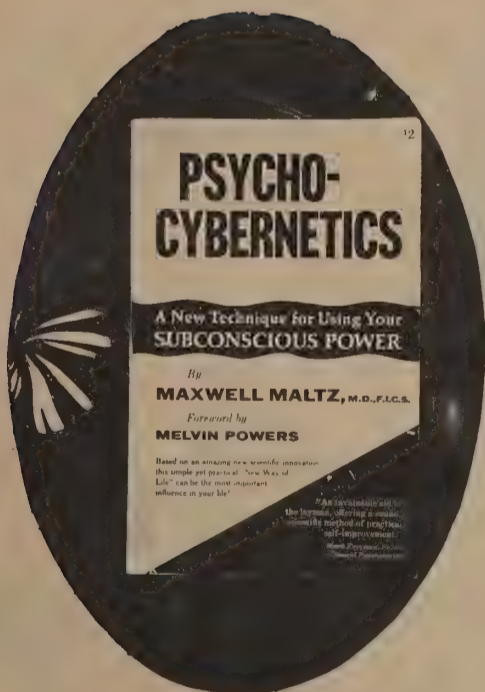

**A Yaqui Way of Knowledge**

*This book records the experiences of an anthropology student who becomes the apprentice of don Juan, a Yaqui indian "man of knowledge" who is also a "diablero", a black sorcerer. It is a profoundly disturbing book since it opens up areas and ideas we usually dismiss or deny. Don Juan, over a period of five years, teaches the author a little of his knowledge. He teaches through giving his apprentice various psycho-active plants: peyote, datura, and a mixture of psilocybin mushrooms, genista canariensis, and other plants. Each of these plants has its own way of teaching, its own demands and its own kind of power. For those of us who thought we understood psychedelic effects this book reveals the rudimentary state of our knowledge. For those of us who have dismissed magic as a combination of hypnotism and stage effects we are confronted with powerful and effective magic which seems irrefutable.*

*Don Juan himself appears as a powerful, indecipherable, wise man whose knowledge is both extensive and alien to our own. He offers to each of us the possibility of dealing with other realities, but he makes it clear that all these ways are dangerous, difficult and once entered, cannot be put aside as simply another experience.*

*The goal of his teaching is partially expressed as follows:*

The particular thing to learn is how to get to the crack between the worlds and how to enter the other world. There is a crack between the two worlds, the world of the diableros and the world of living men. There is a place where these two worlds overlap. The crack is there. It opens and closes like a door in the wind. To get there a man must exercise his will. He must, I should say, develop an indomitable desire for it, a single-minded dedication. But he must do it without the help of any power or any man...

*Not a book to be read for pleasure, a book which will effect you more than you may wish to be effected.*

[Reviewed by James Fadiman]

*(Why not read it for pleasure? It's frontier Boswell and Johnson. —SB)*

"Don't get me wrong, don Juan," I protested. "I want to have an ally, but I also want to know everything I can. You yourself have said that knowledge is power."  
"No!" he said emphatically. "Power rests on the kind of knowledge one holds. What is the sense of knowing things that are useless?"

He looked at me for a long time and laughed. He said that learning through conversation was not only a waste, but stupidity, because learning was the most difficult task a man could undertake. He asked me to remember the time I had tried to find my spot, and how I wanted to find it without doing any work because I had expected him to hand out all the information. If he had done so, he said, I would never have learned. But, knowing how difficult it was to find my spot and, above all, knowing that it existed, would give me a unique sense of confidence. He said that while I remained rooted to my "good spot" nothing could cause me bodily harm, because I had the assurance that at that particular spot I was at my very best. I had the power to shove off anything that might be harmful to me. If, however, he had told me where it was, I would never have had the confidence needed to claim it as true knowledge. Thus, knowledge was indeed power.

Once a man has vanquished fear, he is free from it for the rest of his life because, instead of fear, he has acquired clarity—a clarity of mind which erases fear. By then a man knows his desires; he knows how to satisfy those desires. He can anticipate the new steps of learning, and a sharp clarity surrounds everything. The man feels that nothing is concealed. And thus he has encountered his second enemy: Clarity! That clarity of mind, which is so hard to obtain, dispels fear, but also blinds.

"I say it is useless to waste your life on one path, especially if that path has no heart."  
"But how do you know when a path has no heart, don Juan?"  
"Before you embark on it you ask the question Does this path have a heart? If the answer is no, you will know it, and then you must choose another path."  
"But how will I know for sure whether a Path has a heart or not?"  
"Anybody would know that. The trouble is nobody asks the question; and when a man finally realizes that he has taken a path without a heart the path is ready to kill him. At that point very few men can stop to deliberate, and leave the path."  
"How should I proceed to ask the question properly, don Juan?"  
"Just ask it."  
"I mean, is there a proper method, so I would not lie to myself and believe the answer is yes when it really is no?"  
"Why would you lie?"  
"Perhaps because at the moment the path is pleasant and enjoyable."  
"That is nonsense. A path without a heart is never enjoyable. You have to work hard even to take it. On the other hand, a path with heart is easy; it does not make you work at liking it."

You have the vanity to believe you live in two worlds, but that is only your vanity. There is but one single world for us. We are men, and must follow the world of men contentedly.

"But is this business of the dog and me pissing on each other true?"  
"It was not a dog! How many times do I have to tell you that? This is the only way to understand it. It's the only way! It was 'he' who played with you."

"Let's put it another way, don Juan. What I meant to say is that if I had tied myself to a rock with a heavy chain I would have flown just the same, because my body had nothing to do with my flying." Don looked at me incredulously. "If you tie yourself to a rock," he said, "I'm afraid you will have to fly holding the rock with its heavy chain."

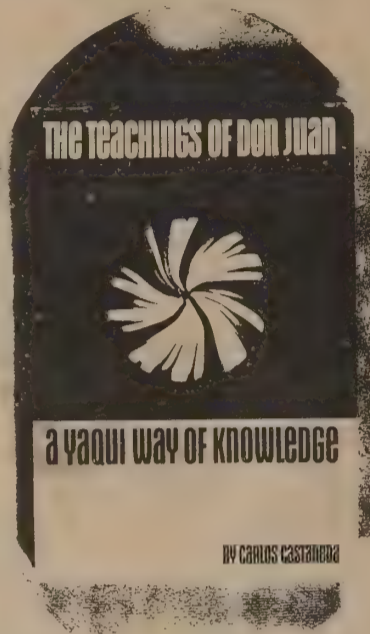

**The Teachings of Don Juan: A Yaqui Way of Knowledge**

Carlos Castaneda from: Room 701  
1968; 196 pp. University of California Press 25 West 45th Street  
2223 Fulton Street New York, N.Y. 10036  
\$5.95 postpaid Berkeley, Ca 94720 or  
WHOLE EARTH CATALOG

**Fundamentals of Yoga**

*Mishra has practised as general physician, surgeon and endocrinologist in India and the West and has a thorough knowledge of Western medicine as well as yoga. This makes his book invaluable to the student desiring a detailed scientific understanding of yogic theory and methods. The book contains several interesting diagrams of physical systems and psycho-physical planes of consciousness.*

*Being a practising teacher of yoga, Mishra writes in a forthright direct style and gives, in each chapter, exercises arranged in numbered steps, to practice the methods described. The physical, or hatha yoga methods are described in some detail, though still only as preparatory to the other meditative types of exercises. Methods not usually described in other works on yoga—such as tratakam (concentrated gazing) and nadam (tuning in to inner sound-vibration) are also taught and given extensive treatment. There are chapters on "Techniques to Magnetize the Body", "Group Relaxation and Group Magnetism", "Postoperative and Post-meditative Suggestion", "Anesthesia Produced by Yoganidra", "Heal Yourself by Your Own Hormones and Tranquillizers" et al.*

*One might find fault with the book's somewhat excessive load of Hindu terminology, much of which is redundant, and of more interest to students of Indian culture than to practitioners.*

*This is probably the best book for those professionals and laymen who want to apply yogic techniques in physical and psycho-therapy both for themselves and others.*

[Suggested and Reviewed by Ralph Metzner]

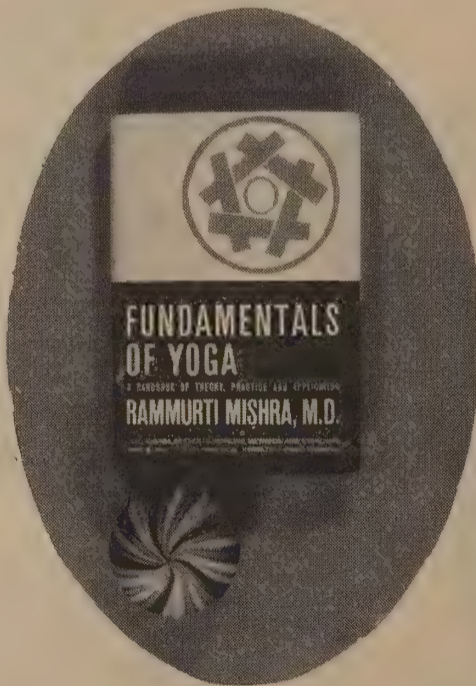

"Now you are in your native land. Now you do not know where your body is. The entire universe is in you and you are in the entire universe. Innumerable suns, stars, and planets are moving in you. Feel it, enjoy your real life." Complete silence.

1. Adopt an easy posture.
2. Relax your entire body.
3. Feel your heart pumping in the chest.
4. Hold your breath.
5. In a moment you will feel that heart rate and vigor of beat are increased.
6. With every heartbeat, the heart is sending energy to every part of the body. Feel it.
7. With increased heart rate and beat, energy is changed into electromagnetic pulsation and the entire body is filled with it. Feel it.
8. The entire is now magnetized, and the spiritual heart and spiritual consciousness are fully manifested in you. Feel them.
9. The whole body becomes the heart of the universe, and you feel that the entire body is pulsating as a single heart.
10. Gradually you forget the feelings of the physical body and you identify yourself completely with supreme consciousness.
11. Now you know that your consciousness is never a product of the body, but is manifested in the body.
12. Feel that your body is one point of manifestation of consciousness, but really you are everywhere. . . . .

There are innumerable varieties of nadam, but they will be impractical for beginners. The following ten are the most useful and frequent:

1. Cin nadam: Like the hum of the honey-intoxicated bees; idling engine vibration; rainfall; whistling sounds; high frequency sound.
2. Cincin nadam: Waterfall, roaring of an ocean.
3. Ghanta nadam: Sound of a bell ringing.
4. Sankha nadam: Sound of a conch shell.
5. Tantri vina: Nasal sound, humming sound like that of a wire string instrument
6. Tala nadam: Sound of a small tight drum.
7. Venu nadam: Sound of a flute.
8. Mridamga: Sound of a big bass drum.
9. Bheri nadam: Echoing sound.
10. Megha nadam: Roll of distant thunder.

**Fundamentals of Yoga**

Rammurti Mishra  
1959; 255 pp.

\$5.00 postpaid

from:  
The Julian Press, Inc.  
Lyle Stuart  
239 Park Avenue South  
New York, N.Y.



## The Act of Creation

Koestler takes his notion of bisociation to be the root of humor, discovery, and art. I take it to be one of the roots of learning, subject to applications of method (on yourself or whomever).

Koestler is a scientist of some reputation by now. He's made contributions beyond the work of others that he's generalized from. This is the book that gave him the reputation.

There are two ways of escaping our more or less automatized routines of thinking and behaving. The first, of course, is the plunge into dreaming or dream-like states, when the codes of rational thinking are suspended. The other way is also an escape—from boredom, stagnation, intellectual predicaments, and emotional frustration—but an escape in the opposite direction; it is signaled by the spontaneous flash of insight which shows a familiar situation or event in a new light, and elicits a new response to it. The bisociative act connects previously unconnected matrices of experience; it makes us 'understand what it is to be awake, to be living on several planes at once' (to quote T.S. Eliot, somewhat out of context).

The first way of escape is a regression to earlier, more primitive levels of ideation, exemplified in the language of the dream; the second an ascent to a new, more complex level of mental evolution. Though seemingly opposed, the two processes will turn out to be intimately related.

When two independent matrices of perception or reasoning interact with each other the result (as I hope to show) is either a **collision** ending in laughter, or their **fusion** in a new intellectual synthesis, or their **confrontation** in an aesthetic experience. The bisociative patterns found in any domain of creative activity are tri-valent: that is to say, the same pair of matrices can produce comic, tragic, or intellectually challenging effects.

The re-structuring of mental organization effected by the new discovery implies that the creative act has a revolutionary or **destructive** side. The path of history is strewn with its victims: the discarded isms of art, the epicycles and phlogistons of science.

Associative skills, on the other hand, even of the sophisticated kind which require a high degree of concentration, do not display the above features. Their biological equivalents are the activities of the organism while in a state of dynamic equilibrium with the environment—as distinct from the more spectacular manifestations of its regenerative potentials. The skills of reasoning rely on habit, governed by well-established rules of the game; the 'reasonable person'—used as a standard norm in English common law—is level-headed instead of multi-level-headed; adaptive and not destructive; an enlightened conservative, not a revolutionary; willing to learn under proper guidance, but unable to be guided by his dreams.

The main distinguishing features of associative and bisociative thought may now be summed up, somewhat brutally, as follows:

Habit	Originality
Association within the confines of a given matrix	Bisociation of independent matrices
Guidance by pre-conscious or extra-conscious processes	Guidance by sub-conscious processes normally under restraint
Dynamic equilibrium	Activation of regenerative potentials
Rigid to flexible variations on a theme	Super-flexibility (reculer pour mieux sauter)
Repetitiveness	Novelty
Conservative	Destructive-Constructive

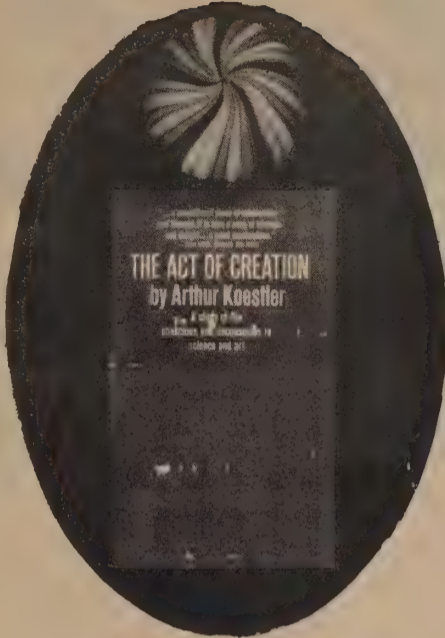

### The Act of Creation

Arthur Koestler  
1964; 750 pp.

\$1.25 postpaid

from:  
Dell Publishing Company, Inc.  
750 Third Avenue  
New York, N.Y. 10017

or most book stores.

I have coined the term 'bisociation' in order to make a distinction between the routine skills of thinking on a single 'plane', as it were, and the creative act, which, as I shall try to show, always operates on

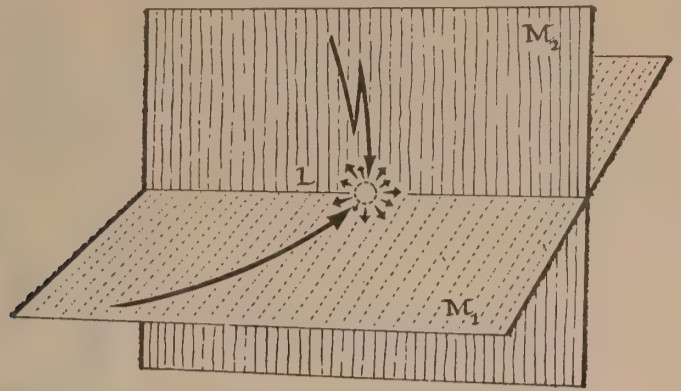

more than one plane. The former may be called single-minded, the latter a double-minded, transitory state of unstable equilibrium where the balance of both emotion and thought is disturbed.

Everybody can ride a bicycle, but nobody knows how it is done. Not even engineers and bicycle manufacturers know the formula for the correct method of counteracting the tendency to fall by turning the handlebars so that 'for a given angle of unbalance the curvature of each winding is inversely proportional to the square of the speed at which the cyclist is proceeding'. The cyclist obeys a code of rules which is specifiable, but which he cannot specify; he could write on his number-plate Pascal's motto: 'Le cœur a ses raisons que la raison ne connaît point.' Or, to put it in a more abstract way:

The controls of a skilled activity generally function below the level of consciousness on which that activity takes place. The code is a hidden persuader.

This applies not only to our visceral activities and muscular skills, but also to the skill of perceiving the world around us in a coherent and meaningful manner. Hold your left hand six inches, the other twelve inches, away from your eyes; they will look about the same size, although the retinal image of the left is twice the size of the right. Trace the contours of your face with a soapy finger on the bathroom mirror (it is easily done by closing one eye). There is a shock waiting: the image which looked life-size has shrunk to half-size, like a head-hunter's trophy. A person walking away does not seem to become a dwarf—as he should; a black glove looks just as black in the sunlight as in shadow—though it should not; when a coin is held before the eyes in a tilted position its retinal projection will be a more or less flattened ellipse; yet we see it as a circle, because we know it to be a circle; and it takes some effort to see it actually as a squashed oval shape. Seeing is believing, as the saying goes, but the reverse is also true: knowing is seeing. 'Even the most elementary perceptions,' wrote Bartlett, 'have the character of inferential constructions.' But the inferential process, which controls perception, again works unconsciously. Seeing is a skill, part innate, part acquired in early infancy. The selective codes in this case operate on the input, not on the output. The stimuli impinging on the senses provide only the raw material of our conscious experience—the 'booming, buzzing confusion' of William James; before reaching awareness the input is filtered, processed, distorted, interpreted, and reorganized in a series of relay-stations at various levels of the nervous system; but the processing itself is not experienced by the person, and the rules of the game according to which the controls work are unknown to him.

## The I Ching

*The I Ching, the Book of Changes, is a brilliant problem-solving device. A problem (or ignorance) generally consists of being caught in local cyclic thinking. To consult the oracle, the wisdom of chance (or synchronicity, no matter), is to step out of the cycle of no-change and address a specific story on the nature of change. You now have an alternative set of solutions that owe nothing but proximity to your problem. You make the associations, you find the way out. It's prayer.*

*I can't think of a more important and useful book than this one. It's famously ancient, poetic, deep, esoteric, simple, involving. It has been the most influential book on American art and artists in the last 15 years.*

*Most people know about it. We've included it here to point at the new smaller (unabridged) cheaper Princeton University Press version of the classic Wilhelm-Baynes Bollingen edition. The oracle method is still on page 721.*

### 49. Ko / Revolution ( Molting )

☰ above TUI The Joyous, Lake  
☷ below LI The Clinging, Fire

The Chinese character for this hexagram means in its original sense an animal's pelt, which is changed in the course of the year by molting. From this the word is carried over to apply to the "moltings" in political life, the great revolutions connected with changes of governments.

The two trigrams making up the hexagram are the same two that appear in K'uei, OPPOSITION (38), that is, the two younger daughters, LI and Tui. But while there the elder of the two daughters is above, and what results is essentially only an opposition of tendencies, here the younger daughter is above. The influences are in actual conflict, and the forces combat each other like fire and water (lake), each trying to destroy the other. Hence the idea of revolution.

THE JUDGMENT  
REVOLUTION. On your own day  
You are believed.  
Supreme success,  
Furthering through perseverance.  
Remorse disappears.

Political revolutions are extremely grave matters. They should be undertaken only under stress of direst necessity, when there is no other way out. Not everyone is called to this task, but only the man who has the confidence of the people, and even he only when the time is ripe. He must then proceed in the right way, so that he gladdens the people and, by enlightening them, prevents excesses. Furthermore, he must be quite free of selfish aims and must really relieve the need of the people. Only then does he have nothing to regret.

Times change, and with them their demands. Thus the seasons change in the course of the year. In the world cycle also there are spring and autumn in the life of peoples and nations, and these call for social transformations.

THE IMAGE  
Fire in the lake: the image of REVOLUTION.  
Thus the superior man  
Sets the calendar in order  
And makes the seasons clear.

Fire below and the lake above combat and destroy each other. So too in the course of the year a combat takes place between the forces of light and the forces of darkness, eventuating in the revolution of the seasons. Man masters these changes in nature by noting their regularity and marking off the passage of time accordingly. In this way order and clarity appear in the apparently chaotic changes of the seasons, and man is able to adjust himself in advance to the demands of the different times.

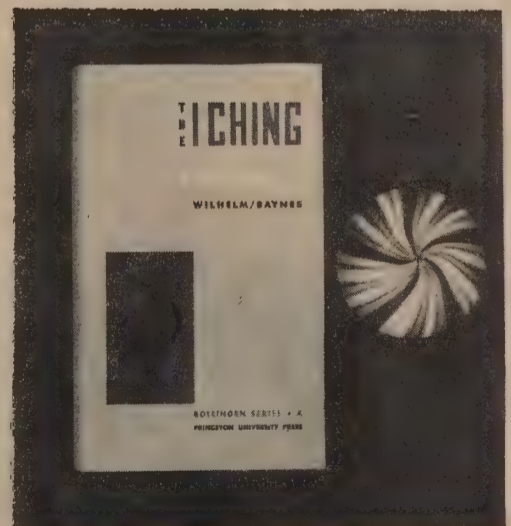

### The I Ching

Translated by Richard Wilhelm, Cary F. Baynes  
?B.C.; 740 pp.

\$6.00 postpaid

from:  
Princeton University Press  
Princeton, New Jersey 08540  
or  
WHOLE EARTH CATALOG

See Page 41

*THIS MAGAZINE is about*

P.O. BOX 876, TERMINAL 'A' / TORONTO 1 / 364-3333

# SCHOOLS

THE EDITORS OF THE HARVARD EDUCATIONAL REVIEW TAKE PLEASURE IN RECOMMENDING THIS MAGAZINE is about SCHOOLS

"WE RECOMMEND IT TO ALL PROFESSIONALS (TEACHERS, ADMINISTRATORS, PROFESSORS, PARENTS)." Saturday Review

"... SEEMS TO ME EASILY THE BEST, FRESHEST, AND MOST PENETRATING JOURNAL DEALING WITH EDUCATION THAT I HAVE SEEN IN YEARS." Edgar Z. Friedenberg

"SASSY AND PROVOCATIVE" The Christian Science Monitor

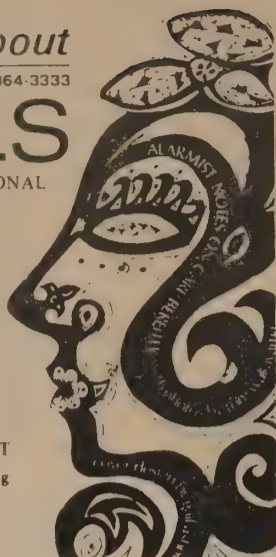

## SUBSCRIBE!

Please send me a subscription for  1 yr. \$ 3.50  
 3 yrs. 9.50  
 5 yrs. 15.00

Check enclosed

Bill Me

Name \_\_\_\_\_

Street \_\_\_\_\_

City \_\_\_\_\_ Prov. or State \_\_\_\_\_

Occupation \_\_\_\_\_

Send to: THIS MAGAZINE IS ABOUT SCHOOLS  
P.O. Box 876, Terminal 'A'  
Toronto 1, Ontario

See Page 53

# MODERN UTOPIAN

## /A WAY OUT

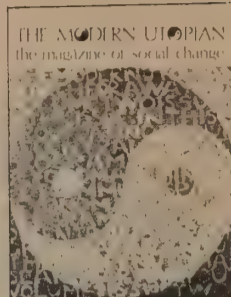

### Have You Heard About The Modern Utopian?

It's a magazine dedicated to social change agencies and intentional communities: a forum for the free flow of liberal and unorthodox ideas: a monthly report of significant events of significant movements for change in our society.

A Directory of Social Change is included free to subscribers. Contains listings of hundreds of social change agencies, intentional communities, psychedelic churches and scientific mate-matching services (limited supply available).

Latest Book and Record Reviews in every issue.

Send to: THE MODERN UTOPIAN, Starr King Center, 2441 Le Conte Avenue, Berkeley, California 94709.

Subscribe for 1 year (\$4.00) Name \_\_\_\_\_  
Enclosing \$7.00 for 2 years Address \_\_\_\_\_  
\$10.00 enclosed for 3 years City \_\_\_\_\_ State \_\_\_\_\_ Zip \_\_\_\_\_

Send gift subscription with my compliments to: (\$4.00 for 1st subscription; \$3.00 each additional).

Name \_\_\_\_\_ Name \_\_\_\_\_  
Address \_\_\_\_\_ Address \_\_\_\_\_  
City \_\_\_\_\_ State \_\_\_\_\_ Zip \_\_\_\_\_ City \_\_\_\_\_ State \_\_\_\_\_ Zip \_\_\_\_\_

Additional \$1.00 per year outside U. S.

# WHOLE EARTH TRUCK STORE

A four-dimensional edition of the WHOLE EARTH CATALOG may be found at 558 Santa Cruz, Menlo Park, California. It's called a Truck Store because it originally had wheels, and may again. Of the items listed in the CATALOG, most are in the Store, some available for direct purchase at CATALOG prices, others samples of what you may order by mail from suppliers. As new items are considered for the CATALOG they will appear in the Store

Hours: to be determined. Phone: 415 323-5155







send to: **WHOLE EARTH CATALOG**  
Portola Institute  
558 Santa Cruz, Menlo Park, California 94025

\_\_\_\_\_ amount enclosed

\$5 One issue of CATALOG \_\_\_ Fall \_\_\_ Spring

\$8 One year subscription: two CATALOGs and four Supplements

starting \_\_\_ Fall CATALOG \_\_\_ Jan Supplement \_\_\_ March Supplement

\_\_\_ Spring CATALOG \_\_\_ July Supplement \_\_\_ Sept Supplement

\$25 One year Retaining Subscription

\$100 One Year Sustaining Subscription

\_\_\_\_\_  
\_\_\_\_\_  
\_\_\_\_\_

zip

send to: **WHOLE EARTH CATALOG**  
Portola Institute  
558 Santa Cruz, Menlo Park, California 94025

\_\_\_\_\_ amount enclosed

\$5 One issue of CATALOG \_\_\_ Fall \_\_\_ Spring

\$8 One year subscription: two CATALOGs and four Supplements

starting \_\_\_ Fall CATALOG \_\_\_ Jan Supplement \_\_\_ March Supplement

\_\_\_ Spring CATALOG \_\_\_ July Supplement \_\_\_ Sep Supplement

\$25 One year Retaining Subscription

\$100 One year Sustaining Subscription

\_\_\_\_\_  
\_\_\_\_\_  
\_\_\_\_\_

zip



send to: **WHOLE EARTH CATALOG**  
Portola Institute  
558 Santa Cruz, Menlo Park, California 94025

\_\_\_\_\_ amount enclosed

\$5 One issue of CATALOG \_\_\_ Fall \_\_\_ Spring

\$8 One Year subscription: two CATALOGs and four Supplements

starting \_\_\_ Fall CATALOG \_\_\_ Jan Supplement \_\_\_ March Supplement

\_\_\_ Spring CATALOG \_\_\_ July Supplement \_\_\_ Sept Supplement

\$25 One year Retaining Subscription

\$100 One year Sustaining Subscription

\_\_\_\_\_  
\_\_\_\_\_  
\_\_\_\_\_

zip

# Understanding Whole Systems

Buckminster Fuller  
Cosmic View  
Full Earth  
Earth Photographs  
The World From Above  
Surface Anatomy  
Geology Illustrated  
Sensitive Chaos  
A Year From Monday

General Systems Yearbook  
Synthesis of Form  
On Growth and Form  
Tantra Art  
Psychological Reflections  
The Human Use of Human Beings  
The Ghost in the Machine  
The Year 2000  
The Futurist

# Shelter and Land Use

The Dymaxion World of Buckminster Fuller  
Space Structures  
Tensile Structures, Volume One  
Dome Cookbook  
Good News  
Architectural Design  
The Japanese House  
Audel Guides  
Alaskan Mill

Village Technology  
The Indian Tipi  
Tipis  
Aladdin Kerosene Lamps  
Man's Role in Changing the Face of the Earth  
Two Mushroom Books  
Organic Gardening  
ABC and XYZ of Bee Culture  
Universal Mill

# Industry and Craft

The Way Things Work  
Introduction to Engineering Design  
The Measure of Man  
Thomas Register of American Manufacturers  
New Scientist  
Scientific American  
Industrial Design  
Product Engineering  
Clearinghouse

Science and Civilization in China, Volume IV,  
Part 2  
Silvo Catalog  
Brookstone Tools  
Jensen Tools  
Miners Catalog  
Blasters' Handbook  
Direct Use of the Sun's Energy  
Structure, Form and Movement

Van Waters & Rogers  
Bookmaking  
Zone System Manual  
A Sculptor's Manual  
Creative Glass Blowing  
Buckskin  
Cut Beads  
Melrose Yarns

# Communications

Human Biocomputer  
The Mind of the Dolphin  
Information  
9100A Computer  
Cybernetics  
Eye and Brain  
Design for a Brain

Education Automation  
Intelligent Life in the Universe  
The McGraw-Hill Encyclopedia of Space  
Lafayette and Allied Catalogs  
Heathkit  
Modern Business Forms  
American Cinematographer

American Cinematographer Manual  
The Technique of Documentary Film Production  
The Technique of Television Production  
Auto Repair Manual  
Books  
Subject Guide to Books in Print  
Art Prints

# Community

The Modern Utopian  
The Realist  
Green Revolution  
Kibbutz: Venture in Utopia  
Dune  
Groups Under Stress

The Merck Manual  
Land for Sale  
Consumer Reports  
Government Publications  
The Armchair Shopper's Guide  
How to Get 20% to 90% Off on Everything You Buy

# Nomadics

Innovator  
The Retreater's Bibliography  
The Book of Survival  
The Survival Book  
Survival Arts of the Primitive Paiutes  
Camping and Woodcraft  
Light Weight Camping Equipment and How to Make It  
Backpacking  
L.L. Bean

Recreational Equipment  
Gerry Outdoor Equipment  
Kaibab Boots  
Hot Springs  
The Explorers Trademart Log  
National Geographic  
Sierra Club  
The Narrow Road to the Deep North  
Trout Fishing in America

# Learning

Toward a Theory of Instruction  
The Black Box  
THIS Magazine is about Schools  
Cuisenaire Rods  
ITA  
LIFE Science Library  
Kaiser Aluminum News  
700 Science Experiments for Everybody

Edmund Scientific  
WFF 'N PROOF  
Dr. Nim  
We Built Our Own Computers  
American Boys Handy Book  
Pioneer Posters  
Sense Relaxation  
Zen Flesh, Zen Bones

Meditation Cushions and Mats  
Self Hypnotism  
Psycho-cybernetics  
A Yaqui Way of Knowledge  
Fundamentals of Yoga  
The Act of Creation  
The I Ching

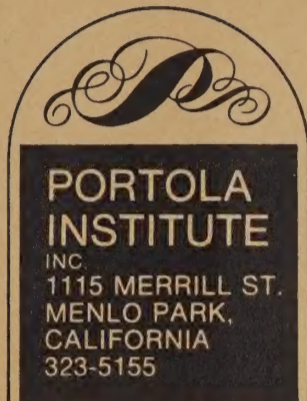

*The Whole Earth Catalog is one division of PORTOLA INSTITUTE, INC.  
Other present activities of the Institute include*

*Computer education for all grade levels  
Simulation games for classroom use  
New approaches in music education  
Ortage Park Teachers Laboratory*

*PORTOLA INSTITUTE was established in 1966 as a nonprofit corporation to encourage, organize, and conduct innovative educational projects. The Institute relies for support on private foundations and public agencies, to whom specific project proposals are submitted.*

*Because Portola Institute is a private organization with no need to produce profits or guarantee "success", it can experiment with new and unusual educational projects that would be difficult to administer within more structured organizations. For this reason the staff and facilities of the Institute are deliberately kept small and flexible.*

*Within its framework a wide variety of projects dealing with innovative education can be created as people with ideas are able to interest people with funds. New projects are always being considered, both within the existing divisions and programs, and within as yet unexplored realms of the learning experience.*

**We can't put it together.**

**It is together.**

